

frontline

802.11

802.11 a/b/g/n PROTOCOL ANALYZER

Hardware and Software User Manual

Probe**Sync**

TELEDYNE LECROY

Copyright © 2017 Teledyne LeCroy, Inc.

FTS, Frontline, Frontline Test System, ComProbe Protocol Analysis System and ComProbe are registered trademarks of Teledyne LeCroy, Inc.

The following are trademarks of Teledyne LeCroy, Inc.

- ProbeSync™

The Bluetooth SIG, Inc. owns the Bluetooth® word mark and logos, and any use of such marks by Teledyne LeCroy, Inc. is under license.

All other trademarks and registered trademarks are property of their respective owners.

Contents

Chapter 1 Frontline Hardware & Software	1
1.1 What is in this manual	2
1.2 Computer Minimum System Requirements	2
1.3 Software Installation	2
Chapter 2 Getting Started	3
2.1 802.11 Hardware	3
2.1.1 Attaching Antennas	3
2.1.2 Connecting/Powering the Frontline 802.11	4
2.1.3 Setting Up for ProbeSync™	5
2.2 Data Capture Methods	7
2.2.1 Opening Data Capture Method	7
2.2.2 Frontline® 802.11 Data Capture Method	9
2.2.3 Virtual Sniffing	10
2.3 Control Window	10
2.3.1 Control Window Toolbar	11
2.3.2 Configuration Information on the Control Window	12
2.3.3 Status Information on the Control Window	12
2.3.4 Frame Information on the Control Window	13
2.3.5 Control Window Menus	13
2.3.6 Minimizing Windows	17
Chapter 3 Configuration Settings	19
3.1 802.11 Configuration	19
3.1.1 Wi-Fi Scanner Hardware Settings	19
3.1.2 802.11 I/O Settings - Datasource	19
3.1.3 Wi-Fi Device - MAC Address Editor	35
3.2 Decoder Parameters	36
3.2.1 Decoder Parameter Templates	38
3.2.2 Wi-Fi Security Decoder Parameters	40
3.2.3 Adding or Changing TCP/UDP Port Assignments	42
3.2.4 Determining Master and Slave	43

3.3 Conductive Testing	43
3.3.1 802.11 WiFi Conductive Testing	44
Chapter 4 Capturing and Analyzing Data	47
4.1 Capture Data	47
4.1.1 Air Sniffing: Positioning Devices	47
4.1.2 Capturing Data to Disk - General Procedure	49
4.1.3 Capturing Using Frontline Wi-Fi Datasource with Wireshark®	51
4.1.4 Combining BPA 600, 802.11, and HSU with ProbeSync	54
4.1.5 Soder & 802.11: Capturing with ProbeSync	56
4.1.6 Extended Inquiry Response	56
4.2 Protocol Stacks	57
4.2.1 Protocol Stack Wizard	58
4.2.2 Creating and Removing a Custom Stack	59
4.2.3 Reframing	60
4.2.4 Unframing	60
4.2.5 How the Analyzer Auto-traverses the Protocol Stack	61
4.2.6 Providing Context For Decoding When Frame Information Is Missing	62
4.3 Analyzing Protocol Decodes	62
4.3.1 The Frame Display	62
4.3.2 Coexistence View	97
4.4 Analyzing Byte Level Data	131
4.4.1 Event Display	131
4.4.2 The Event Display Toolbar	132
4.4.3 Opening Multiple Event Display Windows	133
4.4.4 Calculating CRCs or FCSs	133
4.4.5 Calculating Delta Times and Data Rates	134
4.4.6 Switching Between Live Update and Review Mode	134
4.4.7 Data Formats and Symbols	135
4.5 Data/Audio Extraction	139
4.6 Statistics	142
4.6.1 Statistics Window	142

4.6.2 Session, Resettable and Capture File Tabs	145
4.6.3 Copying Statistics To The Clipboard	146
4.6.4 802.11 Error Statistics	146
4.6.5 Graphs	146
4.6.5.2 Printing Error Graphs	147
Chapter 5 Navigating and Searching the Data	149
5.1 Find	149
5.1.1 Searching within Decodes	150
5.1.2 Searching by Pattern	152
5.1.3 Searching by Time	154
5.1.4 Using Go To	156
5.1.5 Searching for Special Events	157
5.1.6 Searching by Signal	158
5.1.7 Searching for Data Errors	162
5.1.8 Find - Bookmarks	164
5.1.9 Changing Where the Search Lands	165
5.1.10 Subtleties of Timestamp Searching	166
5.2 Bookmarks	166
5.2.1 Adding, Modifying or Deleting a Bookmark	166
5.2.2 Displaying All and Moving Between Bookmarks	167
Chapter 6 Saving and Importing Data	169
6.1 Saving Your Data	169
6.1.1 Saving the Entire Capture File	169
6.1.2 Saving the Entire Capture File with Save Selection	170
6.1.3 Saving a Portion of a Capture File	171
6.2 Adding Comments to a Capture File	171
6.3 Confirm Capture File (CFA) Changes	172
6.4 Loading and Importing a Capture File	172
6.4.1 Loading a Capture File	172
6.4.2 Importing Capture Files	173
6.5 Printing	173

6.5.1 Printing from the Frame Display/HTML Export	173
6.5.2 Printing from the Event Display	176
6.6 Exporting	177
6.6.1 Frame Display Export	177
6.6.2 Exporting a File with Event Display Export	177
Chapter 7 General Information	181
7.1 System Settings and Program Options	181
7.1.1 System Settings	181
7.1.2 Changing Default File Locations	185
7.1.3 Side Names	187
7.1.4 Timestamping	188
7.2 Technical Information	191
7.2.1 Performance Notes	191
7.2.2 Progress Bars	192
7.2.3 Event Numbering	192
7.2.4 Useful Character Tables	192
7.2.5 DecoderScript Overview	195
7.2.6 Bluetooth low energy ATT Decoder Handle Mapping	195
Contacting Technical Support	196
Appendices	199
Appendix A: Application Notes	200
A.1 ComProbe Automation Server: Why use it?	202
A.1.1 Automation Server Topology	203
A.1.2 Writing Automation Script	203
A.1.3 Running Automation Server Script	205
A.1.4 Saving Automation Captured Data	208
A.1.5 Keeping Track of Events	210
A.1.6 Automation Can Save Time and Money	210

Chapter 1 Frontline Hardware & Software

Frontline Test Equipment family of protocol analyzers work with the following technologies.

- Classic *Bluetooth*
- *Bluetooth* low energy
- Dual Mode *Bluetooth* (simultaneous Classic and low energy)
- *Bluetooth* Coexistence: *Bluetooth* with 802.11 Wi-Fi
- *Bluetooth* HCI (USB, SD, High Speed UART)
- NFC
- 802.11 (Wi-Fi)
- SD
- HSU (High Speed UART)

The Frontline hardware interfaces with your computer that is running our robust software engine called the ComProbe Protocol Analysis System or Frontline software. Whether you are sniffing the air or connecting directly to the chip Frontline analyzers use the same powerful Frontline software to help you test, troubleshoot, and debug communications faster.

Frontline software is an easy to use and powerful protocol analysis platform. Simply use the appropriate Frontline hardware or write your own proprietary code to pump communication streams directly into the Frontline software where they are decoded, decrypted, and analyzed. Within the Frontline software you see packets, frames, events, coexistence, binary, hex, radix, statistics, errors, and much more.

This manual is a user guide that takes you from connecting and setting up the hardware through all of the Frontline software functions for your Frontline hardware. Should you have any questions contact the [Frontline Technical Support Team](#).

1.1 What is in this manual

The Frontline User Manual comprises the following seven chapters. The chapters are organized in the sequence you would normally follow to capture and analyze data: set up, configure, capture, analyze, save. You can read them from beginning to end to gain a complete understanding of how to use the Frontline hardware and software or you can skip around if you only need a refresher on a particular topic. Use the Contents, Index, and Glossary to find the location of particular topics.

- **Chapter 1 Frontline Hardware and Software.** This chapter will describe the minimum computer requirements and how to install the software.
- **Chapter 2 Getting Started.** Here we describe how to set up and connect the hardware, and how to apply power. This chapter also describes how to start the Frontline software in Data Capture Methods. You will be introduced to the Control window that is the primary operating dialog in the Frontline software.
- **Chapter 3 Configuration Settings.** The software and hardware is configured to capture data. Configuration settings may vary for a particular Frontline analyzer depending on the technology and network being sniffed. There are topics on configuring protocol decoders used to disassemble packets into frames and events.
- **Chapter 4 Capturing and Analyzing Data.** This Chapter describes how to start a capture session and how to observe the captured packets, frames, layers and events.
- **Chapter 5 Navigating and Searching the Data.** Here you will find how to move through the data and how to isolate the data to specific events, often used for troubleshooting device design problems.
- **Chapter 6 Saving and Importing Data.** When a live capture is completed you may want to save the captured data for future analysis, or you may want to import a captured data set from another developer or for use in interoperability testing. This chapter will explain how to do this for various data file formats.
- **Chapter 7 General Information.** This chapter provides advanced system set up and configuration information, timestamping information, and general reference information such as ASCII, baudot, and EBCDIC codes. This chapter also provides information on how to contact Frontline's Technical Support team should you need assistance.

1.2 Computer Minimum System Requirements

Frontline supports the following computer systems configurations:

- Operating System: Windows 7/8/10
- USB Port: USB 2.0 High-Speed or later

The Frontline software must operate on a computer with the following minimum characteristics.

- Processor: Core i5 processor at 2.7 GHz
- RAM: 4 GB
- Free Hard Disk Space on C: drive: 20 GB

1.3 Software Installation

Download the installation software from [FTE.com](http://www.fte.com). Once downloaded, double-click the installer and follow the directions.

Use this link: <http://www.fte.com/80211-soft>.

Chapter 2 Getting Started

In this chapter we introduce you to the Frontline hardware and show how to start the Frontline analyzer software and explain the basic software controls and features for conducting the protocol analysis.

2.1 802.11 Hardware

2.1.1 Attaching Antennas

When you remove the Frontline 802.11 from the box, the first step is to attach the antennas (Figure 2.1).



Figure 2.1 - Front Panel

1. Attach an antenna to each front panel connector.



Figure 2.2 - Frontline 802.11 with both antennas attached

2.1.2 Connecting/Powering the Frontline 802.11

Once you have attached the antennas, the next step is to power up and connect the Frontline 802.11 to the computer.

1. Insert the power cable (DC connector) from the 12 volt AC adapter into the **Power** port on the Frontline 802.11 back panel (Figure 2.3).



Figure 2.3 - Back Panel - Power

2. Plug the 12 volt AC adapter into the AC power source. The front panel **Power** light illuminate (Figure 2.1).
3. Insert the USB cable into the **USB** port on the Frontline 802.11 back panel (Figure 2.4).



Figure 2.4 - Back Panel - USB

4. Insert the other end of the USB cable into the PC.
5. It may take as long as thirty seconds for Windows to recognize that the Frontline 802.11 hardware is connected to the PC. The **Activity** light on the Frontline 802.11 front panel (Figure 2.1 will blink during this period, when the light is steady, the Frontline 802.11 hardware is ready to communicate with the Frontline software.

2.1.3 Setting Up for ProbeSync™

The Frontline 802.11 hardware has ProbeSync™ which allows for synchronization of Frontline hardware clocks and timestamping. One Frontline device will act as the master device by providing the clock to the slave device receiving the clock. Do not confuse "master" and "slave" with the *Bluetooth* device master and slave relationships. Refer to the following tables.

Table 2.1 - 802.11₁ Synced to 802.11₂

802.11 ₁	802.11 ₂	802.11 ₁		802.11 ₂	
		OUT	IN	OUT	IN
Master	Slave	X			X
Slave	Master		X	X	

Table 2.2 - BPA 600 Synced to 802.11

BPA 600	802.11	BPA 600		802.11	
		OUT	IN	OUT	IN
Master	Slave	X			X

Note: The Frontline BPA 600 device must always be the master node in ProbeSync mode.

Table 2.3 - HSU Synced to 802.11

802.11	HSU	802.11		HSU	
		OUT	IN	OUT	IN
Master	Slave	X			X

Note: The Frontline HSU device must always be the slave node in ProbeSync mode, must always be the last device in the ProbeSync daisy-chain configuration.

ProbeSync allows a Frontline Sodera and a 802.11 hardware to be connected together to run off of a common clock, ensuring precise timestamp synchronization while capturing multiple wireless technologies such as *Bluetooth* and 802.11. One device will act as the *master* device by providing the clock to the *slave* device receiving the clock. The devices are connected in a daisy-chain configuration. Refer to the following table, to [Rear Panel Connectors, on page 1](#), and to [Connecting/Powering the Frontline 802.11 on page 4](#).

Table 2.4 - Sodera Synced to 802.11

Sodera	802.11	Sodera		802.11	
		PROBESYNC OUT	PROBESYNC IN	OUT	IN
Master	Slave	X			X

1. Using a CAT 5 Ethernet cable (less than 1.5 meters (4.9 feet)) insert one end to the master Frontline device OUT jack.
2. Insert the other end of the cable into the slave Frontline device IN jack.



Figure 2.5 - Back Panel - ProbeSync with BPA 600

2.2 Data Capture Methods

This section describes how to load TELEDYNE LECROY Frontline Protocol Analysis System software, and how to select the data capture method for your specific application.

2.2.1 Opening Data Capture Method

On product installation, the installer creates a folder on the windows desktop labeled "Frontline <version #>".

1. Double-click the " Frontline <version #>" desktop folder

This opens a standard Windows file folder window.

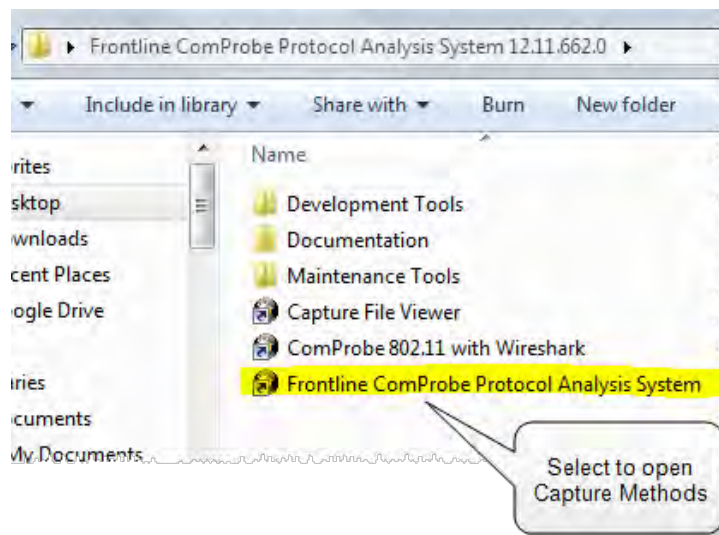

Figure 2.6 - Desktop Folder Link

2. Double-click on Frontline ComProbe Protocol Analysis System and the system displays the **Select Data Capture Method...** dialog.

Note: You can also access this dialog by selecting Start > All Programs > Frontline (Version #) > Frontline ComProbe Protocol Analysis System

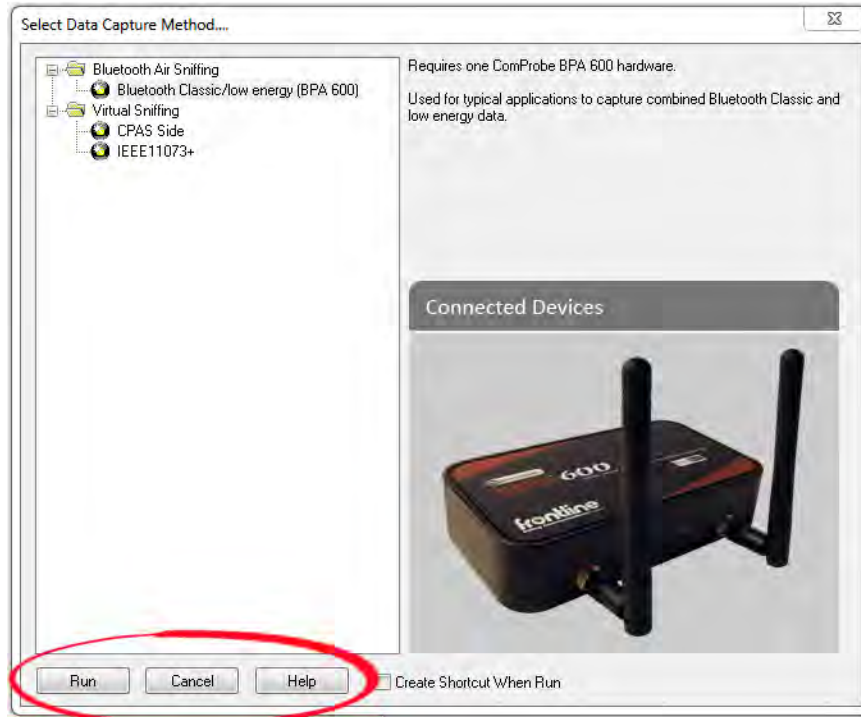

Figure 2.7 - Example: Select Data Capture Method..., BPA 600

Three buttons appear at the bottom of the dialog; **Run**, **Cancel**, and **Help**.

Select Data Capture Method dialog buttons

Button	Description
	Becomes active when a capture method is selected. Starts the selected capture method.
	Closes the dialog and exits the user back to the computer desktop.
	Opens Frontline Help. Keyboard shortcut: F1.

- Expand the folder and select the data capture method that matches your configuration.
- Click on the Run button and the Frontline Control Window will open configured to the selected capture method.

Note: If you don't need to identify a capture method, then click the Run button to start the analyzer.

Creating a Shortcut



A checkbox labeled **Create Shortcut When Run** is located near the bottom of the dialog. This box is un-checked by default. Select this checkbox, and the

system creates a shortcut for the selected method, and places it in the "Frontline ComProbe Protocol Analysis System <version#>" desktop folder and in the start menu when you click the Run button. This function allows you the option to create a shortcut icon that can be placed on the desktop. In the future, simply double-click the shortcut to start the analyzer in the associated protocol.

Supporting Documentation

The Frontline <version #> directory contains supporting documentation for development (Automation, DecoderScript™, application notes), user documentation (Quick Start Guides and the Frontline User Manual), and maintenance tools.

2.2.2 Frontline® 802.11 Data Capture Method

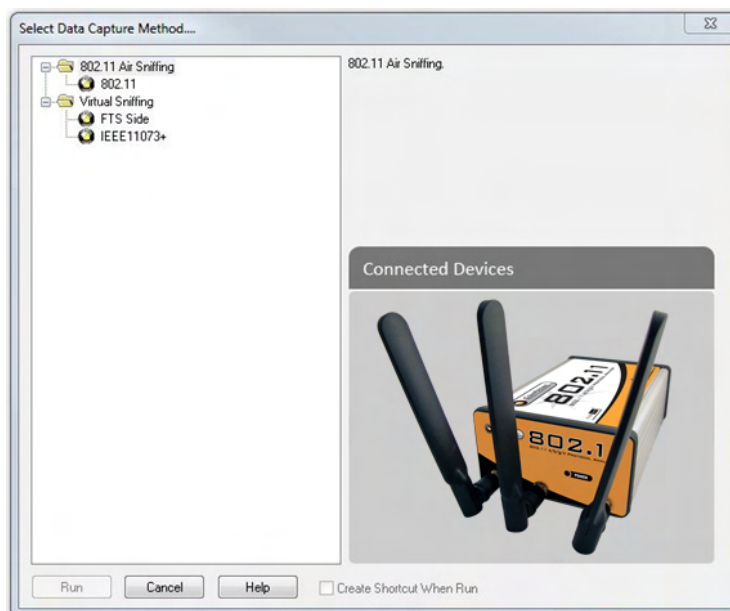

- 802.11
 - Requires one Frontline 802.11 hardware.
 - Captures 802.11 data on the selected channel.

- 802.11 Double
 - Requires two Frontline 802.11 hardware with ProbeSync™.



- 802.11 Triple
 - Requires three Frontline 802.11 hardware with ProbeSync™.
- 802.11 with USB
 - Requires one Frontline 802.11 and one Frontline USB hardware.
- 802.11 with USB and SD
 - Requires one Frontline 802.11, one Frontline USB, and one Frontline SD hardware.

2.2.3 Virtual Sniffing

The Virtual Sniffer is a live import facility within Frontline® software that makes it possible to access any layer in a stack that the programmer has access to and feed this data into the Virtual Sniffer. Please refer to the “Show Live Import Information” button on the Virtual Sniffer Datasource window in Frontline software. More information is available in the Live Import Developer’s Kit located in the Development Tools folder in Frontline Protocol Analysis System desktop folder, and a white paper is available at [Bluetooth Virtual Sniffing](#)

- **FTS Side**
 - No hardware required.
 - Frontline software acquires data via user-developed software.
- **IEEE 11073+**
 - No hardware required
 - for sniffing data virtually from the continua Enabling Software Library (CESL) IEEE 11073 tester.

2.3 Control Window

The analyzer displays information in multiple windows, with each window presenting a different type of information. The Control window opens when the **Run** button is clicked in the **Select Data Capture Method** window. The Control window provides access to each Frontline analyzer functions and settings as well as a brief overview of the data in the capture file. Each icon on the toolbar represents a different data analysis function.

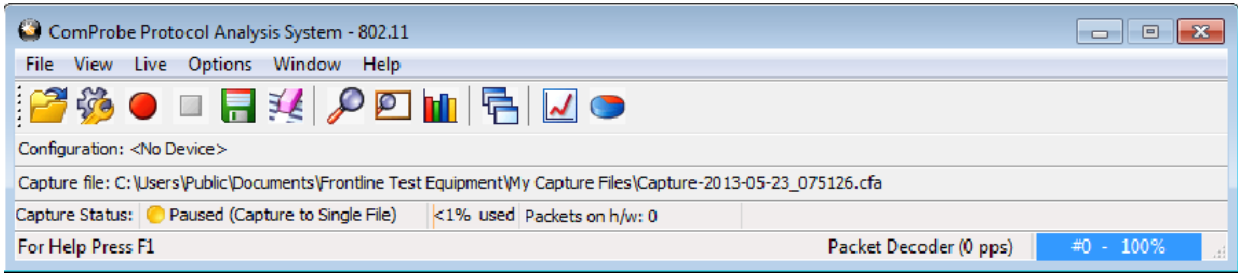



Figure 2.8 - Control Window

Because the Control window can get lost behind other windows, every window has a **Home** icon  that brings the Control window back to the front. Just click on the **Home** icon to restore the Control window.

When running the **Capture File Viewer**, the Control window toolbar and menus contain only those selections needed to open a capture file and display the About box. Once a capture file is opened, the analyzer limits Control window functions to those that are useful for analyzing data contained in the current file. Because you cannot capture data while using **Capture File Viewer**, data capture functions are unavailable. For example, when viewing Ethernet data, the Signal Display is not available. The title bar of the Control window displays the name of the currently open file. The status line (below the toolbar) shows the configuration settings that were in use when the capture file was created.

2.3.1 Control Window Toolbar

Toolbar icon displays vary according to operating mode and/or data displayed. Available icons appear in color, while unavailable icons are not visible. Grayed-out icons are available for the Frontline hardware and software configuration in use but are not active until certain operating conditions occur. All toolbar icons have corresponding menu bar items or options.

Table 2.5 - Control Window Toolbar Icons













Icon	Description
	Open File - Opens a capture file.
	I/O Settings - Opens settings
	Start Capture - Begins data capture to disk
	Stop Capture - Available after data capture has started. Click to stop data capture. Data can be reviewed and saved, but no new data can be captured.
	Save - Saves the capture file.
	Clear - Clears or saves the capture file.
	Event Display - (framed data only) Opens a Event Display, with the currently selected bytes highlighted.

Table 2.5 - Control Window Toolbar Icons (continued)

Icon	Description
	Frame Display - (framed data only) Opens a Frame Display, with the frame of the currently selected bytes highlighted.
	Notes - Opens the Notes dialog.
	Cascade - Arranges windows in a cascaded display.
	Coexistence View - Opens the Coexistence View dialog.
	Wi-Fi Error Statistics - Opens the Wi-Fi Error Statistics dialog.

2.3.2 Configuration Information on the Control Window

The Configuration bar (just below the toolbar) displays the hardware configuration and may include I/O settings. It also provides such things as name of the network card, address information, ports in use, etc.

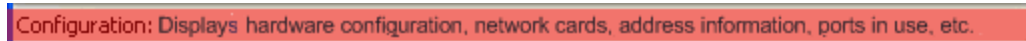

2.3.3 Status Information on the Control Window

The Status bar located just below the Configuration bar on the **Control** window provides a quick look at current activity in the analyzer.



- Capture Status displays Not Active, Paused or Running and refers to the state of data capture.
 - Not Active means that the analyzer is not currently capturing data.
 - Paused means that data capture has been suspended.
 - Running means that the analyzer is actively capturing data.

- % Used

The next item shows how much of the buffer or capture file has been filled. For example, if you are capturing to disk and have specified a 200 Kb capture file, the bar graph tells you how much of the capture file has been used. When the graph reaches 100%, capture either stops or the file begins to overwrite the oldest data, depending on the choices you made in the [System Settings](#).

- Utilization/Events

The second half of the status bar gives the current utilization and total number of events seen on the network. This is the total number of events monitored, not the total number of events captured. The

analyzer is always monitoring the circuit, even when data is not actively being captured. These graphs allow you to keep an eye on what is happening on the circuit, without requiring you to capture data.

2.3.4 Frame Information on the Control Window

Frame Decoder information is located just below the Status bar on the Control window. It displays two pieces of information.

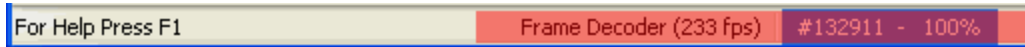

- Frame Decoder (233 fps) displays the number of frames per second being decoded. You can toggle this display on/off with Ctrl-D, but it is available only during a live capture.
- #132911 displays the total frames decoded.
- 100% displays the percentage of buffer space used.

2.3.5 Control Window Menus

The menus appearing on the **Control** window vary depending on whether the data is being captured live or whether you are looking at a [.cfa file](#). The following tables describe each menu.

Table 2.6 - Control Window **File** Menu Selections

Mode	Selection	Hot Key	Description
Live	Close		Closes Live mode.
Capture File	Go Live		Returns to Live mode
	Reframe		If you need to change the protocol stack used to interpret a capture file and the framing is different in the new stack, you need to reframe in order for the protocol decode to be correct. See Reframing on page 60
	Unframe		Removes start-of-frame and end-of-frame markers from your data. See Unframing on page 60
	Recreate Companion File		This option is available when you are working with decoders. If you change a decoder while working with data, you can recreate the ".frm file", the companion file to the ".cfa file". Recreating the ".frm file" helps ensure that the decoders will work properly.
	Reload Decoders		The plug-ins are reset and received frames are decoded again.

Table 2.6 - Control Window File Menu Selections (continued)

Mode	Selection	Hot Key	Description
Live & Capture File	Open Capture File	Ctrl-O	Opens a Windows Open file dialog. at the default location "...\\Public Documents\\Frontline Test Equipment\\My Capture Files\\". Capture files have a .cfa extension.
	Save	Ctrl-S	Saves the current capture or capture file. Opens a Windows Save As dialog at the default location "...\\Public Documents\\Frontline Test Equipment\\My Capture Files\\".
	Exit ComProbe Protocol Analysis System		Shuts down the ComProbe Protocol Analysis System and all open system windows.
	Recent capture files		A list of recently opened capture files will appear.

The **View** menu selections will vary depending on the Frontline analyzer in use.

Table 2.7 - Control Window **View** Menu Selections

Mode	Selection	Hot key	Description
Live & Capture File	Event Display	Ctrl-Shift-E	Opens the Event Display window for analyzing byte level data.
	Frame Display	Ctrl-Shift-M	Opens the Frame Display window for analyzing protocol level data
	Statistics	Ctrl-Shift-S	Opens the Statistics Window that shows information about packet throughput.
	Coexistence View		Opens the Coexistence View window that can simultaneously display Classic <i>Bluetooth</i> , <i>Bluetooth</i> low energy, and 802.11 packets and throughput.
	Wi-Fi Error Statistics		Opens the Wi-Fi Error Statistics window that displays the number of packet errors.

Table 2.8 - Control Window **Edit** Menu Selections

Mode	Selection	Hot-key	Description
Capture File	Notes	Ctrl-Shift-O	Opens the Notes window that allows the user to add comments to a capture file.

The **Live** menu selections will vary depending on the Frontline analyzer in use.

Table 2.9 - Control Window **Live** Menu Selections

Mode	Selection	Hot-Key	Description
The following two rows apply to all Frontline products except Set in Target.			
Live	Start Capture	Shift-F5	Begins data capture from the configured wireless devices.
	Stop Capture	F10	Stops data capture from the configured wireless devices.
The following rows apply to all Frontline products			
Live	Clear	Shift-F10	Clears or saves the capture file.

Table 2.9 - Control Window Live Menu Selections (continued)

Mode	Selection	Hot-Key	Description
Live & Capture File	Hardware Settings		0 - Classic 1 - <i>Bluetooth</i> low energy
	I/O Settings		0 - Classic 1 - <i>Bluetooth</i> low energy
	System Settings	Alt-Enter	Opens the System Settings dialog for configuring capture files.
	Directories...		Opens the File Locations dialog where the user can change the default file locations.
	Check for New Releases at Startup		When this selection is enabled, the program automatically checks for the latest Frontline protocol analyzer software releases.
	Side Names...		Opens the Side Names dialog used to customize the names of the slave and master wireless devices.
	Protocol Stack...		Opens the Select a Stack dialog where the user defines the protocol stack they want the analyzer to use when decoding frames.
	Set Initial Decoder Parameters...		Opens the Set Initial Decoder Parameters window . There may be times when the context for decoding a frame is missing. For example, if the analyzer captured a response frame, but did not capture the command frame, then the decode for the response may be incomplete. The Set Initial Decoder Parameters dialog provides a means to supply the context for any frame. The system allows the user to define any number of parameters and save them in templates for later use. Each entry in the window takes effect from the beginning of the capture onward or until redefined in the Set Subsequent Decoder Parameters dialog. This selection is not present if no decoder is loaded that supports this feature.
	Set Subsequent Decoder Parameters...		Opens the Set Subsequent Decoder Parameters dialog where the user can override an existing parameter at any frame in the capture. Each entry takes effect from the specified frame onward or until redefined in this dialog on a later frame. This selection is not present if no decoder is loaded that supports this feature.
	Automatically Request Missing Decoder Information		When checked, this selection opens a dialog that asking for missing frame information. When unchecked, the analyzer decodes each frame until it cannot go further and it stops decoding. This selection is not present if no decoder is loaded that supports this feature.

Table 2.9 - Control Window Live Menu Selections (continued)

Mode	Selection	Hot-Key	Description
	Enable/Disable Audio Expert System		When enabled, the Audio Expert System is active, other wise it is not available. Only available when an Audio Expert System licensed device is connected.

The **Windows** menu selection applies only to the **Control** window and open analysis windows: **Frame Display**, **Event Display**, **Message Sequence Chart**, **Bluetooth Timeline**, **Bluetooth low energy Timeline**, and **Coexistence View**. All other windows, such as the datasource, are not affected by these selections.

Table 2.10 - Control Window **Windows** Menu Selections

Mode	Selection	Hot-Key	Description
Live & Capture File	Cascade	Ctrl-W	Arranges open analysis windows in a cascaded view with window captions visible.
	Close All Views		Closes Open analysis windows.
	Minimize Control Minimizes All		When checked, minimizing the Control window also minimizes all open analysis windows.
	Frame Display and Event Display		When these windows are open the menu will display these selections. Clicking on the selection will bring that window to the front.

Table 2.11 - Control Window **Help** Menu Selections

Mode	Selection	Hot-Key	Description
Live & Capture File	Help Topics		Opens the Frontline Help window.
	About Frontline Protocol Analysis System		Provides a pop-up showing the version and release information, Frontline contact information, and copyright information.
	Support on the Web		Opens a browser to fte.com technical support page.

2.3.6 Minimizing Windows

Windows can be minimized individually or as a group when the **Control** window is minimized. To minimize windows as a group:

1. Go to the **Window** menu on the Control  window.
2. Select **Minimize Control Minimizes All**. The analyzer puts a check next to the menu item, indicating that when the Control window is minimized, all windows are minimized.
3. Select the menu item again to deactivate this feature.
4. The windows minimize to the top of the operating system Task Bar.

Chapter 3 Configuration Settings

In this section the Frontline software is used to configure an analyzer for capturing data .

3.1 802.11 Configuration

3.1.1 Wi-Fi Scanner Hardware Settings

The Hardware Settings dialog provides the ability to select a device to sniff/scan. The dialog only lists devices with a MAC address that match the Frontline devices. To access the Hardware Settings dialog:

1. Select Hardware Settings from the Options menu on the 802.11 Control window.

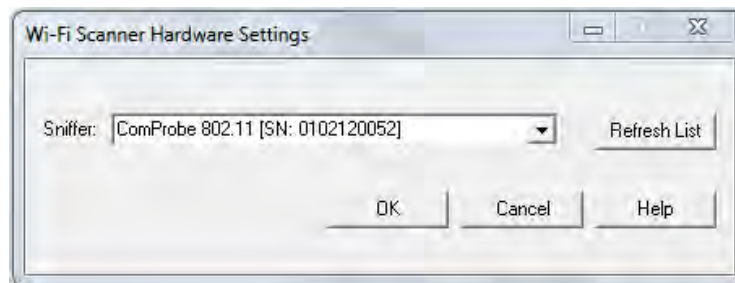

Figure 3.1 - Wi-Fi Scanner Hardware Settings Dialog

2. Select a device from the drop-down list.
3. Select OK

If no devices are found, the list is blank.

Note: Upon launching the Air Sniffer, the first device in the drop-down is the default device.

3.1.2 802.11 I/O Settings - Datasource

1. Select **I/O Settings** from the **Options** menu on the **Control** window.

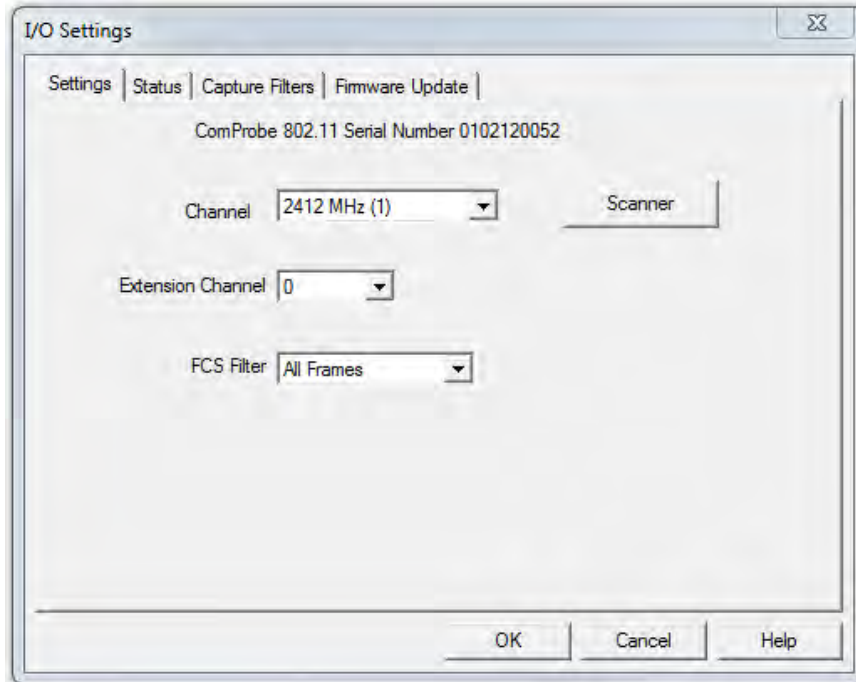

Figure 3.2 - 802.11 I/O Settings Dialog

There are several things to remember about **I/O Settings**:

- The **I/O Settings** are specific to the device selected in the **Hardware Settings**.
- Two 802.11 devices attached to a computer have different settings.
- Changing the settings changes the devices' default settings.
- If a parameter is changed (e.g. Channel 1 is changed to 6), the new setting appears the next time the **I/O Settings** dialog is opened for the device.
- The settings are saved when the **OK** button is pressed.

3.1.2.1 Settings

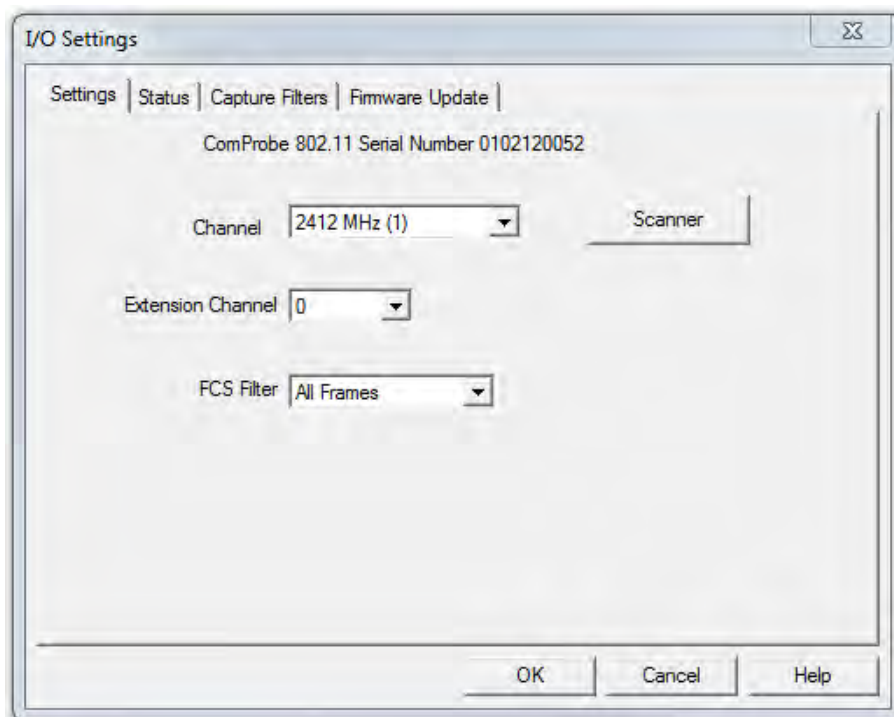

Figure 3.3 - 802.11 I/O Settings Settings Tab

The Settings dialog allows you to change and observe basic configuration values. These include the **Channel**, **Extension Channel**, **FCS Filter** and **Capture Type**.

- **Channel** - Select the channel from the drop-down list. Channels have been extended to the 5Ghz range.
- **Extension**- allows you to extend the range of channels available
 - 0 = Standard 1-14 Wi-Fi channels
 - -1 = Expanded channels below the standard range
 - +1 = Expanded channels above the standard range
- **FCS Filter** - The Frame Check Sequence filter indicates if the device should capture frames with an invalid FCS. Select **All Frames** or **Valid Frames**

Clicking on the **Scanner** button will open the **Wi-Fi Scanner** dialog. This action is useful if you do not know the channel to sniff. Once you have selected a channel in the **Wi-Fi Scanner** dialog and confirmed your selection the selected channel will appear in **Channel**.

3.1.2.2 Status

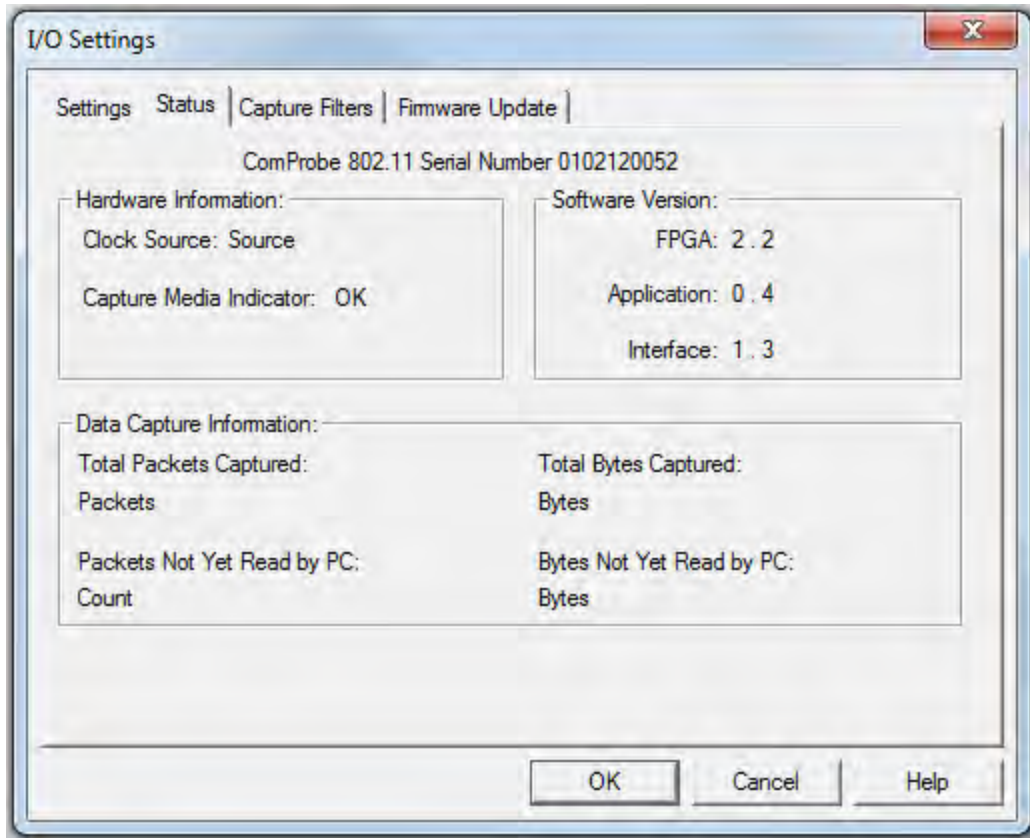

Figure 3.4 - 802.11 I/O Settings Status Tab

The Status dialog provides current information about the ComProbe device. There are no settings for this dialog.

3.1.2.3 Capture Filters

The **Capture Filters** dialog allows you create, modify, and delete capture filters. The dialog initially displays the existing MAC address Capture Filters.

- To activate the capture filters and to be able to create/modify additional filters, you first must select the **Enable MAC Address Capture Filters** check box.
- You can select/deselect which filters are active by checking/unchecking the **Enable** checkbox in the first column in the table.
- You can also select to ignore **Management, Control, Data, and Reserved** frame types by selecting one or more the checkboxes.

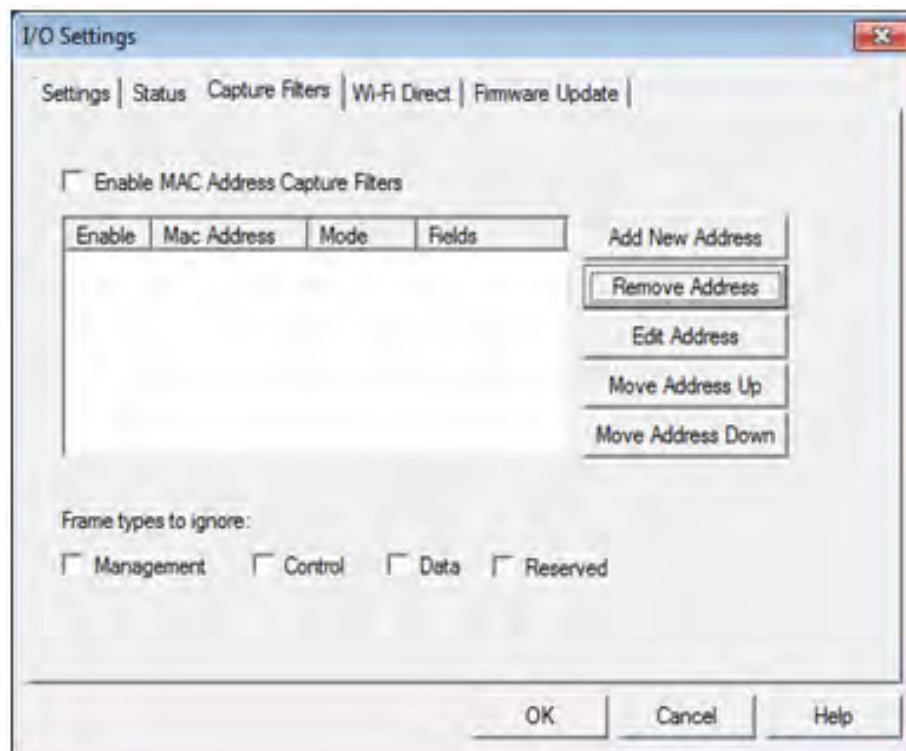

Figure 3.5 - 802.11 I/O Settings Capture Filters Tab

To create a key, select one of the following options:

- **Add New Address** - displays a text box where you can enter the address

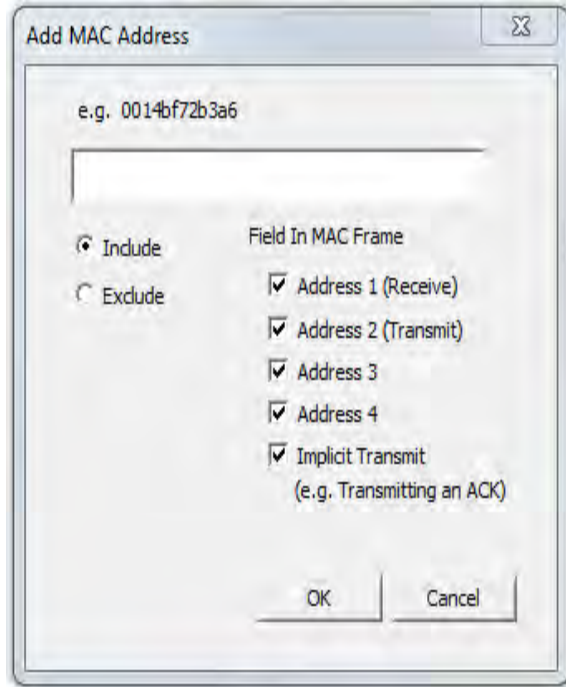

Figure 3.6 - 802.11 I/O Settings Capture Filters Add New Address Dialog

1. Enter a MAC Address in the text field.
2. Select the **Include** radio button to only capture packets with this MAC address.
3. Select the **Exclude** radio button to capture packets with other filters, but not ones with this MAC address.
4. Select one or more check boxes to identify which fields in the MAC Frame to include.

The MAC header for an 802.11 frame can contain up to 4 address fields. Most frames do not have that many. In general, the first address is the intended receiver and the second address is the device that transmits the frame. The third and fourth address fields depend on the context of the frame. Some of the control type frames do not include the transmitter address but they may be determined from previous frames.

5. Select **OK** to close the dialog.

Once you have MAC addresses on the main dialog, you can modify them using four options.

- **Remove Address** - Highlight an address that you want to delete and select Remove Address to remove it from the list.
- **Edit Address** - Highlight an address that you want to edit and select Edit to bring up a dialog where you can edit the address. The address and any of the prior settings may be changes. Click **OK** to save and close.

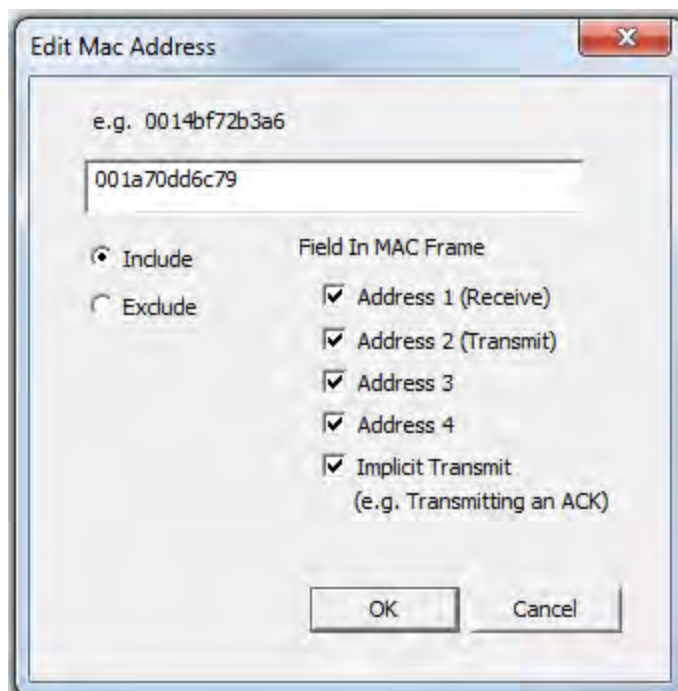

Figure 3.7 - 802.11 I/O Settings Capture Filters Edit MAC Address Dialog

- **Move Address Up** - moves the selected address up in the queue.
- **Move Address Down** - moves the selected address down in the queue.

3.1.2.4 Firmware Update

To take full advantage of the improvements to the ComProbe 802.11 with ComProbe Protocol Analysis System you must update the firmware on the ComProbe.

Note: With the release of ComProbe Protocol Analysis System (CPAS) version 15.11.8698.9035 in December 2015, an update to the firmware is required upon installation of the software. For that version, the full update requires three complete passes through the update process followed by a power cycle of the ComProbe 802.11. Subsequent firmware updates may not require three firmware update cycles. This procedure is designed to take you through one to three firmware update cycles. Follow the procedure carefully, paying attention to jumps around unnecessary steps, and you should have no difficulty updating the firmware.

1. This tab displays the current firmware version in the hardware. You can check for the firmware updates by first noting the current version and then clicking on the **Check For Updates** button.

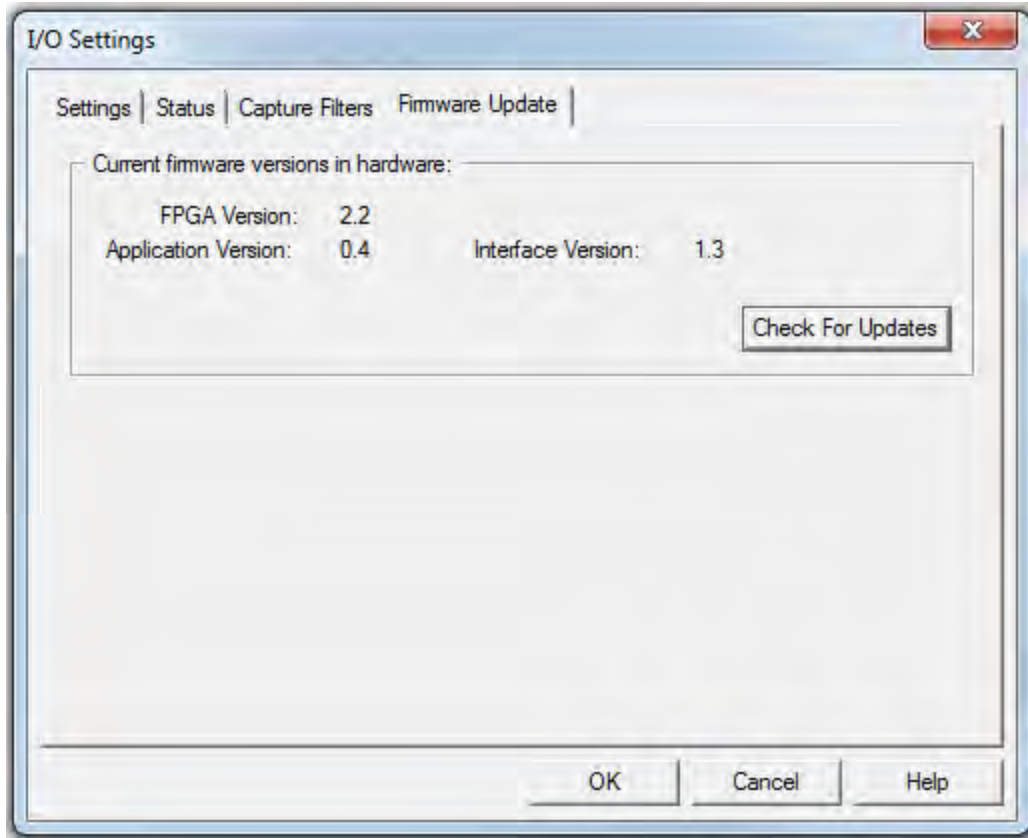

Figure 3.8 - 802.11 I/O Settings Firmware Update Tab

2. The **Check for Updates** dialog will open. If an update is available you can install it by clicking on the **Start Update** button.

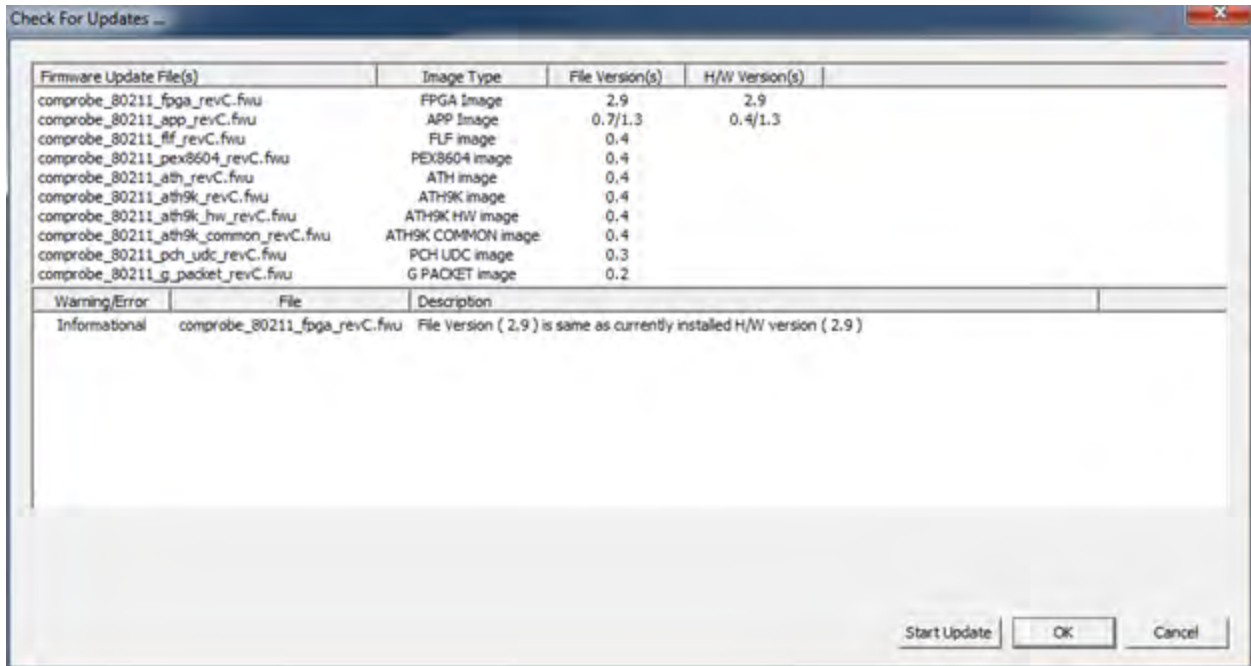

Figure 3.9 - 802.11 I/O Settings Firmware Check For Updates

3. When the update is complete, two situations can occur.
 - a. If more firmware updates are required the following dialog will appear. Click on OK, and continue to step 4.

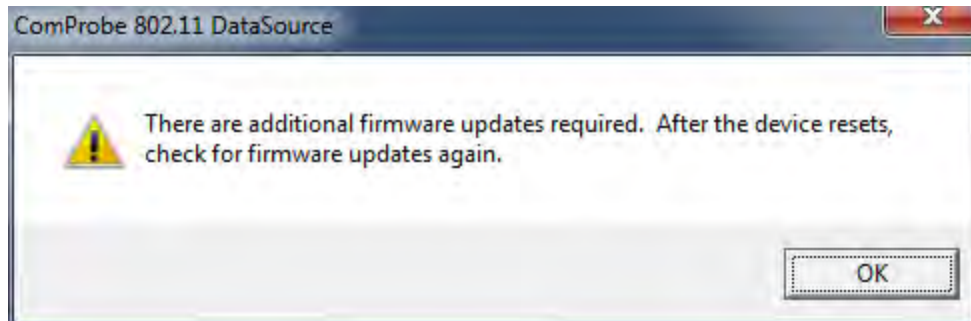

Figure 3.10 - 802.11 I/O Settings Check for Updates Again, second cycle.

- b. If there are no more firmware updates, continue to step 15.
4. Click **OK** on the **Check for Updates** dialog.
5. Click **Cancel** on the **I/O Settings** dialog **Settings** tab (See [Settings on page 20](#)). The ComProbe 802.11 will reset. Wait for a solid **Activity** LED on the ComProbe hardware .
6. Once the ComProbe 802.11 has reset, select **I/O Settings** from the Control Window **Options** menu.
7. Click on the **I/O Settings** dialog **Firmware Update** tab and then click on the **Check for Updates** button. The Check for Updates dialog will appear.

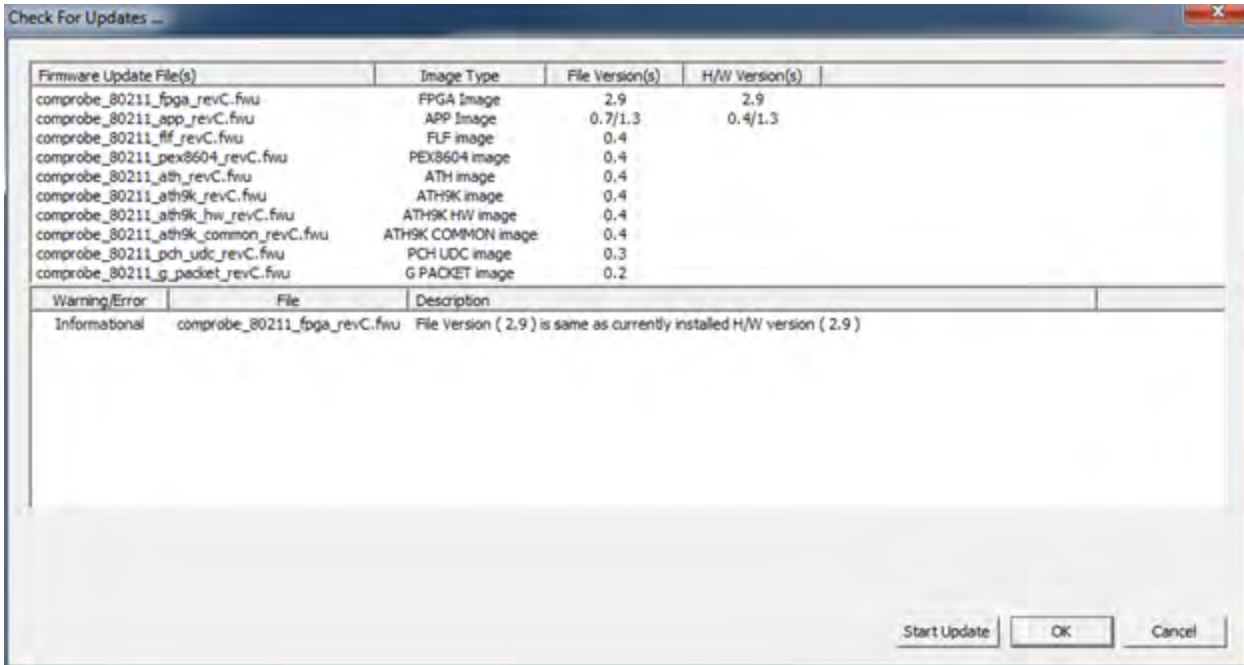

Figure 3.11 - 802.11 I/O Settings Firmware Check For Updates, second cycle.

8. Click the **Start Update** button.
9. Again, when the update is complete, two situations can occur.
 - a. If there are more firmware updates the following dialog will be displayed. Click on **OK** and continue to step 10.

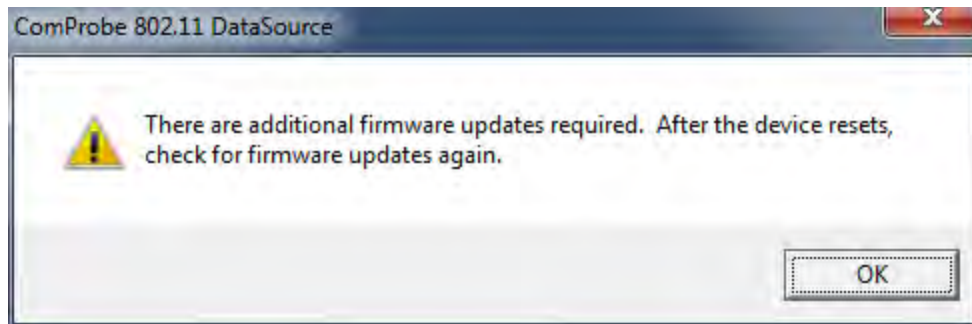

Figure 3.12 - 802.11 I/O Settings Check for Updates Again, third cycle.

- b. If there are no more firmware updates, continue to step 15.
10. Click **OK** on the **Check for Updates** dialog.
11. Click **Cancel** on the **I/O Settings** dialog **Settings** tab (See [Settings on page 20](#)). The ComProbe 802.11 will reset. Wait for a solid **Activity** LED on the ComProbe hardware .
12. Once the ComProbe 802.11 has reset, select **I/O Settings** from the Control Window **Options** menu.
13. Click on the **I/O Settings** dialog **Firmware Update** tab and then click on the **Check for Updates** button. The **Check for Updates** dialog will appear again.

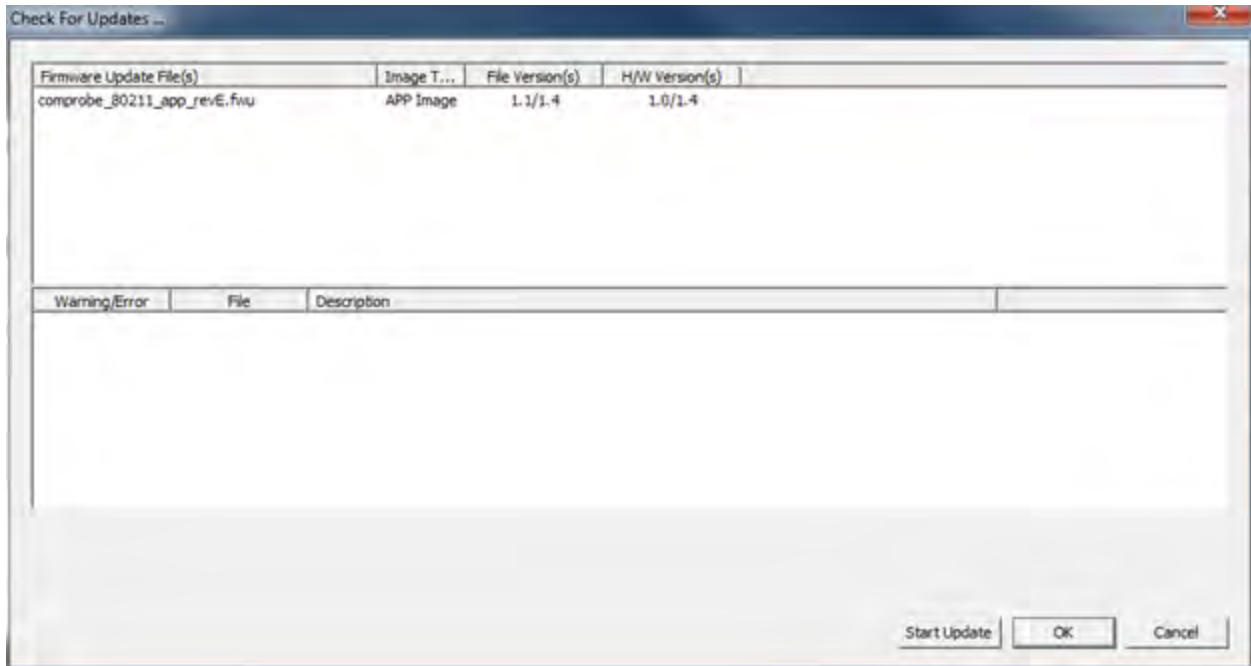

Figure 3.13 - 802.11 I/O Settings Firmware Check For Updates, third cycle.

14. Click the **Start Update** button.
15. When the update is complete the **OK** button will be enabled. Click the **OK** button.
16. When the **I/O Settings** dialog appears, click the **OK** button. The ComProbe 802.11 will reset. Reset is complete when the ComProbe 802.11 unit serial number appears in the Control Window Configuration Information.

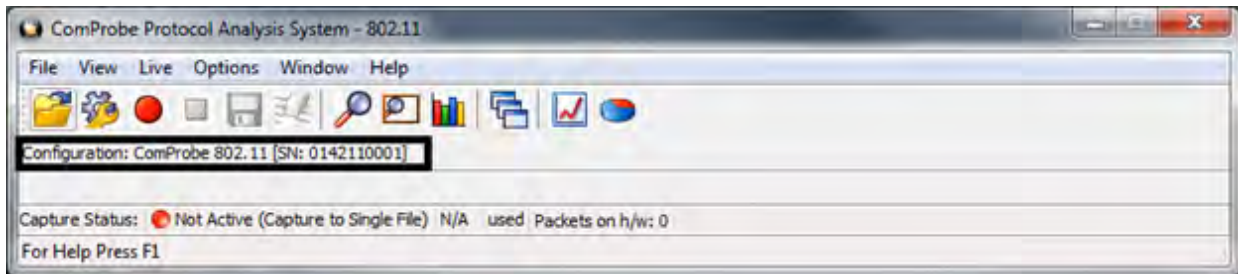

Figure 3.14 - ComProbe 802.11 Unit Reset Complete Indication

17. Remove power from the ComProbe 802.11 unit, and then reapply power. Wait until the **Activity** LED comes back on and resume normal ComProbe operation. When the ComProbe 802.11 serial number shows in the Control Window again, the firmware update is complete.

3.1.2.5 WiFi Security

With ComProbe 802.11, the WiFi decryption is not done in the datasource. It is done in the decoders, so you must go to **Set Initial Decoder Parameters** to provide the security information to the decoder.

From the Control window, select **Set Initial Decoder Parameters...** from the **Options** menu.

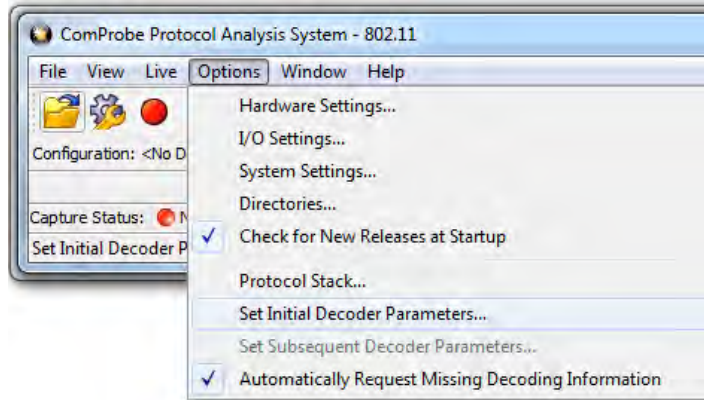

In the **Set Initial Decoder Parameters** dialog, select the **Security** tab. In the tab pane, select the encryption method being using with your device under test (DUT) by clicking on the radio button in the **Encrypted Data** box.

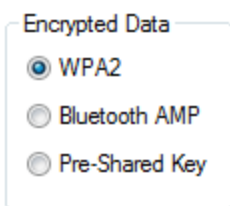
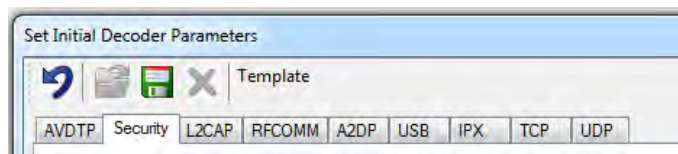

There are three types of types of encrypted data on the security tab, each one selectable via a radio button.

Table 3.1 - WiFi Encrypted Data Options

Option	Description
WPA2	WPA2 (Wi-Fi Protected Access), and WEP (Wired Equivalent Privacy) data that is transmitted over a 802.11 communications link. There are two values you have to enter for the WPA2 and WEP to be decrypted properly.
Bluetooth AMP	The <i>Bluetooth</i> alternative MAC/PHY (AMP) enables <i>Bluetooth</i> to support data rates up to 24 Mbps by using additional wireless radio technologies.
Pre-shared Key	The pre-shared key is a 32-byte hex number.

Within the **Set Initial Decoder Parameters...** dialog **Security** tab, the fields available will depend on the **Encrypted Data** option selected.

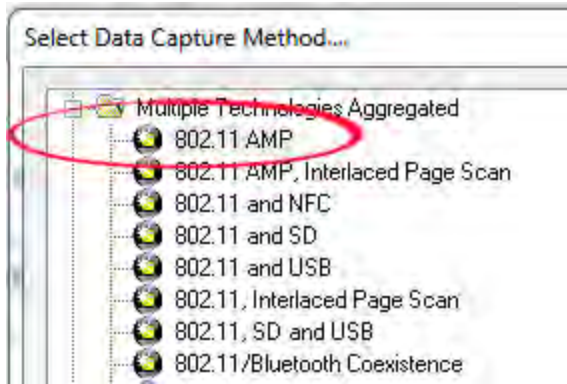

Note: When capturing both *Bluetooth* and 802.11 data using the **802.11AMP** capture method, the ComProbe software uses the link from the BR/EDR connection. To automatically decode 802.11 AMP frames in this case, select the **Bluetooth AMP Encrypted Data**, but leave the **Link Key** field blank.

Table 3.2 - WiFi Encrypted Data Option Fields

Encrypted Data Option	Field	Description
WPA2	WPA2: SSID	The station ID of the 802.11 communications link.
	WEP: SSID	The station ID of the 802.11 communications link.
	WEP: Passkey	The shared passkey phrase used in communications.
Bluetooth AMP	BDR/EDR Link Key	Enter a hexadecimal value for the BR/EDR Link Key . (See Note above).
	WEP: SSID	The station ID of the 802.11 communications link.
	WEP: Passkey	The shared passkey phrase used in communications.
Pre-Shared Key	Raw Hex Key	Enter a 32-byte hex number
	WEP: SSID	The station ID of the 802.11 communications link.
	WEP: Passkey	The shared passkey phrase used in communications.

Enter the required security data in to the active fields for the selected Encrypted Data option. Click the **OK** button to set the decoder security parameters.

Wi-Fi security settings are also presented in detail in the Decoder Parameters section (See [Wi-Fi Security Decoder Parameters on page 40](#)).

3.1.2.6 Device Scanner

3.1.2.6.1 Wi-Fi Device Scanner

1. On the **I/O Settings** dialog click on the **Settings** tab, and then click on the Scanner button. The **Wi-Fi Device Scanner** dialog will open.

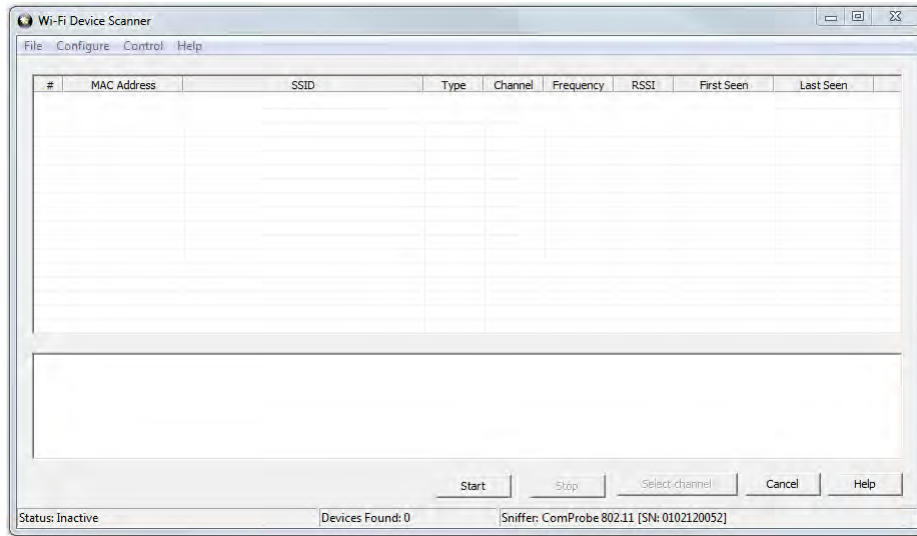

Figure 3.15 - 802.11 Device Scanner with no Devices Detected

2. On the **Wi-Fi Device Scanner** dialog Select the **Start** button or select **Start Scanning** from the **Control** menu to begin populating the list .

The **Wi-Fi Device Scanner** dialog displays a list of discoverable Wi-Fi devices in a table. The devices are identified by:

- MAC Address
- SSID
- Type
- Channel
- Frequency
- [RSSI](#)
- First Seen
- Last Seen

Note: You can select the **Stop** or **Stop Scanning** from the **Configure** menu anytime to stop the device search.

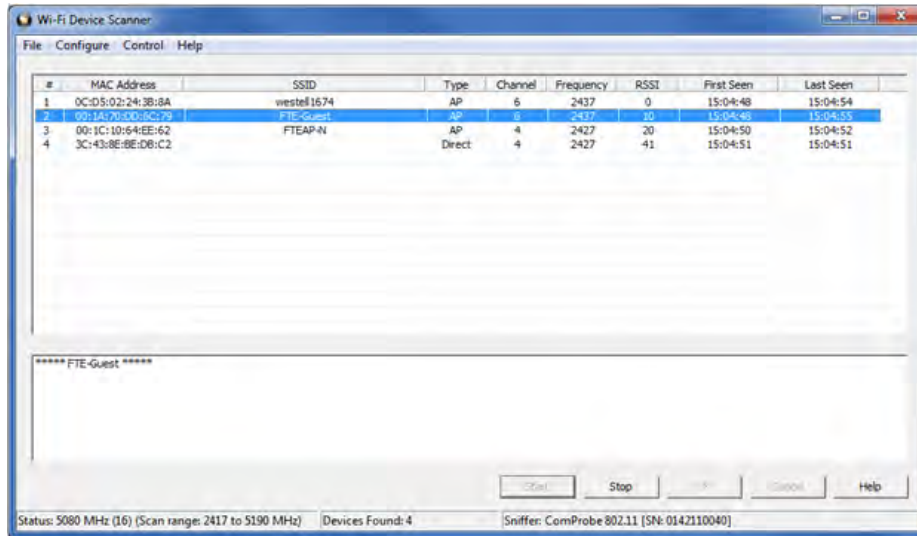
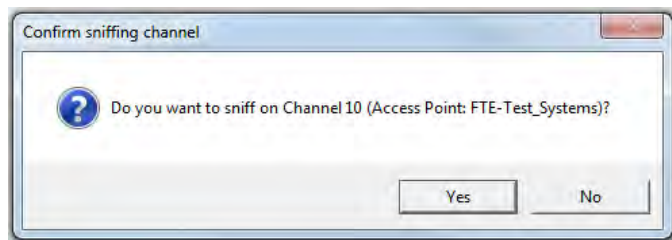

Figure 3.16 - 802.11 Device Scanner with Devices Detected

3. Select the device.
4. Click on **Select channel <no>**, where <no> is the channel number selected. The **Confirm Sniffing Channel** confirmation will appear. Click on **Yes** will close the **Wi-Fi Device Scanner** and the ComProbe analyzer will use the selected channel.



File Menu

Under the File menu you can select **Export to file** which converts the information in the table to a text file.

1. Select **Export to CSV file**. The **Save As** menu appears
2. Select where you want to save the file in **Save in**.
3. Enter a **File Name**.
4. Select **Save**.

Configure

From the Configure menu you can select , [Hardware Settings](#) and [I/O Settings](#)

3.1.2.6.2 Wi-Fi Scanner Hardware Settings

The Hardware Settings dialog provides the ability to select a device to sniff/scan. The dialog only lists devices with a MAC address that match the Frontline devices. To access the Hardware Settings dialog:

1. Select Hardware Settings from the Options menu on the 802.11 Control window.

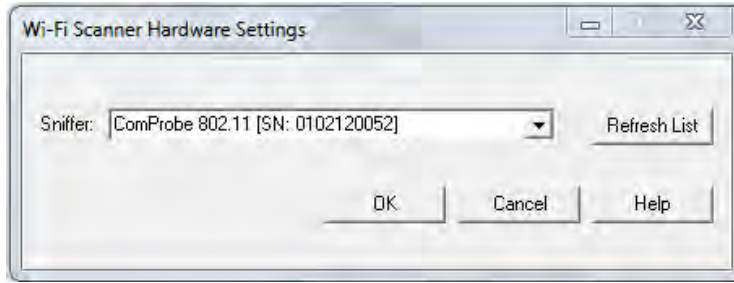

Figure 3.17 - Wi-Fi Scanner Hardware Settings Dialog

2. Select a device from the drop-down list.
3. Select OK

If no devices are found, the list is blank.

Note: Upon launching the Air Sniffer, the first device in the drop-down is the default device.

3.1.2.6.3 Wi-Fi Device Scanner - I/O Settings

The Device Scanner I/O Settings dialog is used to set a listening time and to activate a probe request. To access the I/O Settings dialog:

1. Select **I/O Settings** from the Configure menu on the [Wi-Fi Device Scanner](#) window.

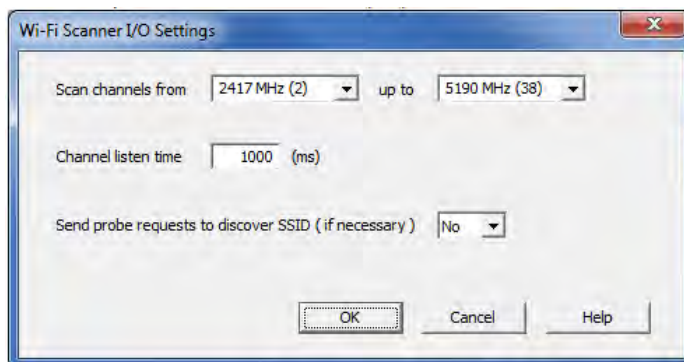

Figure 3.18 - Wi-Fi Device Scanner I/O Settings Dialog

2. **Scan Channels from:** Pick a lower and upper limit to scan a specific subset of frequencies. By default all channels are selected. Choosing a subset of frequencies to scan saves time and can be used when the user is interested in scanning only a certain range of frequencies.
3. Enter an amount, in msec, for **Channel listen time**.

Channel listen time is how long Frontline® 802.11 will listen on a channel to discover devices before moving on to the next channel.

4. Select **Yes** or **No** to choose whether to send a probe sync request.

Sometimes an Access Point will intentionally not send its SSID in a beacon to conceal its identity. Selecting **Yes** for this option will send the MAC address, the SSID will be part of the Probe Response it sends back.

5. Select **OK** to save the options and close the dialog or **Cancel** to close the dialog without saving your choices.

3.1.2.6.4 Device Scanner RSSI Values

The 802.11 specification does not provide a relationship between the RSSI value and the actual power value. Here are the definitions from the specification.

1. RSSI in FHSS PHY: The RSSI is an optional parameter that has a value of 0 through RSSI Max. This parameter is a measure by the PHY of the energy observed at the antenna used to receive the current PPDU. RSSI shall be measured between the beginning of the SFD and the end of the PLCP HEC. RSSI is intended to be used in a relative manner. Absolute accuracy of the RSSI reading is not specified.
2. RSSI in DSSS PHY: The RSSI shall be a measure of the RF energy received by the DSSS PHY. RSSI indications of up to 8 bits (256 levels) are supported.
3. RSSI in OFDM PHY: The allowed values for the RSSI parameter are in the range from 0 through RSSI maximum. This parameter is a measure by the PHY of the energy observed at the antenna used to receive the current PPDU. RSSI shall be measured during the reception of the PLCP preamble. RSSI is intended to be used in a relative manner, and it shall be a monotonically increasing function of the received power.

Different vendors implement these value in their own way. The ComProbe 802.11 uses an Atheros chipset which provides RSSI values in the range of 0 to 128. The radio hardware in the ComProbe 802.11 has two receive chains (one for each antenna). Each received packet has RSSI values for both antennas as well as the combined value.

The hardware provides the following five values:

1. rssi_ant00: Receive signal strength indicator of control channel chain 0.
2. rssi_ant01: Receive signal strength indicator of control channel chain 1.
3. rssi_ant10: Receive signal strength indicator of extension channel chain 0.
4. rssi_ant11: Receive signal strength indicator of extension channel chain 1
5. rssi_combined: Receive signal strength indicator of combination of all active chains on the control and extension channels.

All five of these values are shown in the PHY layer decoder for every packet. The Wi-Fi scanner shows the combined value.

3.1.3 Wi-Fi Device - MAC Address Editor

If you know the MAC Address of the device you can enter it manually.

1. From the I/O Settings dialog select the "Edit" button.
2. On the MAC Address Editor enter the MAC Address for the device.

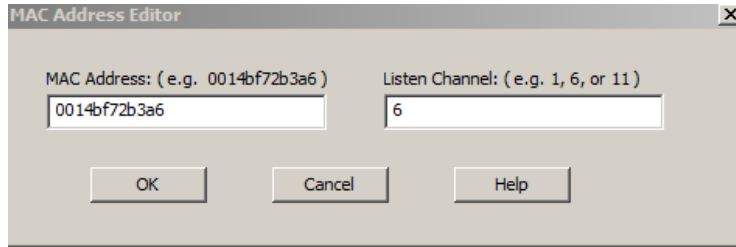

Figure 3.19 - Wi-Fi Direct MAC Address Editor

3. Enter a channel number in Listen Channel.
4. Select "OK".

The MAC Address appears on the I/O Settings dialog.

Once you close the dialog, the last MAC Address shown will appear when you reopen the dialog.

3.2 Decoder Parameters

Some protocol decoders have user-defined parameters. These are protocols where some information cannot be discovered by looking at the data and must be entered by the user in order for the decoder to correctly decode the data. For example, such information might be a field where the length is either 3 or 4 bytes, and which length is being used is a system option.

There may be times when the context for decoding a frame is missing. For example, if the analyzer captures a response frame but does not capture the command frame, then the decode for the response may be incomplete. The **Set Initial Decoder Parameters** window allows you to supply the context for any frame. The dialog allows you to define any number of parameters and save them in a template for later use.

The decoder template function provides the capacity to create multiple templates that contain different parameters. This capability allows you to maintain individual templates for each Bluetooth® network monitored. Applying a template containing only those parameters necessary to decode transmissions particular to an individual network, enhances the efficiency of the analyzer to decode data.

If you have decoders loaded which require decoder parameters, a window with one tab for every decoder that requires parameters appears the first time the decoder is loaded.

For help on setting the parameters, click the **Help** button on each tab to get help information specific to that decoder.

If you need to change the parameters later,

- Choose **Set Initial Decoder Parameters...** from the **Options** menu on the **Control** and **Frame Display** windows.

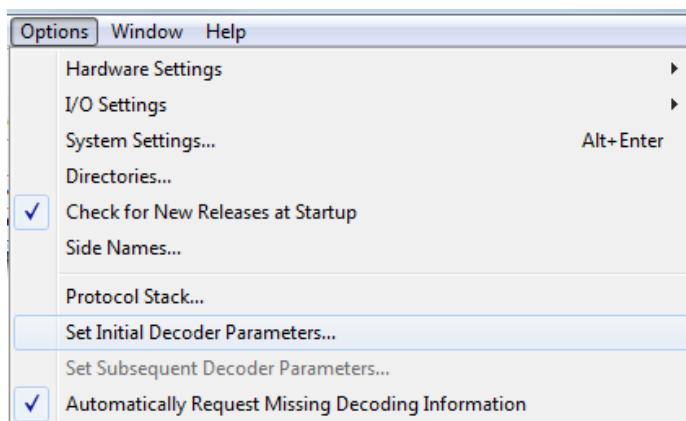

Figure 3.20 - Select **Set Initial Decoder Parameters...** from **Control** window

The **Set Initial Decoder Parameters** window opens with a tab for each decoder that requires parameters.

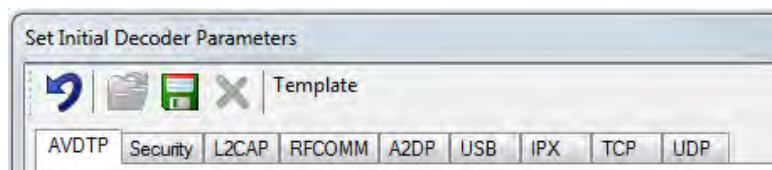

Figure 3.21 - Tabs for each decoder requiring parameters.

- Each entry in the **Set Initial Decoder Parameters** window takes effect from the beginning of the capture onward or until redefined in the **Set Subsequent Decoder Parameters** dialog.

Override Existing Parameters

The **Set Subsequent Decoder Parameters** dialog allows the user to override an existing parameter at any frame in the capture where the parameter is used.

If you have a parameter in effect and wish to change that parameter

- Select the frame where the change should take effect
 - Select **Set Subsequent Decoder Parameters...** from the **Options** menu, and make the needed changes. You can also right-click on the frame to select the same option.

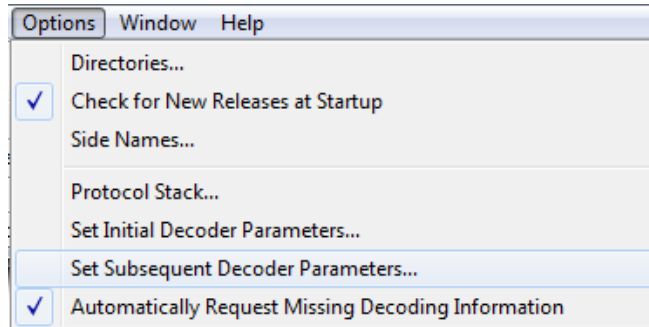

Figure 3.22 - **Set Subsequent Decoder Parameters...** from **Control** window

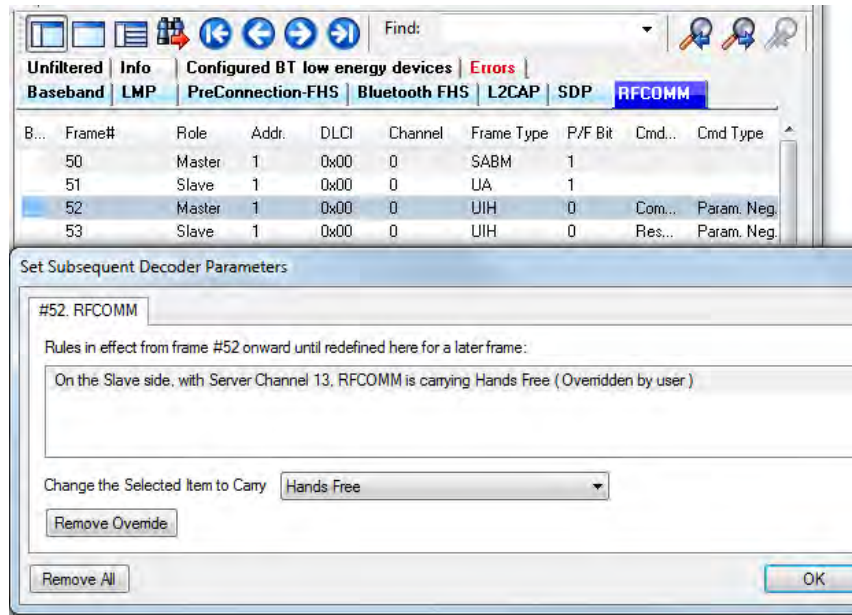





Figure 3.23 - Example: Set Subsequent Decode for Frame #52, RFCOMM

- Each entry in the **Set Subsequent Decoder Parameters** dialog takes effect from the specified frame onward or until redefined in this dialog on a later frame.
- The **Remove Override** button will remove the selected decode parameter override.
- The **Remove All** button will remove all decoder overrides.

If you do not have decoders loaded that require parameters, the menu item does not appear and you don't need to worry about this feature.

3.2.1 Decoder Parameter Templates

3.2.1.1 Select and Apply a Decoder Template

1. Select **Set Initial Decoder Parameters...** from the **Options** menu on the **Control**  window or the **Frame Display**  window.
2. Click the **Open Template**  icon in the toolbar and select the desired template from the pop up list. The system displays the content of the selected template in the Initial Connections list at the top of the dialog
3. Click the OK button to apply the selected template and decoders' settings and exit the **Set Initial Decoder Parameters** dialog.

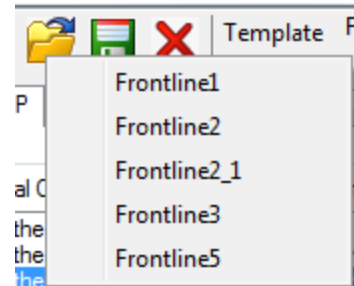

3.2.1.2 Adding a New or Saving an Existing Template

Add a Template

A template is a collection of parameters required to completely decode communications between multiple devices. This procedure adds a template to the system and saves it for later use:

1. Click the **Save**  button at the top of the **Set Initial Decoder Parameters** dialog to display the **Template Manager** dialog.
2. Enter a name for the new template and click **OK**.
The system saves the template and closes the **Template Manager** dialog.
3. Click the **OK** button on the **Set Initial Decoder Parameters** window to apply the template and close the dialog.

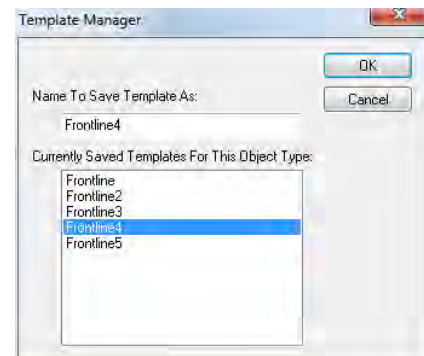

Save Changes to a Template

This procedure saves changes to parameters in an existing template.

1. After making changes to parameter settings in a user defined template, click the **Save**  button at the top of the **Set Initial Decoder Parameters** window to display the **Template Manager** dialog.
2. Ensure that the name of the template is listed in the **Name to Save Template As** text box and click **OK**.
3. The system displays a dialog asking for confirmation of the change to the existing template. Click the **Yes** button.
The system saves the parameter changes to the template and closes the Save As dialog.
4. Click the **OK** button on the **Set Initial Decoder Parameters** window to apply the template and close the window.

3.2.1.3 Deleting a Template

1. After opening the **Set Initial Decoder Parameters** window click the **Delete**  button in the toolbar.
The system displays the **Template Manager** dialog with a list of saved templates.
2. Select (click on and highlight) the template marked for deletion and click the **Delete** button.
The system removes the selected template from the list of saved templates.
3. Click the **OK** button to complete the deletion process and close the Delete dialog.
4. Click the **OK** button on the **Set Initial Decoder Parameters** window to apply the deletion and close the dialog.

3.2.2 Wi-Fi Security Decoder Parameters

On the Set Initial Decoder Parameters dialog, the security tab allows specifying a key for software decryption of 802.11 frames.

To access this dialog:

1. In the **Options** menu on the **Control** window and choose **Set Initial Decoder Parameters**.
2. Select the **Security** tab.

There are three types of types of encrypted data on the security tab, each one selectable via a radio button.

Table 3.3 - WiFi Encrypted Data Options

Option	Description
WPA2	WPA2 (Wi-Fi Protected Access), and WEP (Wired Equivalent Privacy) data that is transmitted over a 802.11 communications link. There are two values you have to enter for the WPA2 and WEP to be decrypted properly.
Bluetooth AMP	The <i>Bluetooth</i> alternative MAC/PHY (AMP) enables <i>Bluetooth</i> to support data rates up to 24 Mbps by using additional wireless radio technologies.
Pre-shared Key	The pre-shared key is a 32-byte hex number.

Depending on which **Encrypted Data** type you select, the options for entering data on the rest of the dialog varies.

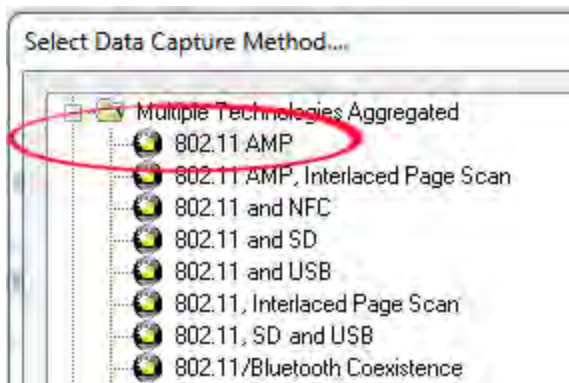

Note: When capturing both *Bluetooth* and 802.11 data using the **802.11AMP** capture method, the ComProbe software uses the link from the BR/EDR connection. To automatically decode 802.11 AMP frames in this case, select the **Bluetooth AMP Encrypted Data**, but leave the **Link Key** field blank.

Table 3.4 - WiFi Encrypted Data Option Fields

Encrypted Data Option	Field	Description
WPA2	WPA2: SSID	The station ID of the 802.11 communications link.
	WEP: SSID	The station ID of the 802.11 communications link.
	WEP: Passkey	The shared passkey phrase used in communications.
Bluetooth AMP	BDR/EDR Link Key	A hexadecimal value for the BR/EDR Link Key . (See note See Note on the previous page).
	WEP: SSID	The station ID of the 802.11 communications link.
	WEP: Passkey	The shared passkey phrase used in communications.
Pre-Shared Key	Raw Hex Key	Enter a 32-byte hex number
	WEP: SSID	The station ID of the 802.11 communications link.
	WEP: Passkey	The shared passkey phrase used in communications.

The screenshot shows a configuration window with the following elements:

- Navigation tabs: AVDTP, Security, L2CAP, RFCOMM, A2DP, USB, IPX, TCP, UDP.
- Section: Encrypted Data
- Radio buttons:
 - WPA2
 - Bluetooth AMP
 - Pre-Shared Key
- WPA2 configuration:
 - SSID: [Text Input Field]
 - Passkey: [Text Input Field]
- Bluetooth AMP configuration:
 - BR/EDR Link Key: [Text Input Field]
- Pre-Shared Key configuration:
 - Raw Hex Key: [Text Input Field]
- WEP configuration:
 - SSID: [Text Input Field]
 - Passkey: [Text Input Field]

Figure 3.24 - Decoder WiFi Security Tab

3.2.3 Adding or Changing TCP/UDP Port Assignments

TCP and UDP are Transport layer protocols in the IP protocol suite. These transport layer protocols use ports to establish communication between application layer protocols. For example, all Web traffic uses the HTTP protocol. HTTP is an application layer protocol that uses the standard TCP/UDP port 80. The Internet Assigned Numbers Authority (IANA) is responsible for maintaining the list of standard port numbers and their assignments. For an up-to-date listing of all standard TCP/UDP port assignments, visit www.iana.org.

When the analyzer reads a TCP, UDP or IPX packet, it infers the upper layer protocols by using pre-defined rules of traversal. For example, if the packet has a TCP source or destination port number 80, then the upper layer protocol is HTTP. These rules, which are built in to the software, determine the upper layers of the protocol stack based on the source or destination port numbers in the packet. The built-in rules are based on the standard port assignments. However, it is quite common to come across network systems in which upper layer protocols use user-defined port numbers for both standard and custom protocols. In such cases, the analyzer users can tell the software which port numbers are assigned to which protocols.

The analyzer autotraverses the stack from TCP, UDP and IPX based on the source or destination port number. Many systems use user-defined port numbers for both standard and custom protocols. Here's how to tell the analyzer about a custom port assignment on the system you are monitoring.

Add a New Port Assignment

1. Choose Set Initial Decoder Parameters from the Options menu on the Control  window.
2. Click the TCP tab (or UDP or IPX for those protocols).
3. Choose the Single Port radio button
4. Enter the port number in the Port Number box.
5. In the Protocol drop-down list, choose the protocol to traverse to.
6. Click the Add button.

The system adds the new entry to the bottom of the port number list.

Modify an Existing Port Assignment

1. Choose **Set Initial Decoder Parameters** from the **Options** menu on the Control window.
2. Click the **TCP** tab (or **UDP** or **IPX** for those protocols).
3. Select (click on and highlight) the port assignment to modify.
4. Change the port number and/or choose the protocol to traverse to.
5. Select the **Port Range** radio button and specify the starting and ending port numbers. The range is inclusive.
6. Click the **Modify** button.

The system displays the changes in port assignment.

Delete a Port Assignment

1. Choose **Set Initial Decoder Parameters** from the **Options** menu on the Control window.
2. Click the **TCP** tab (or **UDP** or **IPX** for those protocols).
3. Select (click on and highlight) the port assignment to delete.
4. Select **Delete**.

The system deletes the port assignment.

Move a Port Assignment

If you need to move an entry to ensure it is processed before or after another entry, select the entry in the list and then click the **Move Up** or **Move Down** buttons.

Port Assignment Considerations

- The analyzer traverses an entry if either the source or destination port match.
- The analyzer processes port number entries in order from top to bottom.

3.2.4 Determining Master and Slave

In *Bluetooth*, the device that initiates the connection is always the master at connection time. You only need to know the master and slave at connection time when setting up the I/O Settings. Afterward a role switch may occur, but the analyzer automatically follows the role switch.

Note: You do not have to identify a Master address if you are using Firmware Version 62 or newer.

Role Switches

After the connection has been made, a role switch can take place. A good example of why this happens would be when a mouse connects to the PC. The mouse initiates the connection, so it is the master. After the connection is made, a role switch occurs so that the PC becomes the master and the mouse becomes a slave. The role switch takes place because the PC may be working with multiple devices at the same time, and as such, the PC would not be a slave of more than one device.

Let us say that a link exists between a PC and a keyboard with the PC a master. If the mouse wants to become a member of the link it initiates the connection. Since the mouse initiated the connection, it is the master of a new link and the PC is the slave. The PC is still the master of the link between the PC and keyboard. A role switch now occurs between the PC and the mouse, and the PC is now the master of a link with two slaves: the mouse and keyboard.

3.3 Conductive Testing

Conductive testing could be used for many reasons, but the most common use is to isolate the Wi-Fi test setup from the surrounding environment. Interference from radio frequency (RF) sources is the most common reason for isolating the test from the environment. This is especially important when the environment contains RF sources using the industrial, scientific, and medical (ISM) radio bands from 2.4 to 2.485 GHz that are the bands used for Wi-Fi.

“Conductive” in this context means that you are not “air sniffing”, that is, capturing Wi-Fi transmissions on the Frontline analyzer's antenna. The conductive test setup uses coaxial cable to directly connect the Device Under

Test (DUT) to the analyzer's antenna connectors. The coaxial cable provides the isolation from the environment through shielding.

3.3.1 802.11 WiFi Conductive Testing

“Conductive” in this context means that you are not “air sniffing”, that is, capturing 802.11 transmissions on the ComProbe 802,11 analyzer antenna. The conductive test setup uses coaxial cable to directly connect the DUT (Device Under Test) to the analyzer antenna connectors. The coaxial cable provides the isolation from the environment through shielding.

Test Equipment

The following equipment is required for the test setup. All cables, connectors and adapters, and attenuators should be relatively flat from 2 GHz to 6 GHz.

1. Coaxial cable All cable must be 50Ω and should be double shielded.
2. Coaxial T-connectors, 50Ω.
3. RP.SMA adapters for connecting coaxial cable or attenuators to the antenna connectors, 50Ω.
4. AT1 - AT9: 20 dB attenuators, 50Ω.
5. Frontline 802.11 WiFi protocol analyzer.
6. Computer for running Frontline software.

Test Setup

[Figure 3.25 below](#) shows the 802,11 conductive test setup.

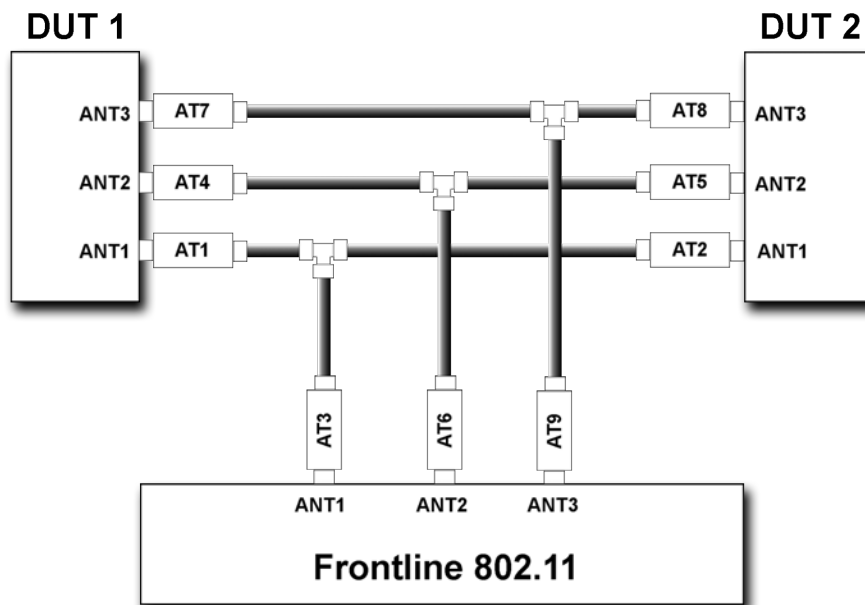

Figure 3.25 - Frontline 802.11 Conductive Test Setup for 3X3 MIMO

The above test setup is for 3X3 MIMO 802.11 devices. If not testing this configuration, the ANT3 connection to the DUTs and the ComProbe 802.11 is not used.

Test Process

After connecting DUT1, DUT2, and the Frontline 802.11, follow these steps to capture WiFi data.

1. Establish data transmission between DUT 1 and DUT 2.
2. Begin capture of the data with the Frontline 802.11 .
3. Conduct protocol analysis with the Frontline software on the personal computer or save the capture file for future analysis.

Chapter 4 Capturing and Analyzing Data

The following sections describe the various ComProbe software functions that capture and display data packets.

4.1 Capture Data

4.1.1 Air Sniffing: Positioning Devices

When capturing over the air packets, proper positioning of the Frontline hardware and the Devices Under Test (DUTs) will result in the best possible captures and will mitigate sources of path loss and interference. The following procedures will help optimize the capture process especially if you are have problems obtaining reliable ...captures.

Problems with indoor radio propagation

Even in free space, it is well understood that radio frequencies attenuate over distance. The free-space rule-of-thumb dictates that radio energy decreases in strength by 20 dB by each 10-to-1 increase in range. In the real-world, the effects of objects in an outdoor environment cause reflection, diffraction, and scattering resulting in greater signal losses. Indoors the situation can be worse. Reflections occur from walls and other large flat surfaces. Diffraction occurs from objects with sharp edges. Scattering is produced from objects with rough surfaces and from small objects. Also any object directly in the path of the radiation can present a hard or soft partition depending on the partition's material properties. Path losses from partitions are difficult to estimate.

Estimating indoor propagation loss

One estimate of indoor path loss, based on path loss data from a typical building, provides a $\frac{1}{range^{3.5}}$ power rule. At 2.4 GHz, the following relationship provides an approximate estimate of indoor path loss:

$$\text{Indoor Path Loss (in dB)} = 40 + 35 \text{Log}_{10}(\text{range, in meters})$$

This approximation is expected to have a variance of 13 dB.

Mitigating path loss and interference

Bluetooth device design contributes to mitigating environmental effects on propagation through spread spectrum radio design, for example. However, careful planning of the testing environment can also contribute to reliable data capture process.

The first step to ensuring reliable air-sniffing data capture is to understand the RF characteristics of the Devices Under Test (DUTs). The *Bluetooth* Class, antenna types, and radiation patterns are all important factors that can affect the placement of the DUTs and the Frontline hardware. Radiation patterns are rarely spherical, so understanding your device's radiation patterns can greatly enhance successful data capture. Position devices to avoid radiation attenuation by the surroundings.

This step is optional: Consider conductive testing to establish a baseline capture. Conductive testing isolates the DUTs and analyzer from environmental effects.

The next step is to ensure that the testing environment is as clutter-free as possible.

- Line-of-sight obstructions should be eliminated between the Frontline hardware and the DUTs because they cause a reduction in signal strength. Obstructions include, but are not limited to: water bottles, coffee cups, computers, computer screens, computer speakers, and books. A clear, unobstructed line-of-sight is preferred for DUT and Frontline hardware positioning.
- If using an analyzer connected to a computer, position the computer on an adjacent table or surface away from the analyzer and DUTs, taking advantage of the cables' length. If this is not possible, position the computer behind the analyzer as far away as possible. If using the Frontline FTS4BT, which is a dongle, either use an extension USB cable or position the computer such that the dongle is positioned towards the DUTs.
- The preferred placement is positioning the DUTs and the Frontline hardware at the points of an equilateral triangle in the same horizontal plane, i.e. placed on the same table or work surface. The sides of the triangle should be between 1 and 2 meters for *Bluetooth* transmitter classes 1 and 2. The distance for transmitter class 3 should be 1/2 meter.



Figure 4.1 - Devices Equally Spaced in the Same Horizontal Plane

Finally, eliminate other RF sources.

- Wi-Fi interference should be minimized or eliminated. *Bluetooth* shares the same 2.4 GHz frequency bands as Wi-Fi technology. Wi-Fi interference can cause loss of packets and poor captures. In a laboratory or testing

environment do not place the DUTs and Frontline hardware in close proximity with Wi-Fi transmitting sources such as laptops or routers. Turning off Wi-Fi on the computer running the Frontline software is recommended.

Poor Placement

A poor test configuration for the analyzer is placing the DUTs very close to each other and the analyzer far away. The DUTs, being in close proximity to each other, reduce their transmission power and thus make it hard for the analyzer to hear the conversation. If the analyzer is far away from DUTs, there are chances that the analyzer may miss those frames, which could lead to failure in decryption of the data.

Obstacles in close proximity to or in between the analyzer and the DUTs can interfere and cause reduction in signal strength or interference. Even small objects can cause signal scattering.

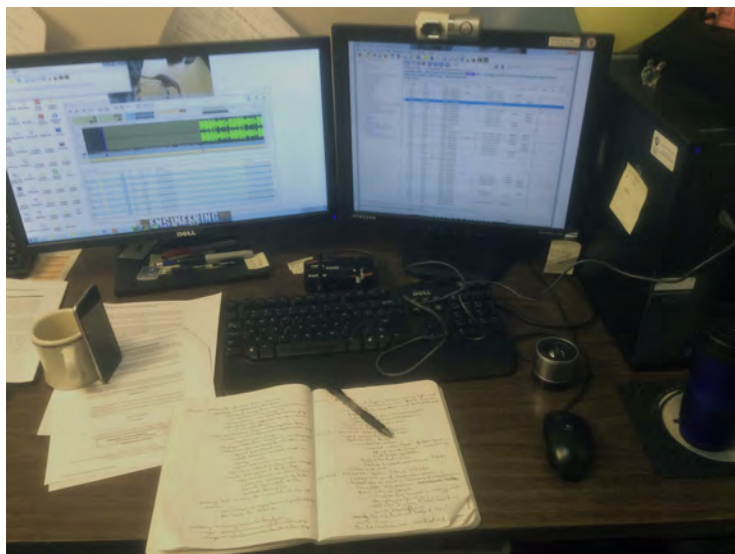





Figure 4.2 - Example: Poor Capture Environment

4.1.2 Capturing Data to Disk - General Procedure

Note: Capture is not available in Viewer mode.

1. Click the **Start Capture** button  to begin capturing to a file. This icon is located on the **Control**, **Event Display**, and **Frame Display** windows.
2. Files are placed in My Capture Files by default and have a .cfa extension. Choose **Directories** from the **Options** menu on the **Control** window to change the default file location.

Note: For the Dashboard, when you capture to series of files, the window displays the data from the beginning of the first capture, even when a new file in the series is created. This is because the Dashboard is a "Session Monitor", which means that even if you capture to a series of files, the data from the first file is always displayed. The display does not refresh when a new capture file in a series is created.

3. Watch the status bar on the **Control** window to monitor how full the file is. When the file is full, it begins to wrap, which means the oldest data will be overwritten by new data.
4. Click the **Stop Capture** icon  to temporarily stop data capture. Click the **Start Capture** icon again to resume capture. Stopping capture means no data will be added to the capture file until capture is resumed, but the previously captured data remains in the file.
5. To clear captured data, click the **Clear** icon .
 - If you select **Clear** after selecting **Stop Capture**, a dialog appears asking whether you want to save the data.
 - You can click **Save File** and enter a file name when prompted .
 - If you choose **Do Not Save**, all data will be cleared.
 - If you choose **Cancel**, the dialog closes with no changes.
 - If you select the **Clear** icon while a capture is occurring:
 - The capture stops.
 - A dialog appears asking if you want to save the capture
 - You can select **Yes** and save the capture or select **No** and close the dialog. In either case, the existing capture file is cleared and a new capture file is started.
 - If you choose **Cancel**, the dialog closes with no changes.

To see how to capture to a single file, choose [System Settings](#) from the Options menu on the Control window.

When live capture stops, no new packets are sniffed but there can still be packets that were previously sniffed but not yet read by the ComProbe analyzer. This happens when packets are being sniffed faster than the ComProbe analyzer can process them. These packets are stored either on the ComProbe hardware itself or in a file on the PC. If there are remaining packets to be processed when live capture stops the **Transferring Packets** dialog below is displayed showing the packets yet to be read by the ComProbe analyzer. The dialog shows the name of each ComProbe hardware device, its process id in square brackets, and the number of packets remaining. These stored packets are read until they're exhausted or the user clicks the Discard button on the dialog.

Unlike 802.11, *Bluetooth* packets never come in faster than the datasource can process them. However, *Bluetooth* packets must still be stored so that they can be read in chronological order with the 802.11 packets.

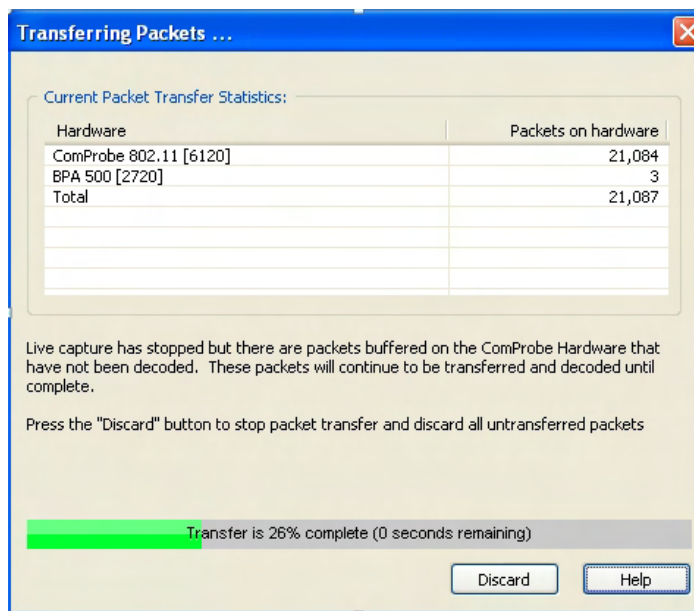



Figure 4.3 - Packet Transfer Dialog

4.1.2.1 Frontline® 802.11 with Wireshark®

4.1.3 Capturing Using Frontline Wi-Fi Datasource with Wireshark®

Note: This topic is provided as a courtesy to our customers who want to use Wireshark in conjunction with the ComProbe 802.11 although the ComProbe software is fully capable of performing the same functions as Wireshark. Frontline does not support or maintain third party products. Should you have difficulty with your Wireshark product contact the manufacturer for support or maintenance.

Click on the "ComProbe 802.11 with Wireshark" short cut to launch and start capturing the Wi-Fi packets. If you do not see any packets on the Wireshark window then check the status message indication on the **Wi-Fi Datasource** window to see if sniffing has stopped. Click on the **Start**  button .

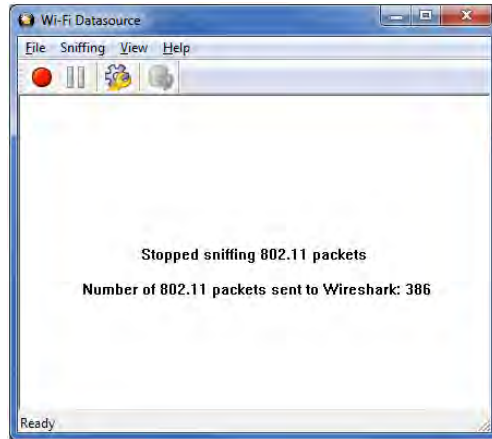



Figure 4.4 - Datasource Stopped Sniffing

When the ComProbe 802.11 is sniffing the datasource will display the following message. Sniffing can be stopped by clicking the **Stop** button  .

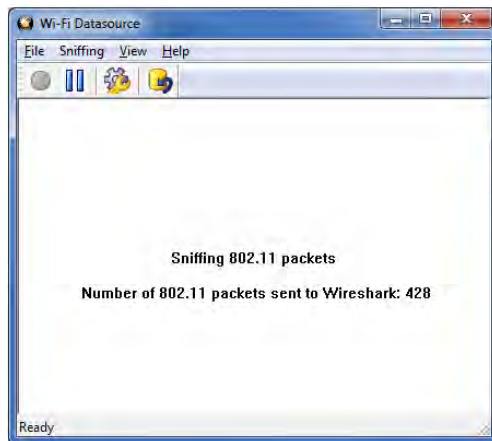

Figure 4.5 - Datasource Sniffing

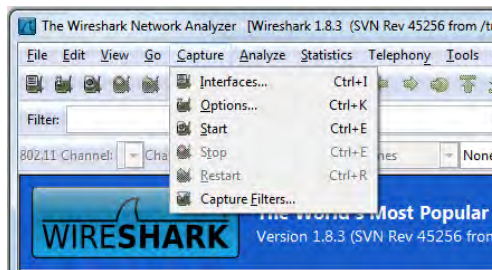



Figure 4.6 - Wireshark Capture Dialog

Note: Whenever you give Start Capture command on Wireshark, the status message on the Wi-Fi Datasource window should display "Please START capturing on the Wireshark." If it is displaying a different message then you can use the Reset button on the Wi-Fi Datasource window or select **Reset**  or in the Sniffing menu to get back to this message.

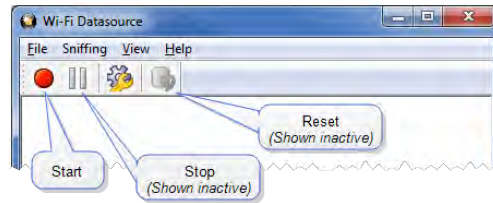

Figure 4.7 - Wi-Fi Datasource Toolbar

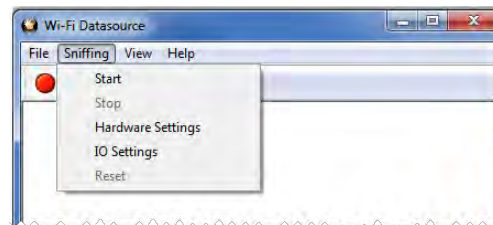





Figure 4.8 - Wi-Fi Datasource Sniffing Menu

Once the Wi-Fi Datasource starts capturing packets and sending them to Wireshark, you can pause and resume capturing using the **Stop**  and **Start**  toolbar buttons on the Wi-Fi Datasource toolbar or the **Sniffing** menu. Note that the **Restart** command on the Wireshark window does not function. The workaround is to click **Reset**  on the Wi-Fi Datasource then click **Start** on the Wireshark Capture menu. Also the Wireshark Capture Filters menu does not function, but you can use IO Settings menu on the Wi-Fi Datasource window or **Sniffing** menu for setting filters.

Known Issues with Wireshark

- In Real Time capture mode (when you select Update list of packets in real time check-box in the Capture Options dialog), if you move the Wireshark window around on the desktop or click on anything on the Wireshark window, it freezes the desktop. You can unfreeze it by bringing up Windows Task Manager by pressing Ctrl+Alt+Delete.

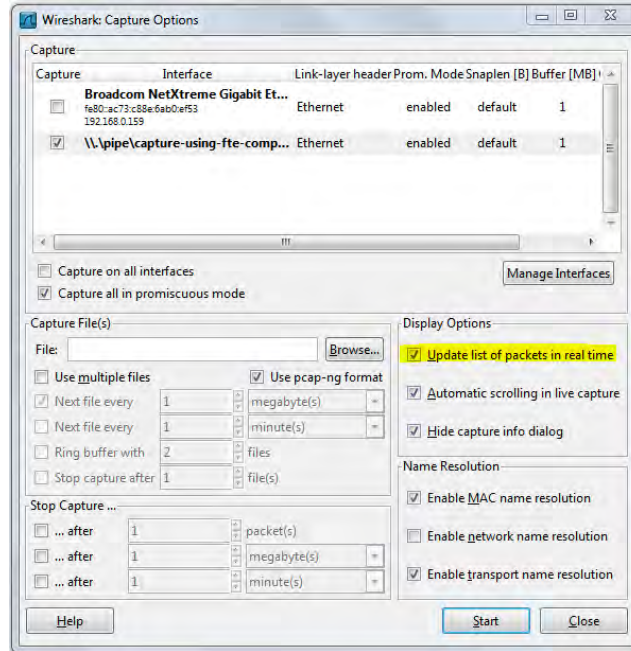

Figure 4.9 - Wireshark Capture Options

- If you capture more than a few millions of packets, e.g. 4 million, Wireshark crashes.

4.1.4 Combining BPA 600, 802.11, and HSU with ProbeSync

ProbeSync™ allows multiple ComProbe analyzers to work seamlessly together and to share a common clock. Clock sharing allows the analyzers to precisely synchronize communications stream and to display resulting packets in a single shared view.

The ComProbe BPA 600, ComProbe 802.11, and ComProbe HSU analyzers have ProbeSync capability allowing timestamp synchronization of captured data. Synchronizing the clock for these ComProbe devices used in combination requires attention to the sequence of hardware connection. It is important to remember the following key points.

- ComProbe devices are connected serially in a daisy-chain fashion. The combined length of all cables in the chain cannot exceed 1.5 meters (4.5 ft.).
- The "master" ComProbe device provides the clock to the other devices. All other ComProbe devices are "slaves" and received the clock from the "master" device.
- On ComProbe devices with an **OUT** and **IN** connector, the function of these connectors is dependent on if they are a "master" or a "slave".
 - "master" device: **OUT** connector provides the clock to all "slave" devices. **IN** connector is not used.
 - "slave" device: **IN** connector receives the clock from the **OUT** connector of the prior device in the chain. The **OUT** connector is just a pass-through connector on a "slave" device.
- BPA 600 is always the "master" device and the first device in the chain, if being used.
- HSU is always the last "slave" device in the chain, if being used.
- HSU maximum capture data rate is 6 Mbit/sec.

Connecting ComProbe BPA 600, ComProbe 802.11, and ComProbe HSU devices in ProbeSync takes place in the following steps.

1. Connect the ComProbe BPA 600 **OUT** connector to the ComProbe 802.11 **IN** connector.
2. Connect the ComProbe HSU Cat 5 cable to the ComProbe 802.11 **OUT** connector.

Each device datasource is setup individually to sniff their respective link. That is, you will see a separate datasource window for the BPA 600 device, the 802.11 device, and the HSU device.

Data saved as a capture file will include data captured on each device.

Should the hardware be connected incorrectly, that is **IN** to **IN** or **OUT** to **OUT**, an error message will appear. Follow the instructions in error message. To continue click on the **OK** button. The ComProbe device datasource **Status** window will also display a warning message suggesting information sources.

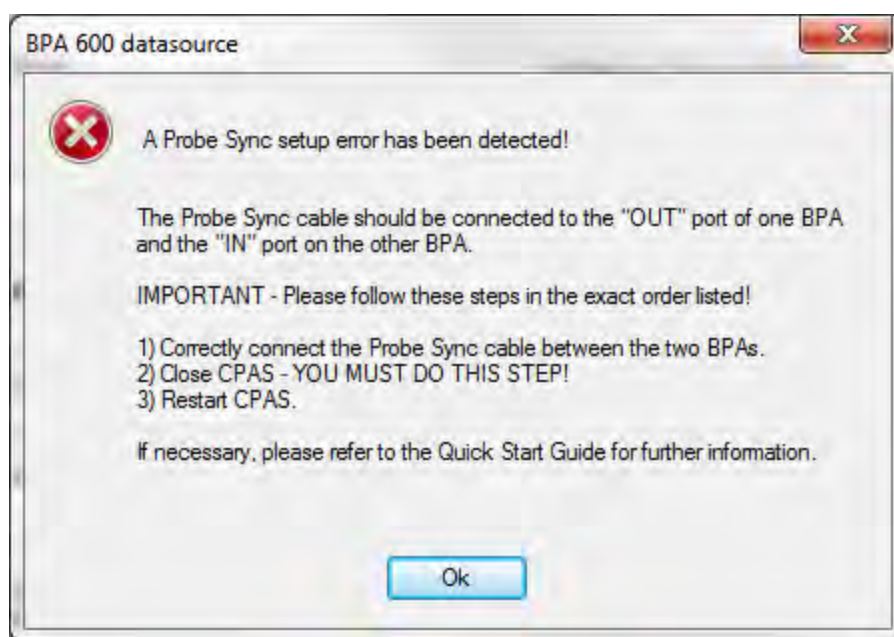

Figure 4.10 - Incorrect ProbeSync Hardware Connection Error

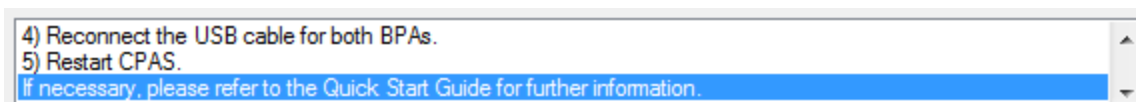



Figure 4.11 - Incorrect ProbeSync Hardware Connection Message In Datasource Status

The **BPA 600 datasource** dialog **Start Sniffing**  button initiates the capture for all connected ComProbe 802.11 and HSU devices. On the 802.11 and HSU receiving the clock—cable connected to **IN**— the **Start Sniffing** button is disabled when using ProbeSync. In each ComProbe device's **Control** window status window will announce the synchronizing function.

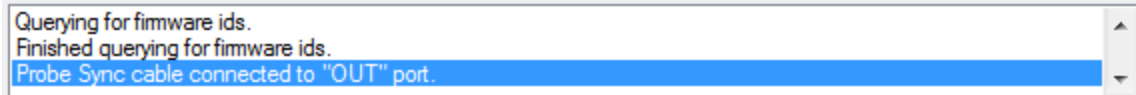

Figure 4.12 - ProbeSync Synchronizing Device Status Message

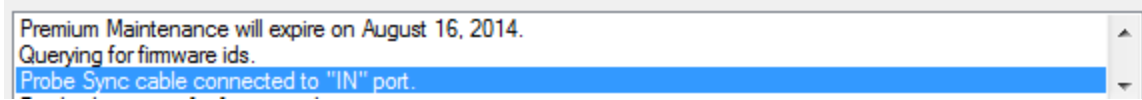

Figure 4.13 - ProbeSync Synchronized Device Status Message

Data captured in the synchronized device will appear in the **Frame Display, Event Display, Bluetooth Timeline, Bluetooth low energy Timeline, and Coexistence View.**

4.1.5 Sodera & 802.11: Capturing with ProbeSync

ProbeSync allows Frontline Sodera and 802.11 hardware to work seamlessly together and to share a common clock. Clock sharing allows the analyzers to precisely synchronize communications streams and to display resulting packets in a single shared view.

When configured for synchronization through ProbeSync, one Sodera device provides the clock to the other device. The clock is provided by a provided CAT 5 cable between the master Sodera **PROBESYNC OUT** connector—sending the synchronizing clock—to the slave device hardware ProbeSync **IN** connector—receiving the clock.

When the Frontline software runs in ProbeSync mode, only the Sodera Control window and Sodera datasource window will appear. Should the hardware be connected incorrectly, that is **IN to IN** or **OUT to OUT**, an error message will appear in the Event Log pane.

Event Log	
Description	Time
ComProbe Protocol Analysis Software Version: 16.4.10179.10266	5/4/2016 9:13:23.267 AM
Connected to ComProbe Sodera SN: A1604-00005 Hardware Version: F0 00 Firmware Version: 201511060720	5/4/2016 9:13:23.875 AM
Premium Maintenance will expire on March 11, 2017.	5/4/2016 9:13:23.875 AM
ProbeSync Cable not properly connected.	5/4/2016 9:13:25.123 AM

Figure 4.14 - Incorrect ProbeSync Hardware Connection Message

The Sodera datasource window **Record** button initiates the capture for both devices.

Data captured in the synchronized device will appear in the **Frame Display, Event Display, Bluetooth Timeline, Bluetooth low energy Timeline, and Coexistence View.** Data saved as a capture file during analysis will include data captured on both devices.

4.1.6 Extended Inquiry Response

Extended Inquiry Response (EIR) is a tab that appears automatically on the **Frame Display** window when you capture data.

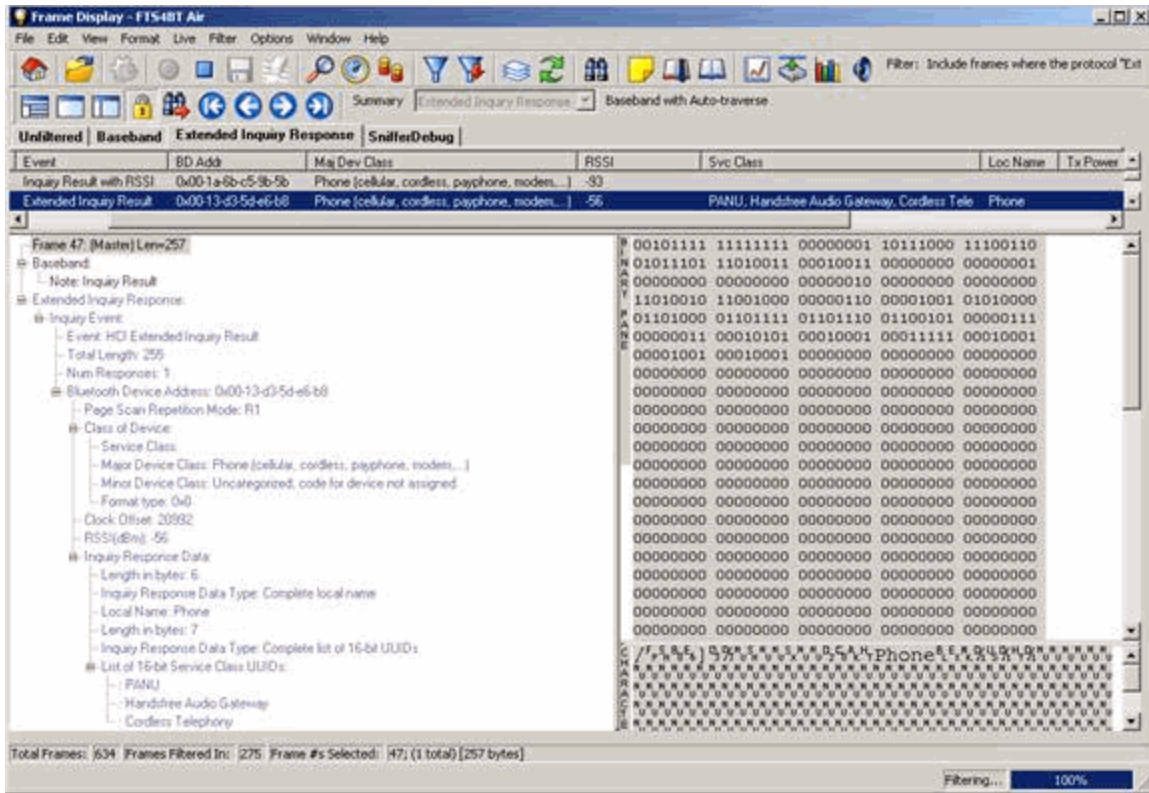

Figure 4.15 - Frame Display Extended Inquire Response

EIR displays extensive information about the Bluetooth® devices that are discovered as data is being captured. EIR provides more information during the inquiry procedure to allow better filtering of devices before connection; and sniff subrating, which reduces the power consumption in low-power mode. Before the EIR tab was created, this type of information was not available until a connection was made to a device. Therefore, EIR can be used to determine whether a connection can/should be made to a device prior to making the connection.

Note: If a *Bluetooth* device does not support **Extended Inquiry Response**, the tab displays **Received Signal Strength Indication (RSSI)** data, which is less extensive than EIR data.

4.2 Protocol Stacks

4.2.1 Protocol Stack Wizard

The Protocol Stack wizard is where you define the protocol stack you want the analyzer to use when decoding frames.

To start the wizard:

1. Choose **Protocol Stack** from the **Options** menu on the **Control** window or click the **Protocol Stack** icon  on the **Frame Display**.
2. Select a protocol stack from the list, and click **Finish**.

Most stacks are pre-defined here. If you have special requirements and need to set up a custom stack, see [Creating and Removing a Custom Stack on page 59](#).

1. If you select a custom stack (i.e. one that was defined by a user and not included with the analyzer), the **Remove Selected Item From List** button becomes active.
2. Click the **Remove Selected Item From List** button to remove the stack from the list. You cannot remove stacks provided with the analyzer. If you remove a custom stack, you need to define it again in order to get it back.

If you are changing the protocol stack for a capture file, you may need to reframe. See [Reframing on page 60](#) for more information.

You cannot select a stack or change an existing one for a capture file loaded into the Capture File Viewer (the Capture File Viewer is used only for viewing capture files and cannot capture data). Protocol Stack changes can only be made from a live session.

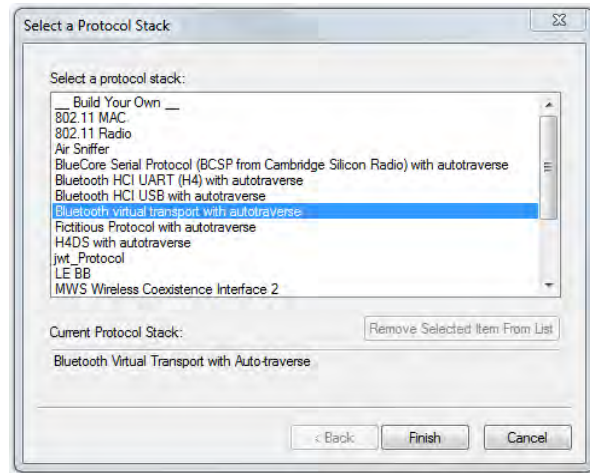

4.2.2 Creating and Removing a Custom Stack

To create a custom stack:

1. Choose **Protocol Stack** from the **Options** menu on the **Control** window or click the Protocol Stack icon  on the **Frame Display** toolbar.
2. Select **Build Your Own** from the list and click **Next**.
3. The system displays an information screen that may help you decide if you need to define your own custom stack. Defining a custom stack means that the analyzer uses the stack for every frame. Frames that do not conform to the stack are decoded incorrectly. Click **Next** to continue.

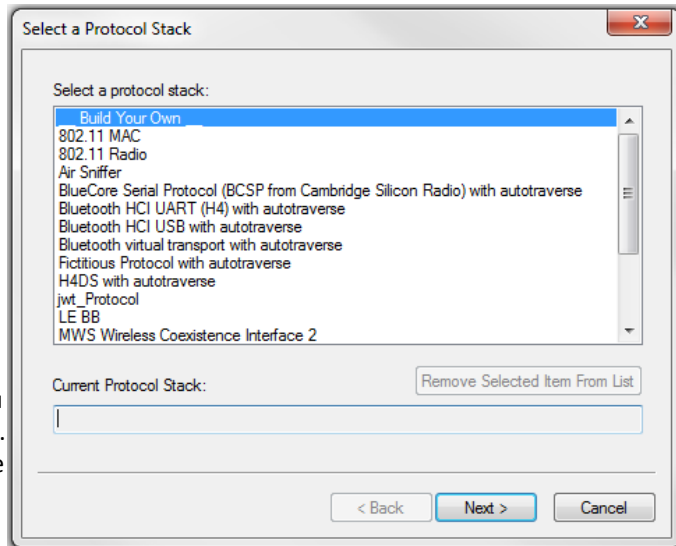

Select Protocols

1. Select a protocol from the list on the left.
2. Click the right arrow button to move it to the **Protocol Decode Stack** box on the right, or double-click the protocol to move it to the right.
3. To remove a protocol from the stack, double-click it or select it and click the left arrow button.
4. If you need to change the order of the protocols in the stack, select the protocol you want to move, and click on the **Move Up** and **Move Down** buttons until the protocol is in the correct position.
5. The lowest layer protocol is at the top of the list, with higher layer protocols listed underneath.

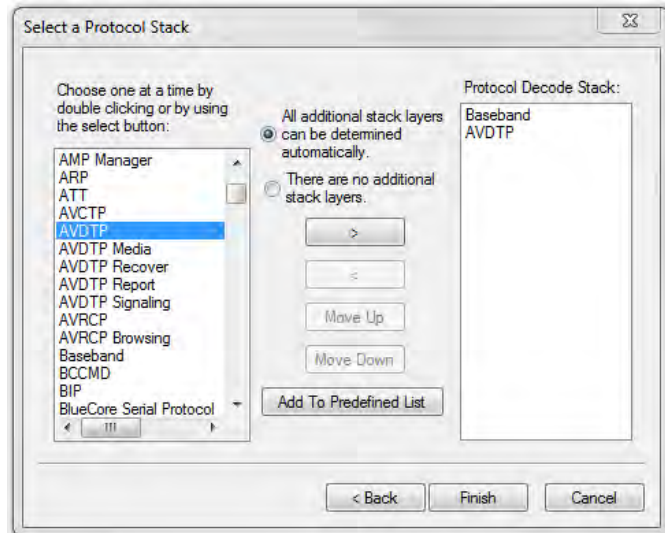

Auto-traversal (Have the analyzer Determine Higher Layers)

If you need to define just a few layers of the protocol stack, and the remaining layers can be determined based on the lower layers:

1. Click the **All additional stack layers can be determined automatically** button.
2. If your protocol stack is complete and there are no additional layers, click the **There are no additional stack layers** button.

3. If you select this option, the analyzer uses the stack you defined for every frame. Frames that do use this stack are decoded incorrectly.

Save the Stack

1. Click the Add To Predefined List button.
2. Give the stack a name, and click Add.

In the future, the stack appears in the **Protocol Stack List** on the first screen of the Protocol Stack wizard.

Remove a Stack

1. Select it in the first screen and click Remove Selected Item From List.
2. If you remove the stack, you must to recreate it if you need to use it again.

Note: If you do not save your custom stack, it does appear in the predefined list, but applies to the frames in the current session. However, it is discarded at the end of the session.

4.2.3 Reframing

If you need to change the protocol stack used to interpret a capture file and the framing is different in the new stack, you need to reframe in order for the protocol decode to be correct. You can also use **Reframe** to frame unframed data. The original capture file is not altered during this process.

Note: You cannot reframe from the Capture File Viewer .

To reframe your data, load your capture file, select a protocol stack, and then select **Reframe** from the **File** menu on the **Control** window. **Reframe** is only available if the frame recognizer used to capture the data is different from the current frame recognizer.

In addition to choosing to **Reframe**, you can also be prompted to Reframe by the Protocol Stack Wizard.

1. Load your capture file by choosing **Open** from the **File** menu on the **Control** window, and select the file to load.
2. Select the protocol stack by choosing **Protocol Stack** from the **Options** menu on the **Control** window, select the desired stack and click **Finish**.
3. If you selected a protocol stack that includes a frame recognizer different from the one used to capture your data, the **Protocol Stack Wizard** asks you if you want to reframe your data. Choose **Yes**.
4. The analyzer adds frame markers to your data, puts the framed data into a new file, and opens the new file. The original capture file is not altered.

See [Unframing on page 60](#) for instructions on removing framing from data.

4.2.4 Unframing

This function removes start-of-frame and end-of-frame markers from your data. The original capture file is not altered during this process. You cannot unframe from the Capture File Viewer (accessed by selecting Capture File

Viewer or Load Capture File to start the software and used only for viewing capture files).

To manually unframe your data:

1. Select **Unframe** from the **File** menu on the **Control** window. **Unframe** is only available if a protocol stack was used to capture the data and there is currently no protocol stack selected.

In addition to choosing to **Unframe**, you can also be prompted to Unframe by the Protocol Stack Wizard.

1. Load your capture file by choosing **Open** from the **File** menu on the **Control** window.
2. Select the file to load.
3. Choose **Protocol Stack** from the **Options** menu on the **Control** window
4. Select **None** from the list
5. Click **Finish**. The Protocol Stack Wizard asks you if you want to unframe your data and put it into a new file.
6. Choose **Yes**.

The system removes the frame markers from your data, puts the unframed data into a new file, and opens the new file. The original capture file is not altered.

See [Reframing on page 60](#) for instructions on framing unframed data.

4.2.5 How the Analyzer Auto-traverses the Protocol Stack

In the course of doing service discovery, devices ask for and receive a Protocol Descriptor List defining which protocol stacks the device supports. It also includes information on which PSM to use in L2CAP, or the channel number for RFCOMM, or the port number for TCP or UDP. The description below talks about how the analyzer auto-traverses from L2CAP using a dynamically assigned PSM, but the principle is the same for RFCOMM channel numbers and TCP/UDP port numbers.

The analyzer looks for SDP Service Attribute Responses or Service Search Attribute Responses carrying protocol descriptor lists. If the analyzer sees L2CAP listed with a PSM, it stores the PSM and the UUID for the next protocol in the list.

After the SDP session is over, the analyzer looks at the PSM in the L2CAP Connect frames that follow. If the PSM matches one the analyzer has stored, the analyzer stores the source channel ID and destination channel ID, and associates those channel IDs with the PSM and UUID for the next protocol. Thereafter, when the analyzer sees L2CAP frames using those channel IDs, it can look them up in its table and know what the next protocol is.

In order for the analyzer to be able to auto-traverse using a dynamically assigned PSM, it has to have seen the SDP session giving the Protocol Descriptor Lists, and the subsequent L2CAP connection using the PSM and identifying the source and channel IDs. If the analyzer misses any of this process, it is not able to auto-traverse. It stops decoding at the L2CAP layer.

For L2CAP frames carrying a known PSM (0x0001 for SDP, for example, or 0x0003 for RFCOMM), the analyzer looks for Connect frames and stores the PSM along with the associated source and destination channel IDs. In this case the analyzer does not need to see the SDP process, but does need to see the L2CAP connection process, giving the source and destination channel IDs.

4.2.6 Providing Context For Decoding When Frame Information Is Missing

There may be times when you need to provide information to the analyzer because the context for decoding a frame is missing. For example, if the analyzer captured a response frame, but did not capture the command frame indicating the command.

The analyzer provides a way for you to supply the context for any frame, provided the decoder supports it. (The decoder writer has to include support for this feature in the decoder, so not all decoders support it. Note that not all decoders require this feature.)

If the decoder supports user-provided context, three items are active on the **Options** menu of the **Control** window and the **Frame Display** window. These items are **Set Initial Decoder Parameters**, **Automatically Request Missing Decoding Information**, and **Set Subsequent Decoder Parameters**. (These items are not present if no decoder is loaded that supports this feature.)

Set Initial Decoder Parameters is used to provide required information to decoders that is not context dependent but instead tends to be system options for the protocol.

Choose **Set Initial Decoder Parameters** in order to provide initial context to the analyzer for a decoder. A dialog appears that shows the data for which you can provide information.

If you need to change this information for a particular frame :

1. Right-click on the frame in the Frame Display window
2. Choose Provide <context name>.

Alternatively, you can choose **Set Subsequent Decoder Parameter** from the **Options** menu.

3. This option brings up a dialog showing all the places where context data was overridden.
4. If you know that information is missing, you can't provide it, and you don't want to see dialogs asking for it, un-check **Automatically Request Missing Decoding Information**.
5. When unchecked, the analyzer doesn't bother you with dialogs asking for frame information that you don't have. In this situation, the analyzer decodes each frame until it cannot go further and then simply stop decoding.

4.3 Analyzing Protocol Decodes

4.3.1 The Frame Display

To open this window

Click the **Frame Display** icon  on the **Control** window toolbar, or select **Frame Display** from the **View** menu.

Frame Display Panes

The **Frame Display** window is used to view all frame related information. It is composed of a number of different sections or "panes", where each pane shows a different type of information about a frame.

- [Summary Pane](#) - The **Summary Pane** displays a one line summary of each frame for every protocol found in the data, and can be sorted by field for every protocol. Click [here](#) for an explanation of the symbols next to the frame numbers.

- [Decode Pane](#) - The **Decode Pane** displays a detailed decode of the highlighted frame. Fields selected in the **Decode Pane** have the appropriate bit(s) or byte(s) selected in the **Radix, Binary, Character**, and **Event** panes
- [Radix Pane](#) - The **Radix Pane** displays the [logical data bytes](#) in the selected frame in either hexadecimal, decimal or octal.
- [Binary Pane](#) - The **Binary Pane** displays a binary representation of the logical data bytes.
- [Character Pane](#) - The **Character Pane** displays the character representation of the logical data bytes in either ASCII, EBCDIC or Baudot.
- [Event Pane](#) - The **Event Pane** displays the physical data bytes in the frame, as received on the network.

By default, all panes except the **Event Pane** are displayed when the Frame Display is first opened.

Protocol Tabs

Protocol filter tabs are displayed in the **Frame Display** above the Summary pane.

- These tabs are arranged in separate color-coded groups. These groups and their colors are General (white), *Classic Bluetooth* (blue), *Bluetooth low energy* (green), 802.11 (orange), USB (purple), NFC (brown) and SD (teal). The General group applies to all technologies. The other groups are technology-specific.



- Clicking on a protocol filter tab in the General group filters in all packets containing that protocol regardless of each packet's technology.
- Clicking on a protocol filter tab in a technology-specific group filters in all packets containing that protocol on that technology.
- A protocol filter tab appears in the General group only if the protocol occurs in more than one of the technology-specific tab groups. For example, if L2CAP occurs in both Classic Bluetooth and Bluetooth low energy, there will be L2CAP tabs in the General group, the Classic Bluetooth group, and the Bluetooth low energy group.

Select the **Unfiltered** tab to display all packets.

There are several special tabs that appear in the **Summary Pane** when certain conditions are met. These tabs appear only in the General group and apply to all technologies. The tabs are:

- **Bookmarks** appear when a bookmark is first seen.
- **Errors** appear when an error is first seen. An error is a physical error in a data byte or an error in the protocol decode.
- **Info** appears when a frame containing an Information field is first seen.

The tabs disappear when the capture buffer is cleared during live capture or when decoders are reloaded, even if one of the tabs is currently selected. They subsequently reappear as the corresponding events are detected.

Comparing Frames

If you need to compare frames, you can open additional **Frame Display** windows by clicking on the **Duplicate View** icon . You can have as many **Frame Display** windows open at a time as you wish.

Frame Wrapping and Display

In order to assure that the data you are seeing in **Frame Display** are current, the following messages appear describing the state of the data as it is being captured.

- All **Frame Display** panes except the [Summary pane](#) display "No frame selected" when the selected frame is in the buffer (i.e. not wrapped out) but not accessible in the **Summary** pane. This can happen when a tab is selected that doesn't filter in the selected frame.
- When the selected frame wraps out (regardless of whether it was accessible in the [Summary pane](#)) all **Frame Display** panes except the **Summary** pane display "Frame wrapped out of buffer".
- When the selected frame is still being captured, all **Frame Display** panes except the [Summary pane](#) display "Frame incomplete".

4.3.1.1 Frame Display Toolbar

The buttons that appear in the **Frame Display** window vary according to the particular configuration of the analyzer. For controls not available the icons will be grayed-out.

Table 4.1 - Frame Display Toolbar Icons









Icon	Description
	Control – Brings the Control window to the front.
	Open File - Opens a capture file.
	I/O Settings - Opens the I/O Settings dialog.
	Start Capture - Begins data capture to a user designated file.
	Stop Capture - Closes a capture file and stops data capture to disk.
	Save - Save the currently selected bytes or the entire buffer to file.
	Clear- Discards the temporary file and clears the display.
	Event Display – Brings the Event Display window to the front.
	Show Statistics - Opens Statistics dialog

Table 4.1 - Frame Display Toolbar Icons(continued)













Icon	Description
	Duplicate View - Creates a second Frame Display window identical to the first.
	Apply/Modify Display Filters - Opens the Display Filter dialog.
	Quick Protocol Filter - brings up a dialog box where you can filter or hide one or more protocol layers.
	Protocol Stack - brings up the Protocol Stack Wizard where you can change the stack used to decode framed data
	Reload Decoders - When Reload Decoders is clicked, the plug-ins are reset and received frames are re-decoded. For example, If the first frame occurs more than 10 minutes in the past, the 10-minute utilization graph stays blank until a frame from 10 minutes ago or less is decoded.
	Find - Search for errors, string patterns, special events and more.
	Display Capture Notes - Brings up the Capture Notes window where you can view or add notes to the capture file.
	Add/Modify Bookmark - Add a new or modify an existing bookmark.
	Display All Bookmarks - Shows all bookmarks and lets you move between bookmarks.
	Coexistence View - Opens the Coexistence View
	Extract Data - Opens the Extract Data dialog.
	Audio Extraction - Opens the Audio Extraction dialog.
	Pie Chart - This icon displays a chart that displays the number of frames with and without errors.

Table 4.1 - Frame Display Toolbar Icons(continued)













Icon	Description
<p>Reload Decoders - When Reload Decoders is clicked, the plug-ins are reset and received frames are re-decoded. For example, If the first frame occurs more than 10 minutes in the past, the 10-minute utilization graph stays blank until a frame from 10 minutes ago or less is decoded.</p>	
<p>Filter:</p>	<p>Filter: Text giving the filter currently in use. If no filter is being used, the text reads "All Frames" which means that nothing is filtered out. To see the text of the entire filter, place the cursor over the text and a ToolTip pops up with the full text of the filter.</p>
<p>The following icons all change how the panes are arranged on the Frame Display. Additional layouts are listed in the View menu.</p>	
	<p>Show Default Panes - Returns the panes to their default settings.</p>
	<p>Show Only Summary Pane - Displays only the Summary pane.</p>
	<p>Shall All Panes Except Event Pane - Makes the Decode pane taller and the Summary pane narrower.</p>
	<p>Toggle Display Lock - Prevents the display from updating.</p>
	<p>Go To Frame</p>
	<p>First Frame - Moves to the first frame in the buffer.</p>
	<p>Previous Frame - Moves to the previous frame in the buffer.</p>
	<p>Next Frame - Moves to the next frame in the buffer.</p>
	<p>Last Frame - Moves to the last frame in the buffer.</p>
<p>Find:</p>	<p>Find on Frame Display only searches the Decode Pane for a value you enter in the text box.</p>

Table 4.1 - Frame Display Toolbar Icons(continued)

Icon	Description
	Find Previous Occurrence - Moves to the previous occurrence of the value in the Frame Display Find.
	Find Next Occurrence - Moves to the next occurrence of the value in the Frame Display Find.
	Cancel Current Search - Stops the current Frame Display Find.
<p data-bbox="391 793 505 821">Summary:</p>	<p data-bbox="667 600 1138 947">Summary Drop Down Box: Lists all the protocols found in the data in the file. This box does not list all the protocol decoders available to the analyzer, merely the protocols found in the data. Selecting a protocol from the list changes the Summary pane to display summary information for that protocol. When a low energy predefined Named Filter (like Nulls and Polls) is selected, the Summary drop-down is disabled.</p> 
<p data-bbox="250 1050 1122 1108">Text with Protocol Stack: To the right of the Summary Layer box is some text giving the protocol stack currently in use.</p>	

Note: If the frames are sorted in other than ascending frame number order, the order of the frames in the buffer is the sorted order. Therefore the last frame in the buffer may not have the last frame number.

4.3.1.2 Frame Display Status Bar

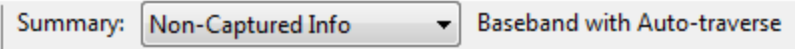
The **Frame Display Status** bar appears at the bottom of the **Frame Display**. It contains the following information:

- **Frame #s Selected:** Displays the frame number or numbers of selected (highlighted) frames, and the total number of selected frames in parentheses
- **Total Frames:** The total number of frames in the capture buffer or capture file in real-time
- **Frames Filtered In:** The total number of frames displayed in the filtered results from user applied filters in real-time

4.3.1.3 Hiding and Revealing Protocol Layers in the Frame Display

Hiding protocol layers refers to the ability to prevent a layer from being displayed on the **Decode** pane. Hidden layers remain hidden for every frame where the layer is present, and can be revealed again at any time. You can hide as many layers as you wish.

Note: Hiding from the **Frame Display** affects only the data shown in the **Frame Display** and not any information in any other window.

There are two ways to hide a layer.

1. Right-click on the layer in the **Decode** pane, and choose **Hide [protocol name] Layer In All Frames**.
2. Click the **Set Protocol Filtering** button on the **Summary** pane toolbar. In the **Protocols to Hide** box on the right, check the protocol layer(s) you want hidden. Click **OK** when finished.

To reveal a hidden protocol layer:

1. Right-click anywhere in the **Decode** pane
2. Choose **Show [protocol name] Layer** from the right-click menu, or click the **Set Protocol Filtering** button and un-check the layer or layers you want revealed.

4.3.1.4 Physical vs. Logical Byte Display

The **Event Display** window and **Event Pane** in the **Frame Display** window show the physical bytes. In other words, they show the actual data as it appeared on the circuit. The Radix, Binary and Character panes in the Frame Display window show the logical data, or the resulting byte values after escape codes or other character altering codes have been applied (a process called transformation).

As an example, bytes with a value of less than 0x20 (the 0x indicates a hexadecimal value) cannot be transmitted in Async PPP. To get around this, a 0x7d is transmitted before the byte. The 0x7d says to take the next byte and subtract 0x20 to obtain the true value. In this situation, the Event pane displays 0x7d 0x23, while the Radix pane displays 0x03.

4.3.1.5 Sorting Frames

By default, frames are sorted in ascending numerical sequence by frame number. Click on a column header in the **Summary** pane to sort the frames by that column. For example, to sort the frames by size, click on the **Frame Size** column header.

An embossed triangle next to the header name indicates which column the frames are sorted by. The direction of the triangle indicates whether the frames are in ascending or descending order, with up being ascending.

Note that it may take some time to sort large numbers of frames.

4.3.1.6 Frame Display - Find

Frame Display has a simple **Find** function that you can use to search the Decode Pane for any alpha numeric value. This functionality is in addition to the more robust [Search/Find dialog](#).

Frame Display Find is located below the toolbar on the **Frame Display** dialog.



Figure 4.16 - Frame Display Find text entry field

Where the more powerful [Search/Find](#) functionality searches the **Decode**, **Binary**, **Radix**, and **Character** panes on **Frame Display** using Timestamps, Special Events, Bookmarks, Patterns, etc.,

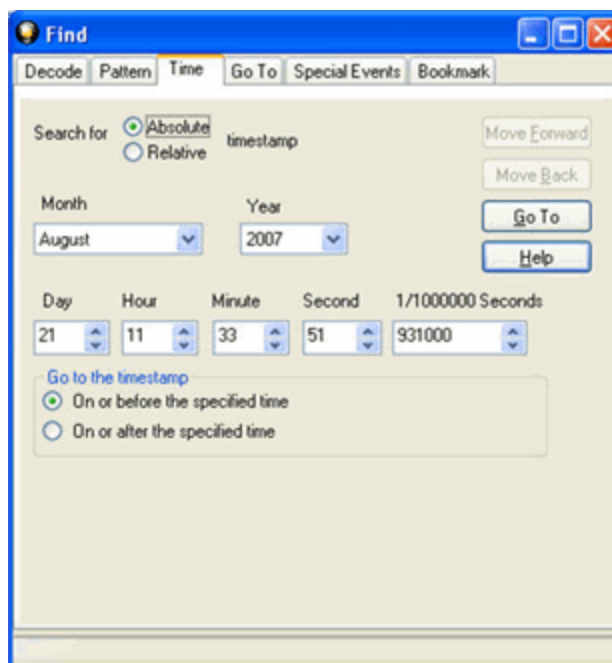
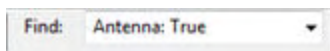

Figure 4.17 - Search/Find Dialog



Find on **Frame Display** only searches the [Decode Pane](#) for a value you enter in the text box.

To use **Find**:

1. Select the frame where you want to begin the search.
2. Enter a value in the **Find** text box.



Note: The text box is disabled during a live capture.

3. Select **Find Previous Occurrence**  to begin the search on frames prior to the frame you selected, or **Find Next Occurrence**  to begin the search on frames following the frame you selected.



The next occurrence of the value (if it is found) will be highlighted in the Decode Pane.

4. Select **Find Previous Occurrence** or **Find Next Occurrence** to continue the search.

There are several important concepts to remember with Find.

- When you enter a search string and select Enter, the search moves forward.
- If you select **Find Previous Occurrence**, when the search reaches the first frame it will then cycle to the last frame and continue until it reaches the frame where the search began.
- Shift + F3 is a shortcut for Find Previous Occurrence.
- If you select **Find Next Occurrence**, when the search reaches the last frame it will then cycle to the first frame and continue until it reaches the frame where the search began.
- F3 is a shortcut for Find Next Occurrence.
- You cannot search while data is being captured.
- After a capture is completed, you cannot search until Frame Display has finished decoding the frames.
- Find is not case sensitive.

- The status of the search is displayed at the bottom of the dialog.

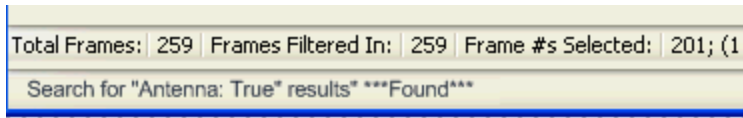

- The search occurs only on the protocol layer selected.

- To search across all the protocols on the Frame Display, select the Unfiltered tab.

- A drop-down list displays the search values entered during the current session of Frame Display.

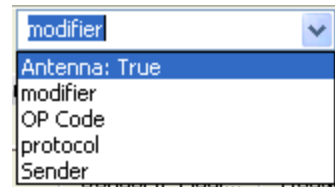

- The search is cancelled when you select a different protocol tab during a search.

- You can cancel the search at any time by selecting the **Cancel Current Search**  button.

4.3.1.7 Synchronizing the Event and Frame Displays

The **Frame Display** is synchronized with the **Event Display**. Click on a frame in the **Frame Display** and the corresponding bytes is highlighted in the **Event Display**. Each **Frame Display** has its own **Event Display**.

As an example, here's what happens if the following sequence of events occurs.

1. Click on the **Frame Display** icon  in **Control** window toolbar to open the **Frame Display**.
2. Click on the **Duplicate View** icon  to create **Frame Display #2**.
3. Click on **Event Display** icon  in **Frame Display #2**. **Event Display #2** opens. This **Event Display** is labeled #2, even though there is no original **Event Display**, to indicate that it is synchronized with **Frame Display #2**.
4. Click on a frame in **Frame Display #2**. The corresponding bytes are highlighted in **Event Display #2**.
5. Click on a frame in the original **Frame Display**. **Event Display #2** does not change.

4.3.1.8 Working with Multiple Frame Displays

Multiple Frame Displays are useful for comparing two frames side by side. They are also useful for comparing all frames against a filtered subset or two filtered subsets against each other.

- To create a second Frame Display, click the **Duplicate View** icon  on the **Frame Display** toolbar.

This creates another **Frame Display** window. You can have as many **Frame Displays** open as you wish. Each **Frame Display** is given a number in the title bar to distinguish it from the others.
- To navigate between multiple Frame Displays, click on the **Frame Display** icon  in the Control window toolbar.



A drop-down list appears, listing all the currently open Frame Displays.
- Select the one you want from the list and it comes to the front.

Note: When you create a filter in one **Frame Display**, that filter does not automatically appear in the other **Frame Display**. You must use the Hide/Reveal feature to display a filter created in one Frame Display in another.

Note: When you have multiple **Frame Display** windows open and you are capturing data, you may receive an error message declaring that "Filtering cannot be done while receiving data this fast." If this occurs, you may have to stop filtering until the data is captured.

4.3.1.9 Working with Panes on Frame Display

When the **Frame Display** first opens, all panes are displayed except the **Event** pane (To view all the panes, select **Show All Panes** from the **View** menu).

- The **Toggle Expand Decode Pane** icon  makes the decode pane longer to view lengthy decodes better.
- The **Show Default Panes** icon  returns the **Frame Display** to its default settings.

- The Show only Summary Pane icon  displays on the Summary Pane.

To close a pane, right-click on the pane and select **Hide This Pane** from the pop-up menu, or de-select **Show [Pane Name]** from the **View** menu.

To open a pane, right-click on the any pane and select **Show Hidden Panes** from the pop-up menu and select the pane from the fly-out menu, or select **Show [Pane Name]** from the **View** menu.

To re-size a pane, place the cursor over the pane border until a double-arrow cursor appears. Click and drag on the pane border to re-size the pane.

4.3.1.10 Frame Display - Byte Export

The captured frames can be exported as raw bytes to a text file.

1. From the **Frame Display File** menu select **Byte Export...**

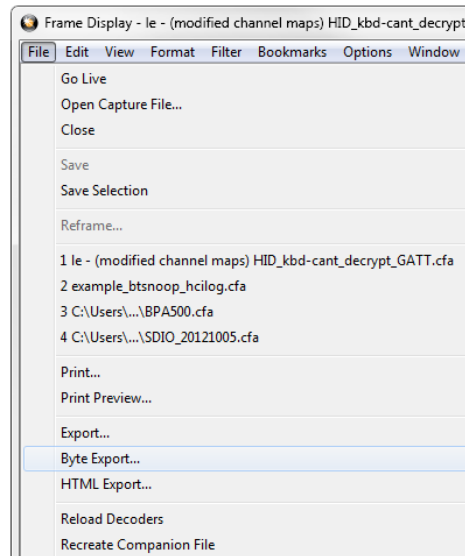

Figure 4.18 - Frame Display File menu, Byte Export

2. From the Byte Export window specify the frames to export.
 - All Frames exports all filtered-in frames including those scrolled off the **Summary** pane. Filtered-in frames are dependent on the selected **Filter** tab above the **Summary** pane. Filtered-out frames are not exported.
 - Selected Frames export is the same as **All Frames** export except that only frames selected in the **Summary** pane will be exported.

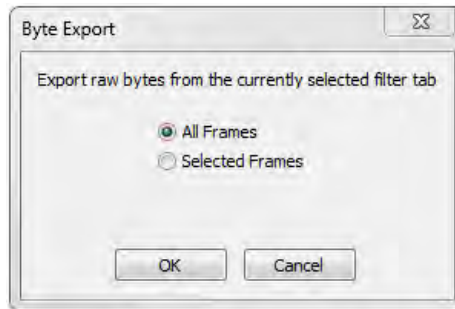

Figure 4.19 - Byte Export dialog

Click the **OK** button to save the export. Clicking the **Cancel** button will exit Byte Export.

3. The **Save As** dialog will open. Select a directory location and enter a file name for the exported frames file.

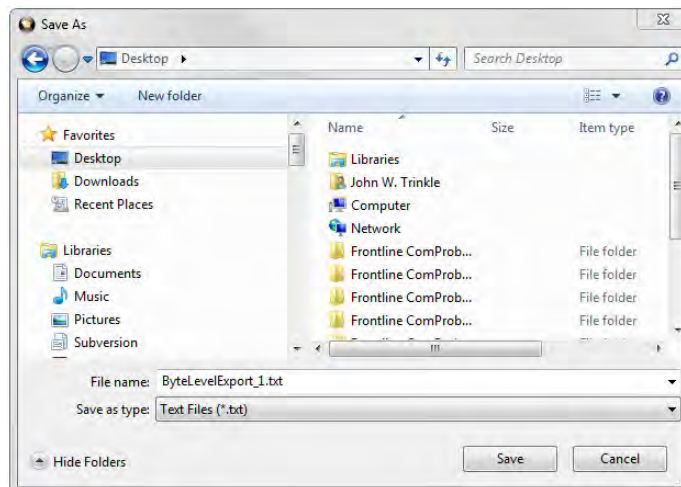

Figure 4.20 - Save As dialog

Click on the **Save** button.

The exported frames are in a text file that can be opened in any standard text editing application. The header shows the export type, the capture file name, the selected filter tab, and the number of frames. The body shows the frame number, the timestamp in the same format shown in the **Frame Display Summary** pane, and the frame contents as raw bytes.

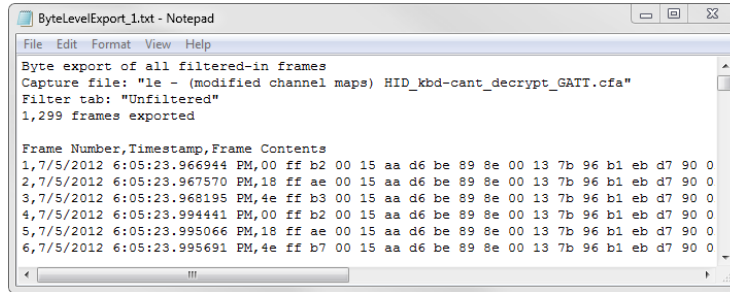



Figure 4.21 - Sample Exported Frames Text File

4.3.1.11 Panes in the Frame Display

4.3.1.11.1 Summary Pane

The **Summary** pane  displays a one-line summary of every frame in a capture buffer or file, including frame number, timestamp, length and basic protocol information. The protocol information included for each frame depends on the protocol selected in the summary layer box (located directly below the main toolbar).

On a two-channel circuit, the background color of the one-line summary indicates whether the frame came from the DTE or the DCE device. Frames with a white background come from the DTE device, frames with a gray background come from the DCE device.

Frame numbers in red indicate errors, either physical (byte-level) or frame errors. If the error is a frame error in the displayed protocol layer, the bytes where the error occurred is displayed in red. The [Decode Pane](#) gives precise information as to the type of error and where it occurred.

The **Summary** pane is synchronized with the other panes in this window. Click on a frame in the **Summary** pane, and the bytes for that frame is highlighted in the **Event** pane while the **Decode** pane displays the full decode for that frame. Any other panes which are being viewed are updated accordingly. If you use one pane to select a subset of the frame, then only that subset of the frame is highlighted in the other panes.

Protocol Tabs

Protocol filter tabs are displayed in the Frame Display above the Summary pane.

- These tabs are arranged in separate color-coded groups. These groups and their colors are General (white), Classic *Bluetooth* (blue), *Bluetooth* low energy (green), 802.11 (orange), USB (purple), and SD (brown). The General group applies to all technologies. The other groups are technology-specific.



Figure 4.22 - Example Protocol Tags

- Clicking on a protocol filter tab in the General group filters in all packets containing that protocol regardless of each packet's technology.
- Clicking on a protocol filter tab in a technology-specific group filters in all packets containing that protocol on that technology.
- A protocol filter tab appears in the General group only if the protocol occurs in more than one of the technology-specific tab groups. For example, if L2CAP occurs in both Classic *Bluetooth* and *Bluetooth* low energy, there will be L2CAP tabs in the General group, the Classic *Bluetooth* group, and the *Bluetooth* low energy group.



Select the Unfiltered tab to display all packets.

There are several special tabs that appear in the **Summary** pane when certain conditions are met. These tabs appear only in the General group and apply to all technologies. The tabs are:

- **Bookmarks** appear when a bookmark is first seen.
- **Errors** appear when an error is first seen. An error is a physical error in a data byte or an error in the protocol decode.
- **Info** appears when a frame containing an Information field is first seen.

The tabs disappear when the capture buffer is cleared during live capture or when decoders are reloaded, even if one of the tabs is currently selected. They subsequently reappear as the corresponding events are detected.

The tabs disappear when the capture buffer is cleared during live capture or when decoders are reloaded, even if one of the tabs is currently selected. They subsequently reappear as the corresponding events are detected.

Use the navigation icons, keyboard or mouse to move through the frames. The icons  and  move you to the first and last frames in the buffer, respectively. Use the [Go To](#) icon  to move to a specific frame number.

Placing the mouse pointer on a summary pane header with truncated text displays a tooltip showing the full header text.

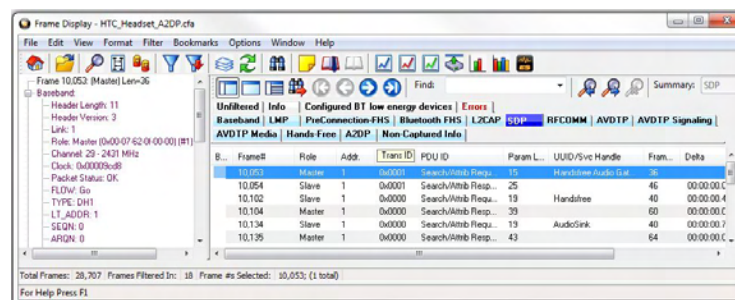

Figure 4.23 - Summary pane (right) with Tooltip on Column 5 (Tran ID)

4.3.1.11.2 Customizing Fields in the Summary Pane

You can modify the **Summary** Pane in **Frame Display**.

Summary pane columns can be reordered by dragging any column to a different position.

Fields from the **Decode** pane can be added to the summary pane by dragging any **Decode**pane field to the desired location in the **summary** pane header. If the new field is from a different layer than the summary pane a plus sign (+) is prepended to the field name and the layer name is added in parentheses. The same field can be added more than once if desired, thus making it possible to put the same field at the front and back (for example) of a long header line so that the field is visible regardless of where the header is scrolled to.

An added field can be removed from the **Summary** pane by selecting **Remove New Column** from the right-click menu.

The default column layout (both membership and order) can be restored by selecting **Restore Default Columns** from the **Format** or right-click menus.

Changing Column Widths

To change the width of a column:

1. Place the cursor over the right column divider until the cursor changes to a solid double arrow.
2. Click and drag the divider to the desired width.
3. To auto-size the columns, double-click on the column dividers.

Hiding Columns

To hide a column:

1. Drag the right divider of the column all the way to the left.
2. The cursor changes to a split double arrow when a hidden column is present.
3. To show the hidden column, place the cursor over the divider until it changes to a split double arrow, then click and drag the cursor to the right.
4. The **Frame Size**, **Timestamp**, and **Delta** columns can be hidden by right-clicking on the header and selecting **Show Frame Size Column**, **Show Timestamp Column**, or **Show Delta Column**. Follow the same procedure to display the columns again.

Moving Columns - Changing Column Order

To move a column :

1. Click and hold on the column header
2. Drag the mouse over the header row.
3. A small white triangle indicates where the column is moved to.
4. When the triangle is in the desired location, release the mouse.



Restoring Default Column Settings

To restore columns to their default locations, their default widths, and show any hidden columns

1. Right-click on any column header and choose **Restore Default Column Widths**, or select **Restore Default Column Widths** from the **Format** menu.

4.3.1.11.3 Frame Symbols in the Summary Pane

Table 4.2 - Frame Symbols

Symbol	Description
	A green dot means the frame was decoded successfully, and the protocol listed in the Summary Layer drop-down box exists in the frame. No dot means the frame was decoded successfully, but the protocol listed in the Summary Layer drop-down box does not exist in the frame.
	A green circle means the frame was not fully decoded. There are several reasons why this might happen. <ul style="list-style-type: none"> One reason is that the frame compiler hasn't caught up to that frame yet. It takes some time for the analyzer to compile and decode frames. Frame compilation also has a lower priority than other tasks, such as capturing data. If the analyzer is busy capturing data, frame compilation may fall behind. When the analyzer catches up, the green circle changes to either a green dot or no dot. Another reason is if some data in the frame is context dependent and we don't have the context. An example is a compressed header where the first frame gives the complete header, and subsequent frames just give information on what has changed. If the analyzer does not capture the first frame with the complete header, it cannot decode subsequent frames with partial header information.
	A magenta triangle indicates that a bookmark is associated with this frame. Any comments associated with the bookmark appear in the column next to the bookmark symbol.

4.3.1.11.4 Decode Pane

The **Decode** pane (aka detail pane)  is a post-process display that provides a detailed decode of each frame

transaction (sometimes referred to as a frame). The decode is presented in a layered format that can be expanded and collapsed depending on which layer or layers you are most interested in. Click on the plus sign to expand a layer. The plus sign changes to a minus sign. Click on the minus sign to collapse a layer. **Select Show All** or **Show Layers** from the **Format** menu to expand or collapse all the layers. Layers retain their expanded or collapsed state between frames.

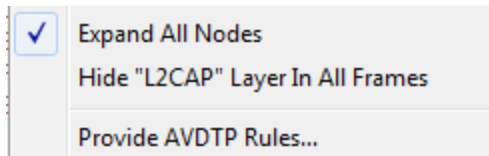

Protocol layers can be hidden, preventing them from being displayed on the **Decode** pane. Right-click on any protocol layer and choose **Hide** [protocol name] from the right-click menu.

Each protocol layer is represented by a [color](#), which is used to highlight the bytes that belong to that protocol layer in the **Event**, **Radix**, **Binary** and **Character** panes. The colors are not

assigned to a protocol, but are assigned to the layer.

The **Event**, **Radix**, **Binary**, **Character** and **Decode** panes are all synchronized with one another. Clicking on an element in any one of the panes highlights the corresponding element in all the other panes.

Click the **Toggle Expand Decode Pane** icon  to make the **Decode** pane taller. This allows for more of a lengthy decode to be viewed without needing to scroll.

4.3.1.11.5 Radix or Hexadecimal Pane

The **Radix** pane displays the logical bytes in the frame in either hexadecimal, decimal or octal. The radix can be changed from the **Format** menu, or by right-clicking on the pane and choosing **Hexadecimal**, **Decimal** or **Octal**.

Because the Radix pane displays the logical bytes rather than the physical bytes, the data in the Radix pane may be different from that in the Event pane. See [Physical vs. Logical Byte Display](#) for more information.

[Colors](#) are used to show which protocol layer each byte belongs to. The colors correspond to the layers listed in the Decode pane.

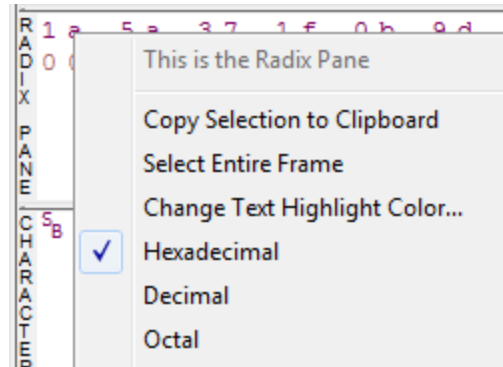

The Event, Radix, Binary, Character and Decode panes are all synchronized with one another. Clicking on an element in any one of the panes highlights the corresponding element in all the other panes.

4.3.1.11.6 Character Pane

The **Character** pane represents the logical bytes in the frame in **ASCII**, **EBCDIC** or **Baudot**. The character set can be changed from the **Format** menu, or by right-clicking on the pane and choosing the appropriate character set.

Because the **Character** pane displays the logical bytes rather than the physical bytes, the data in the **Character** pane may be different from that in the **Event** pane. See [Physical vs. Logical Byte Display](#) for more information.

[Colors](#) are used to show which protocol layer each byte belongs to. The colors correspond to the layers listed in the **Decode** pane.

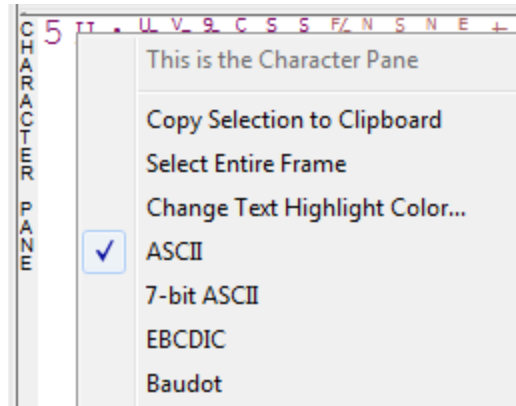

The **Event**, **Radix**, **Binary**, **Character** and **Decode** panes are all synchronized with one another. Clicking on an element in any one of the panes highlights the corresponding element in all the other panes.

4.3.1.11.7 Binary Pane

The **Binary** pane displays the logical bytes in the frame in binary.

Because the **Binary** pane displays the logical bytes rather than the physical bytes, the data in the Binary pane may be different from that in the **Event** pane. See [Physical vs. Logical Byte Display](#) for more information.

[Colors](#) are used to show which protocol layer each byte belongs to. The colors correspond to the layers listed in the **Decode** pane.

The **Event**, **Radix**, **Binary**, **Character** and **Decode** panes are all synchronized with one another. Clicking on an element in any one of the panes highlights the corresponding element in all the other panes.

4.3.1.11.8 Event Pane

The **Event** pane shows the physical bytes in the frame. You can choose between displaying only the data events or displaying all events by clicking the **All Events** icon .

Displaying all events means that special events, such as **Start of Frame**, **End of Frame** and any signal change events, are displayed as special symbols within the data.

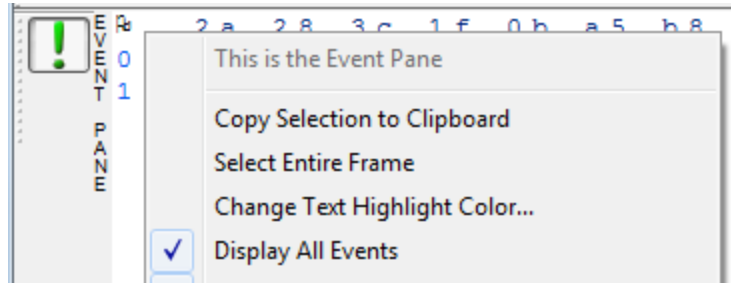

The status lines at the bottom of the pane give the same information as the status lines in the **Event Display** window. This includes physical data errors, control signal changes (if appropriate), and timestamps.

Because the **Event** pane displays the physical bytes rather than the logical bytes, the data in the **Event** pane may be different from that in the **Radix**, **Binary** and **Character** panes. See [Physical vs. Logical Byte Display](#) for more information.

[Colors](#) are used to show which protocol layer each byte belongs to. The colors correspond to the layers listed in the Decode pane.

The **Event**, **Radix**, **Binary**, **Character** and **Decode** panes are all synchronized with one another. Clicking on an element in any one of the panes highlights the corresponding element in all the other panes.

4.3.1.11.9 Change Text Highlight Color

Whenever you select text in the **Binary**, **Radix**, or **Character** panes in **Frame Display**, the text is displayed with a highlight color. You can change the color of the highlight.

1. Select **Change Text Highlight Color** from the **Options** menu. You can also access the option by right clicking in any of the panes.
2. Select a color from the drop-down menu.
3. Click **OK**.



The highlight color for the text is changed.

Select **Cancel** to discard any selection. Select **Defaults** to return the highlight color to blue.

4.3.1.12 Protocol Layer Colors

4.3.1.12.1 Data Byte Color Notation

The color of the data in the panes specifies which layer of the protocol stack the data is from. All data from the first layer is bright blue, the data from the second layer is green, the third layer is pink, etc. The protocol name for each layer in the **Decode** pane is in the same color. Note that the colors refer to the layer, not to a specific

protocol. In some situations, a protocol may be in two different colors in two different frames, depending on where it is in the stack. You can [change the default colors](#) for each layer.

Red is reserved for bytes or frames with errors. In the **Summary** pane, frame numbers in red mean there is an error in the frame. Also, the **Errors** tab is displayed in red. This could be a physical error in a data byte or an error in the protocol decode. Bytes in red in the **Radix, Character, Binary** and **Event** panes mean there is a physical error associated with the byte.

4.3.1.12.2 Red Frame Numbers and Bytes

Red is reserved for bytes or frames with errors. In the Summary pane, frame numbers in red mean there is an error in the frame. This could be a physical error in a data byte or an error in the protocol decode.

4.3.1.12.3 Changing Protocol Layer Colors

You can differentiate different protocol layers in the **Decode, Event, Radix, Binary** and **Character** panes.

1. Choose **Select Protocol Layer Colors** from the **Options** menu to change the colors used.
The colors for the different layers is displayed.
2. To change a color, click on the arrow next to each layer and select a new color.
3. Select **OK** to accept the color change and return to **Frame** Display.

Select **Cancel** to discard any selection. Select **Defaults** to return the highlight colors to the default settings.



Figure 4.24 - Frame Display Protocol Layer Color Selector

4.3.1.13 Filtering

Filtering allows the user to control the display which capture frames are displayed. Filters fall into two general categories:

1. **Display filters** allow a user to look at a subset of captured data without affecting the capture content. Frames matching the filter criteria appear in the **Frame Display**; frames not matching the criteria will not

appear.

2. **Connection filters** Two options are available.

- a. A Bluetooth connection: Displays only the frames associated with a Classic *Bluetooth* link or a *Bluetooth* low energy access address. A new **Frame Display** will open showing only the protocol tabs, frames, summary, and events associated with that particular *Bluetooth* connection.
- b. A specific wireless or wired technology. Displays all of the frames associated with:
 - Classic *Bluetooth*
 - *Bluetooth* low energy
 - 802.11
 - HCI

A new Frame Display will open showing only the protocol tabs, frames, summary and events associated with the selected technology.

4.3.1.13.1 Display Filters

A display filter looks at frames that have already been captured. It looks at every frame in the capture buffer and displays those that match the filter criteria. Frames that do not match the filter criteria are not displayed. Display filters allow a user to look at a subset of captured data without affecting the capture content. There are three general classes of display filters:

- Protocol Filters
- Named Filters
- Quick Filter

Protocol Filters

Protocol filters test for the existence of a specific single layer. The system creates a protocol filter for each decoder that is loaded if that layer is encountered in a capture session.

There are also three special purpose filters that are treated as protocol filters:

- All Frames with Errors
- All Frames with Bookmarks
- All Special Information Nodes

Named Filters



- Named filters test for anything other than simple single layer existence. Named filters can be constructed that test for the existence of multiple layers, field values in layers, frame sizes, etc., as well as combinations of those things. Named filters are persistent across sessions.
- Named filters are user-defined. User-defined filters persist in a template file. User defined filters can be deleted.

Quick Filters

- Quick Filters are combinations of Protocol Filters and/or Named Filters that are displayed on the Quick Filter tab.
- Quick Filters cannot be saved and do not persist across sessions.
- Quick Filters are created on the Quick Filter Dialog.

4.3.1.13.1.1 Creating a Display Filter

There are two steps to using a display filter. Define the filter conditions, and then apply the filter to the data set. The system combines both filter definition and application in one dialog.

1. Click the **Display Filters** icon  on the **Frame Display**  window or select **Apply/Modify Display Filters** from the **Filter** menu to open the **Set Condition** dialog box. The Set Condition dialog is self configuring which means that when you **Select each frame** under **Conditions** the following displayed fields depend on your selection. With each subsequent selection the dialog fields will change depending on you selection in that field.

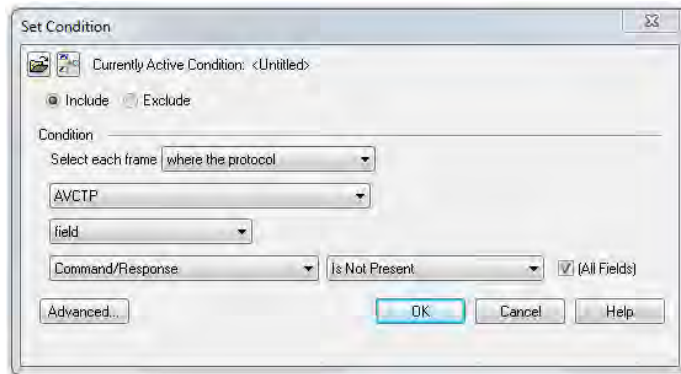

Figure 4.25 - Example: Set Conditions Self Configuring Based on Protocol Selection

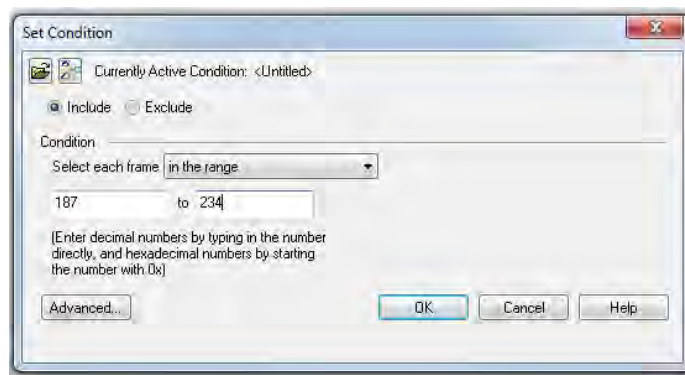

Figure 4.26 - Example: Set Conditions Self Configuring Based on Frame Range

2. Select **Include** or **Exclude** to add filtered data or keep out filtered data respectively.
3. Select the initial condition for the filter from the drop-down list.

4. Set the parameters for the selected condition in the fields provided. The fields that appear in the dialog box are dependent upon the previous selection. Continue to enter the requested parameters in the fields provided until the condition statement is complete.
5. Click OK. The system displays the **Save Named Condition** dialog. Provide a name for the filter condition or accept the default name provided by the system and click **OK**. Prohibited characters are left bracket '[', right bracket ']' and equal sign '='. The **Set Condition** dialog box closes, creates a tab on the **Frame Display** with the filter name, and applies the filter.

The filter also appears in the [Quick Filtering and Hiding Protocols](#) dialog.

When a display filter is applied, a description of the filter appears to the right of the toolbar in the **Frame Display** windows.

Notes:

- The system requires naming and saving of all filters created by the user.
- The **OK** button on the **Set Condition** dialog box is unavailable (grayed out) until the condition selections are complete.
- When you have [multiple Frame Display windows](#) with a display filter or filters, those filter do not automatically appear in other **Frame Display** windows. You must use the [Hide/Reveal](#) feature to display a filter created in one Frame Display in different **Frame Display** window.

4.3.1.13.1.2 Including and Excluding Radio Buttons

All filter dialog boxes contain an **Include** and an **Exclude** radio button. These buttons are mutually exclusive. The **Include/Exclude** selection becomes part of the filter definition, and appears as part of the filter description displayed to the right of the Toolbar.

Include: A filter constructed with the "Include" button selected, returns a data set that includes frames that meet the conditions defined by the filter and omits frames that do not.

Exclude: A filter constructed with the "Exclude" button selected, returns a data set that excludes frames that meet the conditions defined by the filter and consists of frames that do not.

4.3.1.13.1.3 Named Display Filters

You can create a unique display filter by selecting a data type on the **Frame Display** and using a right click menu. When you create a **Name Filter**, it appears in the [Quick Filtering](#) dialog, where you can use it to customize the data you see in the **Frame Display** panes.

1. Select a frame in the **Frame Display Summary** Pane.
2. Right click in the one of the data columns in the **Summary** Pane: CRC, NESN, DS, Packet Success, Ethertype, Source Address, etc.

3. Select **Filter in (data type) =**. The **Filtering Results** dialog appears.
4. Enter a name for the filter
5. Select **OK**.

The filter you just created appears in the **Named Filters** section of the [Quick Filtering](#) dialog.

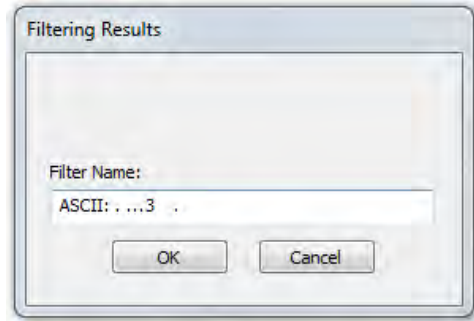

4.3.1.13.1.4 Using Compound Display Filters

Compound filters use boolean logic to create complex and precise filters. There are three primary Boolean logic operators: **AND**, **OR**, and **NOT**.

The **AND** operator narrows the filter, the **OR** operator broadens the filter, and the **NOT** operator excludes conditions from the filtered results. Include parentheses in a compound filter to nest condition sets within larger condition sets, and force the filter-processing order.

There are two steps to using a compound filter. Define the filter conditions, and then apply the filter to the data set. The analyzer combines both filter definition and application in one dialog.

1. Click the **Display Filters** icon  on the **Frame Display** window or select **Apply/Modify Display Filters...** from the filter menu to open the **Set Condition** dialog box.
2. Click the **Advanced** button on the **Set Condition** dialog box.
3. Select **Include** or **Exclude** radio button.

Now you can set the conditions for the filter.

4. Select the initial condition for the filter from the combo box at the bottom of the dialog for **Select each frame**.
5. Set the parameters for the selected condition in the fields provided. The fields that appear in the dialog box are dependent upon the previous selection. Continue to enter the requested parameters in the fields provided until the conditions statement is complete.

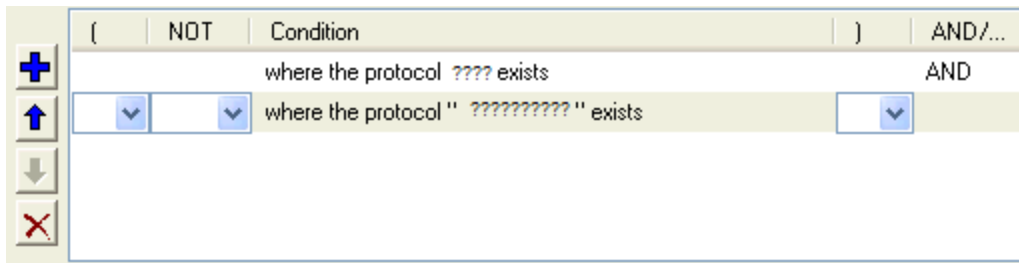
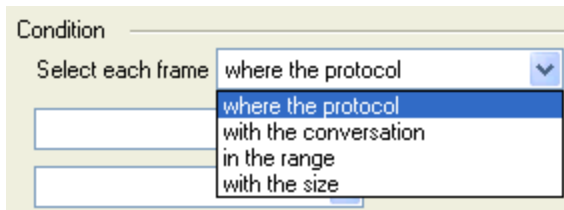





Figure 4.27 - Two Filter Conditions Added with an AND Operator

6. Click the plus icon  on the left side of the dialog box and repeat steps 4 and 5 for the next condition.
Use the up  and down  arrow icons on the left side of the dialog box to order your conditions, and the delete button  to delete conditions from your filter.
7. Continue adding conditions until your filter is complete.
8. Include parentheses as needed and set the boolean operators.
9. Click **OK**.
10. The system displays the **Save Named Condition** dialog. Provide a name for the filter condition or accept the default name provided by the system and click **OK**.

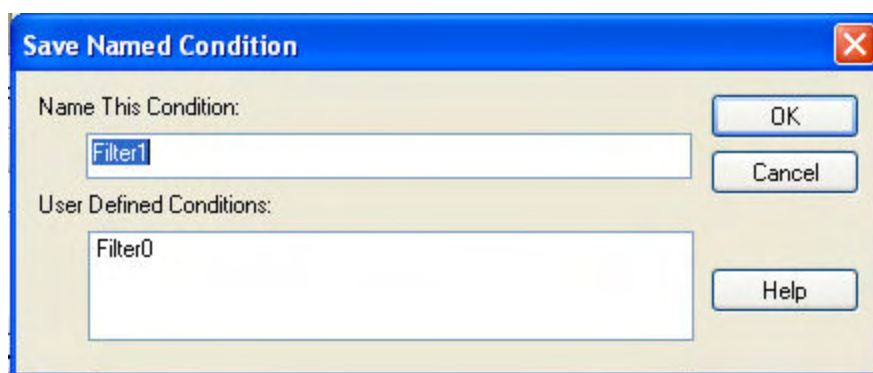

Figure 4.28 - Save Named Filter Condition Dialog

The **Set Condition** dialog box closes, creates a tab on the **Frame Display** with the filter name, and applies the filter.

Filter: Include each frame where the protocol Data exists

When a display filter is applied, a description of the filter appears to the right of the toolbar in the **Frame Display** windows.

Note: The **OK** button on the **Set Condition** dialog box is unavailable (grayed out) until the condition selections are complete.

4.3.1.13.1.5 Defining Node and Conversation Filters

There are two steps to using Node and Conversation display filter. Define the filter conditions, and then apply the filter to the data set. The analyzer combines both filter definition and application in one dialog.

1. Click the **Display Filters** icon  on the **Frame Display** window or select **Apply/Modify Display Filters...** from the filter menu to open the **Set Condition** dialog box.
2. From the **Select each frame** combo box choose **frames with the conversation** as the initial condition.
3. Select an address type—IP, MAC, TCP/UDP—from the **Type** combo box (The address type selection populates both Address combo boxes with node address in the data set that match the type selection).

4. Select a node address from the first **Address** combo box.
5. Choose a direction arrow from the direction box . The left arrow filters on all frames where the top node address is the destination, the right arrow filters on all frames where the top node address is the source, and the double arrow filters on all frames where the top node address is either the source or the destination.
6. If you want to filter on just one node address, skip step 7 and continue with step 8.
7. If you want to filter on traffic going between two address nodes (i.e. a conversation), select a node address from the second Address combo box..
8. Click **OK**. The **Set Condition** dialog box closes and the analyzer applies the filter.



When a display filter is applied, a description of the filter appears to the right of the toolbar in the **Frame Display** windows.

Note: The **OK** button is unavailable (grayed out) until the condition selections are complete.

4.3.1.13.1.6 The Difference Between Deleting and Hiding Display Filters

If you wish to remove a filter from the system permanently, then use the [Delete](#) procedure. However, if all you want to do is remove a filter as a means to un-clutter the display, then use the [Hide](#) procedure.

Deleting a saved filter removes the filter from the current session and all subsequent sessions. In order to retrieve a deleted filter, the user must recreate it using the **Set Conditions** dialog.

Hiding a filter merely removes the filter from the display. A hidden filter can be reapplied using the [Show/Hide](#) procedure.

Deleting Saved Display Filters

1. Select **Delete Display Filters** from the **Filter** menu in the **Frame Display**  window to open the **Delete Named Condition** dialog. The system displays the **Delete Named Condition** dialog with a list of all user defined filters.
2. Select the filter to be deleted from the list.
3. Click the **Delete** button.
4. Click **OK**. The **Delete Named Condition** dialog box closes and the system deletes the filter.

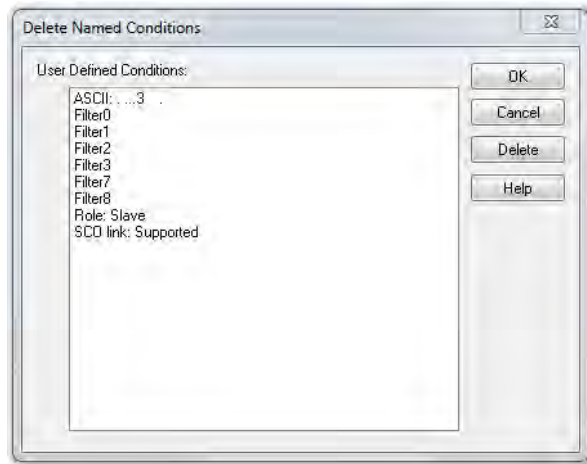

Hiding and Revealing Display Filters

If a display filter is showing the following steps will hide that filter but will not delete it.

1. Select **Hide/Show Display Filters...** from the **Filter** menu on the **Frame Display**  window to open

the **Hide/Show Filters** dialog. The system displays the **Hide/Show Filters** dialog with a list of all user defined filters.

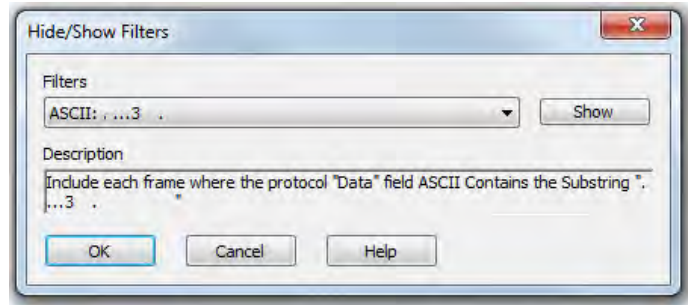

2. Select the filter to be hidden from the combo box.
3. Click the **Hide** button. The **Hide** button is only showing if the selected filter is currently showing in the **Frame Display**.
4. Click **OK**. The **Hide/Show Filters** dialog box closes, and the system hides the filter and removes the filter tab from the Frame Display.

If a display filter is hidden the following steps will reveal that filter in the **Frame Display**.

1. Select **Hide/Show Display Filters...** from the **Filter** menu in the **Frame Display**  window to open the **Hide/Show Filters** dialog. The system displays the **Hide/Show Filters** dialog with a list of all user defined filters.
2. Select the filter to be revealed from the combo box.
3. Click the **Show** button.
4. Click **OK**. The **Hide/Show Filters** dialog box closes and the system reveals the filter in the **Frame Display**.

You can also open the [Quick Filter](#) dialog and check the box next to the hidden filter to show or hide a display filter.

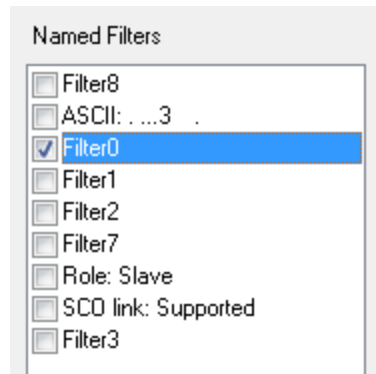



Figure 4.29 - Using Named Filters Section of Quick Filters to Show/Hide Filters

Note: When you have [multiple Frame Display windows](#) with a display filter or filters, those filter do not automatically appear in other Frame Display windows. You must use the Hide/Show dialog to display a filter created in one Frame Display in different Frame Display window.

4.3.1.13.1.7 Editing Filters

Modifying a Condition in a Filter

1. Click the **Display Filters** icon  on the **Frame Display** window or select **Apply/Modify Display Filters...** from the **Filter** menu to open the **Set Condition** dialog box. The **Set Condition** dialog box displays the current filter definition at the top of the dialog.

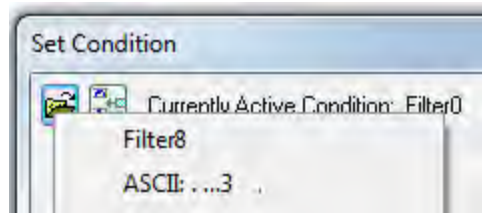



To display another filter, click the **Open**  icon, and select the filter from the pop-up list of all the saved filters.

2. Edit the desired parameter of the condition: Because the required fields for a condition statement depend upon previously selected parameters, the Set Condition dialog box may display additional fields that were not present in the original filter. In the event this occurs, continue to enter the requested parameters in the fields provided until the condition statement is complete.
3. Click **OK**. The system displays the **Save Named Condition** dialog. Ensure that the filter name is displayed in the text box at the top of the dialog, and click **OK**. If you choose to create an additional filter, then provide a new name for the filter condition or accept the default name provided by the system and click **OK**.) The **Set Condition** dialog box closes, and the system applies the modified filter.

Note: When a display filter is applied, a description of the filter appears to the right of the toolbar in the Frame Display windows.

Deleting a Condition in a Filter

If a display filter has two or more conditions you can delete conditions. If there is only one condition set in the filter you must delete the filter using **Delete Display Filters...** from the **Filters** menu.

1. Click the **Display Filters** icon  on the **Frame Display** window or select **Apply/Modify Display Filters...** from the **Filter** menu to open the **Set Condition** dialog box. Click on the Advanced button to show the condition in Boolean format. The dialog box displays the current filter definition. To display another filter, click the **Open**  icon, and select the filter from the pop-up list of all the saved filters.

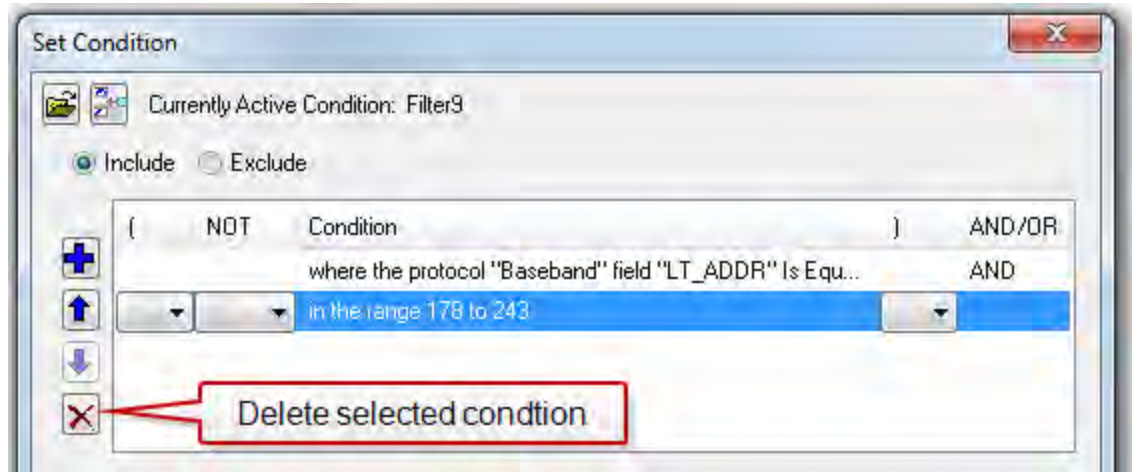



Figure 4.30 - Set Condition Dialog in Advanced View

2. Select the desired condition from the filter definition.
3. Click the **Delete Selected Line**  icon.
4. Edit the Boolean operators and parentheses as needed.
5. Click **OK**. The system displays the **Save Named Condition** dialog. Ensure that the filter name is displayed in the text box at the top of the dialog, and click **OK**. (If you choose to create an additional filter, then provide a new name for the filter condition or accept the default name provided by the system and click **OK**.) The **Set Condition** dialog box closes, and the system applies the modified filter.

Note: When a display filter is applied, a description of the filter appears to the right of the toolbar in the **Frame Display** windows.

Renaming a Display Filter

1. Select **Rename Display Filters...** from the **Filter** menu in the **Frame Display**  window to open the **Rename Filter** dialog. The system displays the **Rename Filter** dialog with a list of all user defined filters in the **Filters** combo box.

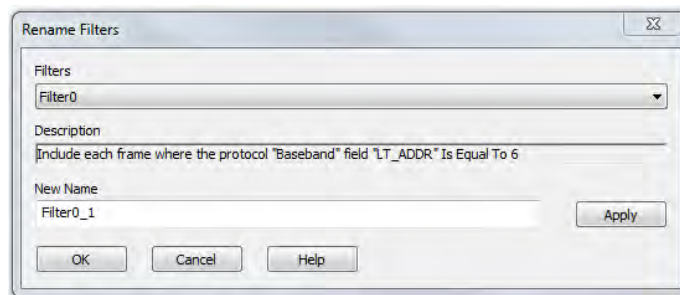

Figure 4.31 - Rename Filters Dialog

2. Select the filter to be renamed from the combo box.

3. Enter a new name for the filter in the **New Name** box. Optionally click the **Apply** button and the new name will appear in the **Filters** combo box and the **New Name** box will empty. This option allows you to rename several filters without closing the **Rename Filter** dialog each time.
4. Click **OK**. The **Rename Filter** dialog box closes and the system renames the filter.

4.3.1.13.2 Connection Filtering

Connection Filtering allows the user to view a subset of the total available packets within the **Frame Display**. The subset can include data from a single *Bluetooth* connection, or all of the BR/EDR packets, all of the low energy packets, all of the 802.11 packets, or all of the HCI packets.

Bluetooth Applicability

A connection (device pair) is identified by

1. A Link for Classic *Bluetooth*,
2. An Access Address for *Bluetooth* low energy.

The link ID is a number that the ComProbe software assigns to identify a pair of devices in a BR/EDR connection. In the **Frame Display** details pane, the Baseband layer contains the link ID field if the field's value is not 0.

An Access Address is contained in every *Bluetooth* low energy packet. The Access Address identifies a connection between a slave and a master or an advertising packet.

Connection filtering displays only the frames, protocols, summary, details, and events for the selected connections.

Note: Connection Filters are not persistent across sessions.

4.3.1.13.2.1 Creating a Connection Filter

In the Frame Display there are four ways to create a connection filter.

From the Frame Display Filter menu

Click on the **Frame Display Filter** menu **Connection Filter** selection. From the drop down menu, select **Classic** or **Bluetooth low energy**. The options are

- *Classic Bluetooth*:
 - **All** will filter in all *Classic Bluetooth* frames. You are in effect filtering out any *Bluetooth* low energy frames and are selecting to filter in all the *Classic Bluetooth* links.
 - **Links** displays all the master-slave links. You can select only one link to filter in. The selected link will filter in only the frames associated with that link.
- *Bluetooth low energy*:
 - **All** will filter in all *Bluetooth* low energy frames. You are in effect filtering out any *Classic Bluetooth* frames and are selecting to filter in all *Bluetooth* low energy access addresses.
 - **Access Addresses** displays all the low energy slave device's access address. You can select only one access address to filter. The selected link will filter in only the frames associated with that access address.

- 802.11:
 - **All** will filter in all 802.11 frames. You are in effect filtering out any other technology frames.
- HCI:
 - **All** will filter in all HCI frames. You are in effect filtering out any other technology frames.

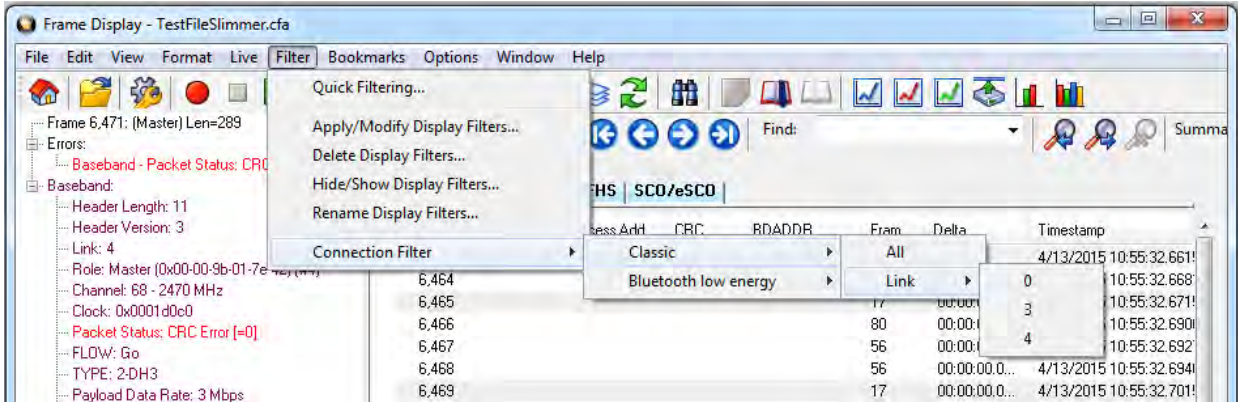

Figure 4.32 - Connection Filter from the Frame Display Menu

From the Frame Display toolbar

Right-click anywhere in the toolbar and select **Connection Filter** from the pop-up menu. The procedure for creating a connection filter are identical as described in **From the Frame Display Filter menu**, above.



Figure 4.33 - Connection Filter from the Frame Display Toolbar right-click

From the Frame Display panes

Right-click anywhere in a Frame Display pane and select **Connection Filter** in the pop-up menu. The procedure for creating a connection filter are identical as described in **From the Frame Display Filter menu**, above.

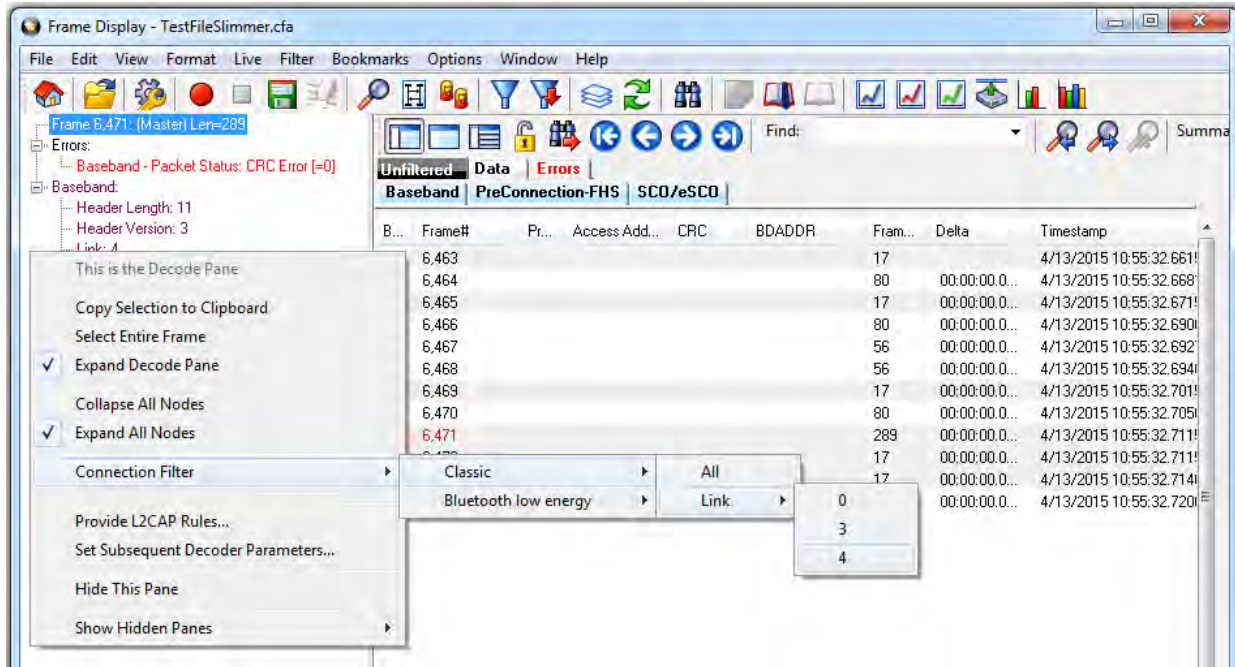

Figure 4.34 - Connection Filter from the Frame Display Pane right-click

From the Frame Display frame selection

Select a frame in the summary pane. Right-click and select **Connection Filter** in the pop-up menu. The procedure for creating a connection filter are identical as described in **From the Frame Display Filter menu**, above.

If the frame you have selected is associated with a Classic *Bluetooth* link or a *Bluetooth* low energy access address, an additional pop-up menu item will appear as shown in the example image below. This selection is a predetermined filter based on your selection. In the example, frame "6471" is associated with "Link 4", so the predetermined filter assumes that you may want create a connection filter for that link. Clicking on **Connection Filter Link = 4** will filter in "Link 4" frames without opening all the drop-down menus.

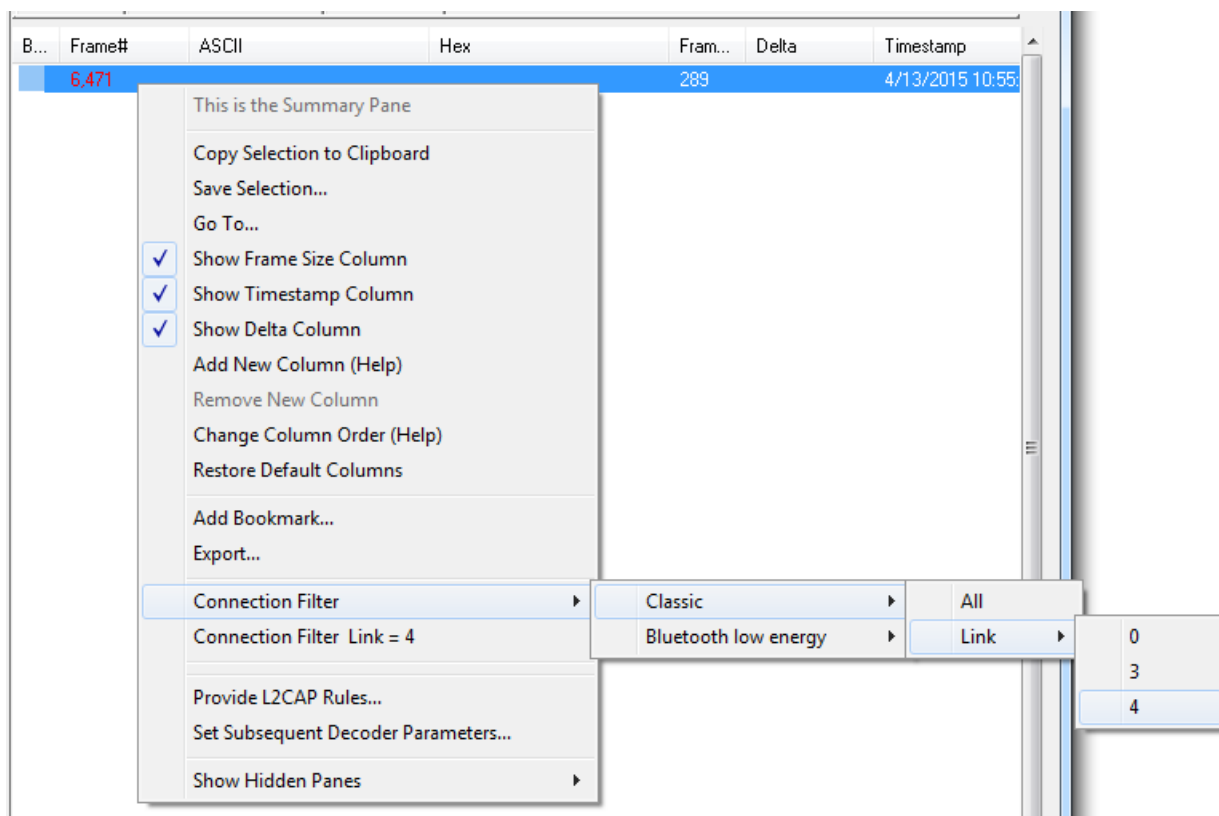



Figure 4.35 - Connection Filter from frame selection right-click

Creating from any Frame Display window

A Connection Filter can be created from any open Frame Display window, and the filtering will always be applied to the original captured data set.

4.3.1.13.2.2 Connection Filter Display

Once you have selected which connections to filter in, another Frame Display will open. The original Frame Display will remain open, and can be minimized.

Note: The system currently limits the number of frame displays to 5. This limit includes any Frame Displays opened using Duplicate View  from the Toolbar (see [Working with Multiple Frame Displays on page 71](#))

The new Frame Display with the filtered connection frames will only contain the data defined by the filter criteria. That is, the criteria could be a single link or data for a particular technology.

Display Example 1: Bluetooth low energy Access Address selected

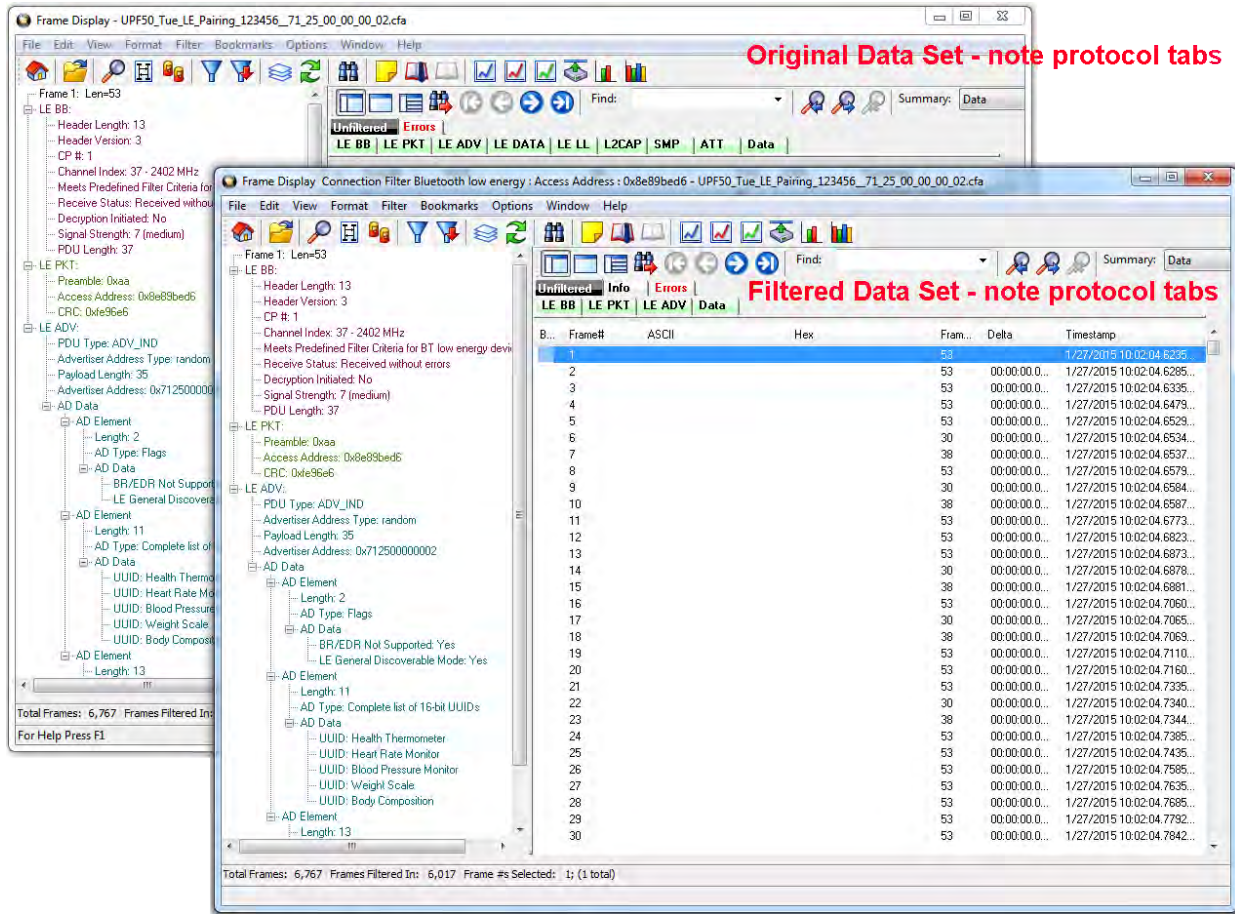

Figure 4.36 - Front Display: Filtered on Access Address 0x8e89bed6

In the figure above is an example Bluetooth low energy data set connection filtered on Access Address = 0x8e89bed6. The Frame Display in the front is the filtered data set. One way to note the difference between the original and the filtered display is to observe the Protocol Tabs. In the filtered display there are four low energy protocol tabs as compared to nine in the original display. This access address connection is not using five of the protocols.

From any open Frame display the user can set another Connection Filter based on the original data set.

Display Example 2: All 802.11 data filtered in

In this example, there is a capture file with Classic Bluetooth, Bluetooth low energy, and 802.11. To view just the 802.11 data set, 802.11 = All is selected from the right-click pop up menu.

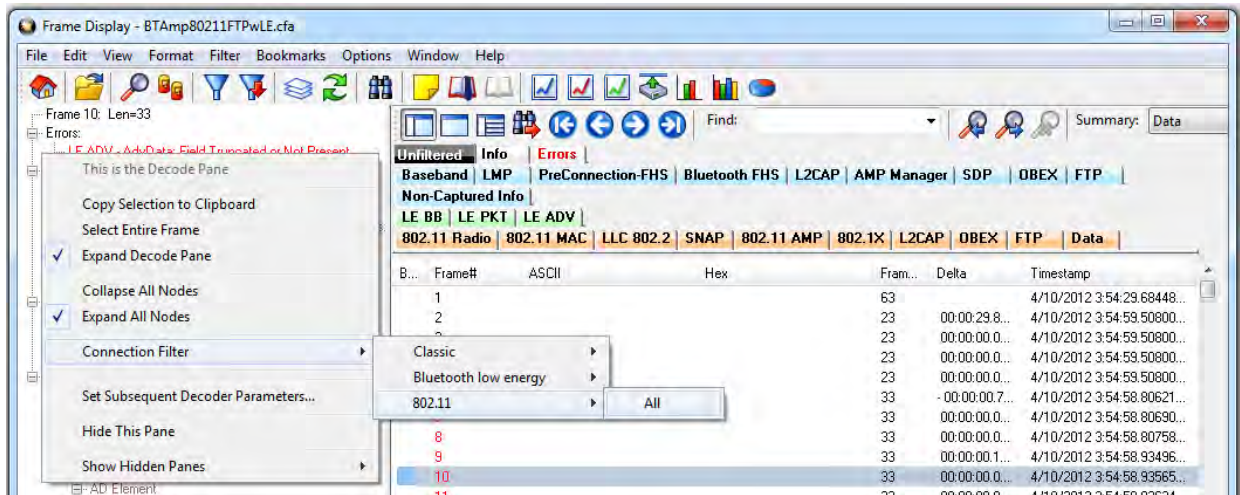

Figure 4.37 - Unfiltered: Capture File with Classic, low energy, and 802.11

When the Frame Display with the filtered 802.11 data set appears, only the Protocol Tabs for 802.11 are present and the tabs for Classic *Bluetooth* and *Bluetooth* low energy have been filtered out.

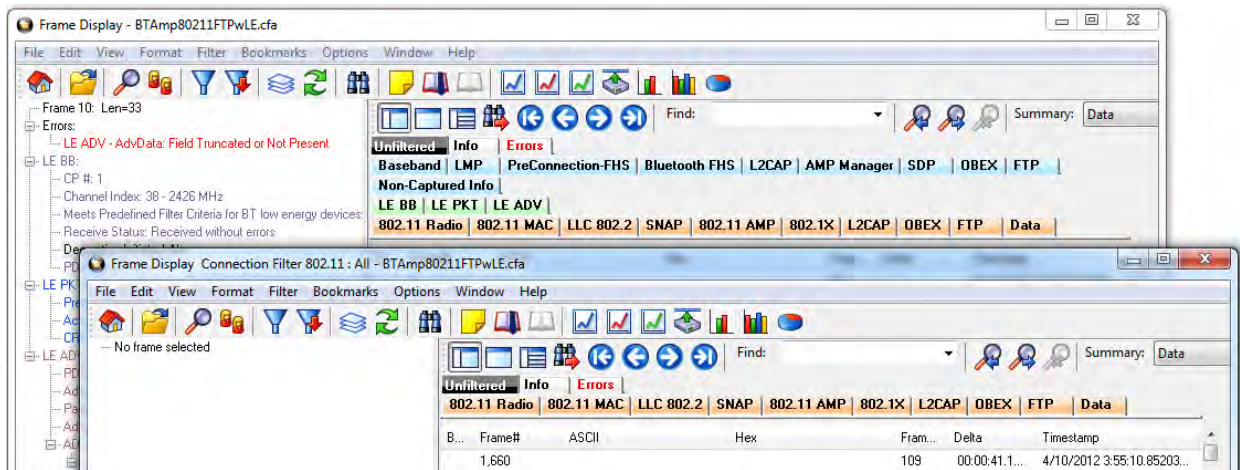

Figure 4.38 - Connection Filter selecting All 802.11 frames, front

4.3.1.13.3 Protocol Filtering from the Frame Display

4.3.1.13.3.1 Quick Filtering on a Protocol Layer

On the **Frame Display**, click the **Quick Filtering** icon  or select **Quick Filtering** from the **Filter** menu.

This opens a dialog that lists all the protocols discovered so far. The protocols displayed change depending on the data received.

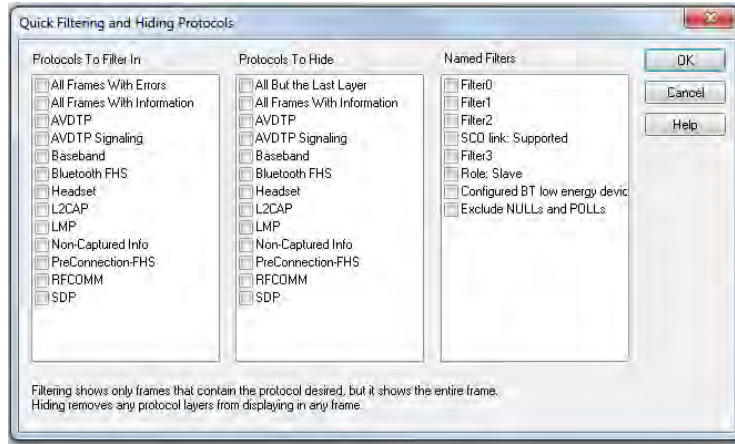

Figure 4.39 - Frame Display Quick Filtering and Hiding Protocols Dialog

The box on the left is **Protocols To Filter In**. When you select the checkbox for a protocol in the **Protocols to Filter In**, the **Summary** pane will only display those frames that contain data from that protocol.

If you filter on more than one protocol, the result are all frames that contain at least one of those protocols. For example, if you filter on IP and IPX NetBIOS, you receive all frames that contain either IP or IPX NetBIOS (or both). A **Quick Filter** tab then appears on the **Frame Display**. Changing the filter definition on the **Quick Filter** dialog changes the filter applied on the **Quick Filter** tab. Quick filters are persistent during the session, but are discarded when the session is closed.



The box in the center is the **Protocols To Hide**. When you select the checkbox for a protocol in the **Protocols To Hide**, data for that protocol will not appear in the **Decode, Binary, Radix, and Character** panes. The frames containing that type data will still appear in the **Summary** pane, but not in the **Decode, Binary, Radix, and Character** panes.

The box on the right is the **Named Filters**. It contains filters that you create using the Named Filter and Set Condition dialogs. When you select the checkbox for the **Name Filters**, a tab appears on the Summary Pane that displays the frame containing the specific data identified in the filter. The named Filter tab remains on the Frame Display Summary Pane unless you hide it using the Hide/Show Display Filters dialog.

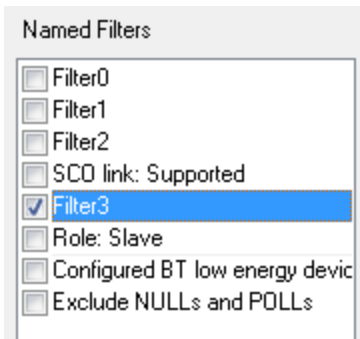

Check the small box next to the name of each protocol you want to filter in, hide, or **Named Filter** to display.

Then click **OK**

4.3.1.13.3.2 Easy Protocol Filtering

There are two types of easy protocol filtering. The first method lets you filter on the protocol shown in the **Summary** pane, and the second lets you filter on any protocol discovered on the network so far.



Filtering on the Summary Layer Protocol

To filter on the protocol in the **Summary** in the **Frame Display** window pane:

1. Select the tab of the desired protocol, or open the **Summary** combo box.
2. Select the desired protocol.
3. To filter on a different layer, just select another tab, or change the layer selection in the combo box.

Filtering on all Frames with Errors

To filter on all frames with errors:

1. Open the **Frame Display**  window.
2. Click the starred **Quick Filter** icon  or select **Quick Filtering** from the **Filter** menu
3. Check the box for **All Frames With Errors** in the **Protocols To Filter In** pane, and click **OK**.
4. The system creates a tab on the **Frame Display** labeled "Errors" that displays the results of the **All Frames With Errors** filter. 

Note: When you have multiple Frame Display windows open and you are capturing data, you may receive an error message declaring that "Filtering cannot be done while receiving data this fast." If this occurs, you may have to stop filtering until the data is captured.

4.3.2 Coexistence View

[\(Click here to see an introduction video...\)](#)

The **Coexistence View** displays Classic *Bluetooth*, *Bluetooth* low energy, and 802.11 packets and throughput in one view. You access the **Coexistence View** by clicking its button  in the **Control** window or **Frame Display** toolbars, or **Coexistence View** from the **View** menus.

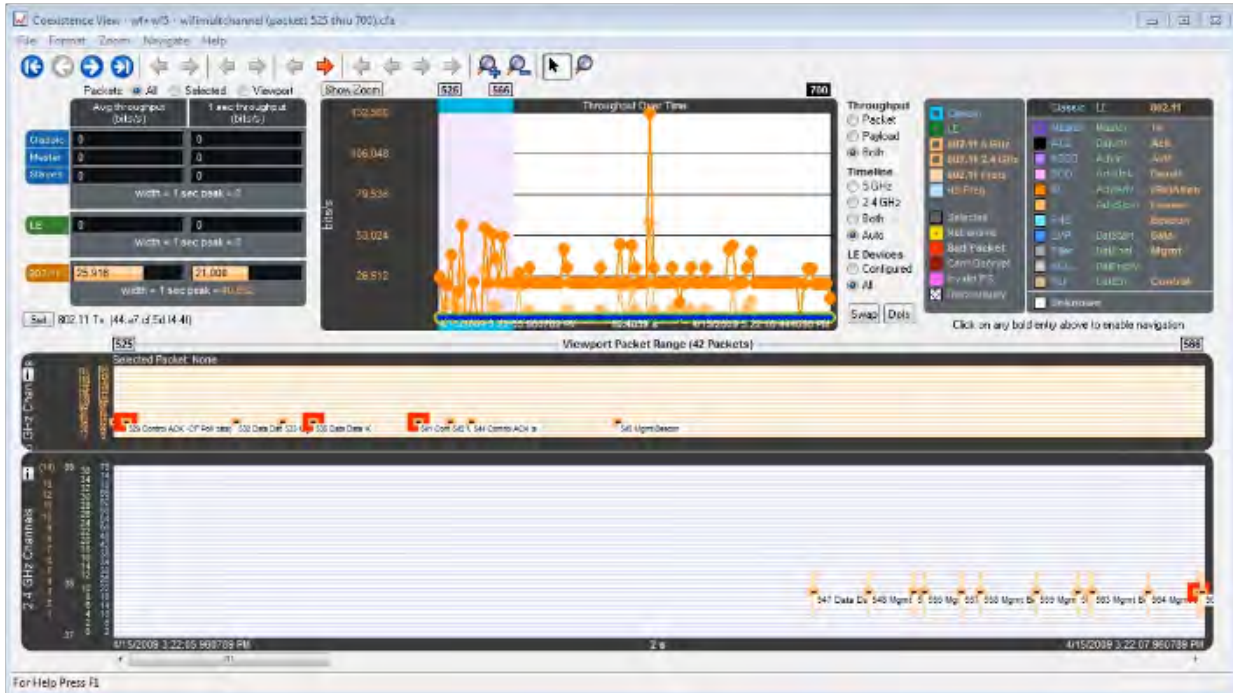
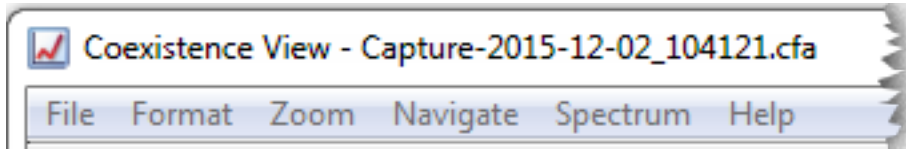

Figure 4.40 - Coexistence View Window

4.3.2.1 Coexistence View Menus



The following tables describe each of the Coexistence View Menus.

Table 4.3 - Coexistence View File Menu Selections

Selection	Description
Reset	Resets the Coexistence View window to its default settings.
Exit	Closes the Coexistence View window.

Table 4.4 - Coexistence View Format Menu Selections

Selection	Description
Show Packet Number	When checked, the packet number shows below the packet in the Viewport. 
Show Packet Type	When checked, the packet type shows below the packet in the Viewport. 

Table 4.4 - Coexistence View Format Menu Selections (continued)

Selection	Description
Show Packet Subtype	When checked, the packet subtype shows below the packet in the Viewport, if applicable.
Hide Packet Text	When checked, hides any text shown below the packet in the Viewport. Applies the text shown by the Show Packet Number, Show Packet Type , and Show Packet Subtype menu selections.
Auto Hide Packet Text When Duration > 31.25 ms.	When checked, automatically hides any text shown below the packet in the Viewport when the Viewport duration exceeds 31.25 ms. Applies the text shown by the Show Packet Number, Show Packet Type , and Show Packet Subtype menu selections. The Viewport duration is shown at the bottom of the Viewport. This selection reduces display clutter when viewing a larger timeline section.
Increase Auto Hide Packet Count from 4,000 to 20,000 (May Be Slow)	When not checked, the default, the packets in the viewport are hidden if the number of visible packets exceeds 4,000. When checked, the default count increased from 4,000 to 20,000 packets before the packets are hidden. Choosing this selection may slow down the displaying of the packets.
<i>The following three selections are mutually exclusive.</i>	
Use All Packets for Throughput Indicators	When checked, all captured packets are used for average throughput calculations and all packets in the last one second of the capture session are used for the 1 sec throughput. See on page 108 for more information. Performs the same function as the throughput indicator All radio button.
Use Selected Packets for Throughput Indicators	When checked, the packets selected in the Viewport are used for average throughput calculations, and selected packets in the one second before the last selected packet are used for the 1 sec throughput. See on page 108 for more information. Performs the same function as the throughput indicator Selected radio button.
Use Viewport Packets for Throughput Indicators	When checked, all packets appearing in the Viewport are used for average throughput calculations, and all packets in the one second before the last packet in the Viewport are used for the 1 sec throughput. See on page 108 for more information. Performs the same function as the throughput indicator Viewport radio button.
Set 802.11 Tx Address	When checked, this selection is used to specify the 802.11 source address, where any packet with that source address is considered a Tx packet and is shown with a purple border in the timelines. Performs the same function as the SET button. Refer to on page 117
<i>The following three selections are mutually exclusive.</i>	
Show Packet Throughput	When checked, the Throughput Graph and Throughput Indicator shows data based on packet throughput. Performs the same function as the Throughput Packet radio button.
Show Payload Throughput	When checked, the Throughput Graph and Throughput Indicator shows data based on payload throughput. Performs the same function as the Throughput Payload radio button.

Table 4.4 - Coexistence View Format Menu Selections (continued)

Selection	Description
Show Both Packet And Payload Throughput	When checked, the Throughput Graph will graph both the data based on packets throughput in darker colors and payload throughput in lighter colors. The Throughput Indicator will show calculations based on packet throughput. Performs the same function as the Throughput Both radio button.
<i>The following four selections are mutually exclusive.</i>	
Show 5 GHz Timeline	When checked, the 5 GHz Timeline is visible and the 2.4 GHz Timeline is not visible. Only 802.11 5 GHz packets are shown. Performs the same function as the Timeline 5 GHz radio button.
Show 2.4 GHz Timeline	When checked, the 2.4 GHz Timeline is visible and the 5 GHz Timeline is not visible. The timeline will show Classic Bluetooth, Bluetooth Low Energy, and 802.11 2.4 GHz packets. Performs the same function as the Timeline 2.4 GHz radio button.
Show Both 2.4 GHz and 5 GHz Timelines	When checked, the 2.4 GHz Timeline and the 5GHz Timeline is visible. Performs the same function as the Timeline Both radio button.
Show Timelines Which Have or Had Packets (Auto Mode)	When check, shows only timelines which have had packets at some point during this session. If no packets are present, the 2.4 GHz Timeline is visible. Performs the same function as the Timeline Auto radio button.
<i>The following two selections are mutually exclusive.</i>	
Show Low Energy Packets From Configured Devices Only	When checked, shows in the 2.4 GHz Timeline only packets from <i>Bluetooth</i> low energy devices configured for this session, and uses these packets for throughput calculations. Performs the same function as the LE Devices Configured radio button.
Show All Low Energy Packets	When checked, shows in the 2.4 GHz Timeline all Bluetooth low energy packets captured in this session, and uses these packets for throughput calculations. Performs the same function as the LE Devices All radio button.
Large Throughput Graph	<p>When checked, the Throughput Graph appears in the bottom half of the window, swapping position with the timeline.</p> <p>When not checked, the Throughput Graph appears in its default position at the top of the window.</p> <p>Performs the same function as clicking the Swap button. See on page 112.</p>

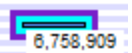
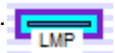
Table 4.4 - Coexistence View Format Menu Selections (continued)

Selection	Description
Show Dots in Throughput Graph (Dots Reveal Overlapped Data Points)	When checked, displays dots on the Throughput Graph. Dots are different sizes for each technology so that they reveal overlapping data points which otherwise wouldn't be visible. A tooltip can be displayed for each dot. Performs the same function as the Dots button. See on page 113 .
Show Zoomed Throughput Graph	When checked, displays a Zoomed Throughput Graph above the Throughput Graph. The Zoomed Throughput Graph shows the details of the throughput in the time range covered by the viewport in the Throughput Graph. Performs the same function as the Show Zoom button. When not checked, the Zoomed Throughput Graph is hidden. Performs the same function as the Hide Zoom button. See on page 114 .
Freeze Y Scales in Zoom Throughput Graph	Only active when the Zoomed Throughput Graph is visible. When checked, it freezes the y-axis scales and makes it possible to compare all time ranges and durations. Performs the same function as the Freeze Y button, which appears with the Zoomed Throughput Graph. When not checked, the y-axis scales are unfrozen. Performs the same function as the Unfreeze Y button, which appears with the Zoomed Throughput Graph. See on page 114 .
Show Tooltips in Upper-Left Corner of Screen	When checked, Timeline and Throughput Graph tooltips will appear in the upper-left corner of your computer screen. You can relocate the tool tip for convenience or to see the timeline or throughput graph unobstructed while displaying packet information. See on page 122 .

Table 4.5 - Coexistence View Zoom Menu Selections

Selection	Description	Hot Key
Zoom In	When clicked, Viewport time duration decreased.	Ctrl+Plus
Zoom Out	When clicked, Viewport time duration increases	Ctrl+Minus
<i>The following two selections are mutually exclusive.</i>		
Scroll Tool (Mouse Wheel Scrolls - Ctrl Key Switches to Zoom Tool)	When checked, sets the mouse wheel to scroll the Viewport. Pressing the Ctrl key while scrolling switches to zooming the Viewport.	

Table 4.5 - Coexistence View Zoom Menu Selections (continued)

Selection	Description	Hot Key
Zoom Tool (Mouse Wheel Zooms- Ctrl Key Switches to Scroll Tool)	When checked, sets the mouse wheel to zoom the Viewport. Pressing the Ctrl key while zooming switches to scrolling the Viewport.	
Zoom To Time Range of Selected Packets	Active only when packets are selected. When clicked, the Viewport duration changes to the time range covered by the selected packets.	
Zoom To Throughput Graph Data Point	When clicked, the Viewport duration changes to the time range of the Throughput Graph selected data point.	
Custom Zoom (Set by Zoom To Time Range of Selected Packets, Zoom To Throughput Graph Data Point, or dragging Viewport Slide)	Automatically checked when taking any zoom action other than the fixed Viewport zoom durations listed below.	

Table 4.5 - Coexistence View Zoom Menu Selections (continued)

Selection	Description	Hot Key
<i>The following 21 selections are mutually exclusive.</i>		
150 usec	Each of these Zoom selections sets the Viewport and the Timeline to a fixed time duration.	
300 usec		
625 usec (1 Bluetooth slot)		
1.25 msec (2 Bluetooth slots)		
1.875 msec (3 Bluetooth slots)		
2.5 msec (4 Bluetooth slots)		
3.125 msec (5 Bluetooth slots)		
6.25 msec (10 Bluetooth slots)		
15.625 msec (25 Bluetooth slots)		
31.25 msec (30 Bluetooth slots)		
62.5 msec (100 Bluetooth slots)		
156.255 msec (250 Bluetooth slots)		
31.25 msec (500 Bluetooth slots)		
625 msec (1,000 Bluetooth slots)		
1 sec (1,600 Bluetooth slots)		
2 sec (3,200 Bluetooth slots)		
3 sec (4,800 Bluetooth slots)		
4 sec (6,400 Bluetooth slots)		
5 sec (8,000 Bluetooth slots)		
10 sec (16,000 Bluetooth slots)		
20 sec (32,000 Bluetooth slots)		

Note: Right-clicking anywhere in the **Coexistence View** window will open the **Zoom** menu in a pop-up.

Table 4.6 - Coexistence View Navigate Menu Selections















Selection	Description	Hot key
First Packet	When clicked, the first packet in the session is selected and displayed in the Timeline. Performs the same function as the  First Packet button.	Home
Last Packet	When clicked, the last packet in the session is selected and displayed in the Timeline. Performs the same function as the  Last Packet button.	End
Previous Packet	When clicked, the first packet occurring in time prior to the currently selected packet is selected and displayed in the Timeline. Performs the same function as the  Previous Packet button.	Left Arrow
Next Packet	When clicked, the first packet occurring next in time from the currently selected packet is selected and displayed in the Timeline. Performs the same function as the  Next Packet button.	Right Arrow
Previous Retransmitted Packet	When clicked, selects the first prior retransmitted packet from the current selection and displays it in the Timeline.. Performs the same function as the  Previous Retransmitted Packet button.	
Next Retransmitted Packet	When clicked, selects the next retransmitted packet from the current selection and displays it in the Timeline.. Performs the same function as the  Next Retransmitted Packet.	
Previous Invalid IFS Packet	When clicked, selects the first prior invalid <i>Bluetooth</i> low energy IFS packet from the current selection and displays it in the Timeline. Performs the same function as the  Previous Invalid IFS Packet button.	
Next Invalid IFS Packet	When clicked, selects the next invalid <i>Bluetooth</i> low energy IFS packet from the current selection and displays it in the Timeline. Performs the same function as the  Next Invalid IFS Packet button.	
Previous Error Packet	When clicked, selects the first prior packet with an error from the current selection and displays it in the Timeline. Performs the same function as the  Previous Error Packet button.	Ctrl+Left Arrow

Table 4.6 - Coexistence View Navigate Menu Selections (continued)

Selection	Description	Hot key
Next Error Packet	When clicked, selects the next packet with an error from the current selection and displays it in the Timeline. Performs the same function as the  Next Error Packet button.	Ctrl+Right Arrow
First Legend Packet	When clicked, selects the first legend packet in the session and displays it in the Timeline. This control is enabled when a bold packet type is selected in the Coexistence View Legend. Refer to on page 119 . Performs the same functions as the  First Legend Packet button.	
Previous Legend Packet	When clicked, selects the first prior legend packet in time from the current selection and displays it in the Timeline. This control is enabled when a bold packet type is selected in the Coexistence View Legend. Refer to on page 119 . Performs the same functions as the  Previous Legend Packet button.	
Next Legend Packet	When clicked, selects the next legend packet in time from the current selection and displays it in the Timeline. This control is enabled when a bold packet type is selected in the Coexistence View Legend. Refer to on page 119 . Performs the same functions as the  Next Legend Packet button.	
Last Legend Packet	When clicked, selects the last legend packet in the session and displays it in the Timeline. This control is enabled when a bold packet type is selected in the Coexistence View Legend. Refer to on page 119 . Performs the same functions as the  Last Legend Packet button.	
Toggle Display Lock	This selection is active during Live capture mode only. Checking this selection will lock the Throughput Graph and the Timeline in its current position, however the capture will continue. Not checking this selection will cause the Throughput Graph and the Timeline to scroll as data is collected.	

Note: **Navigate** menu selections are context sensitive. For example, If the first packet is selected, the **Next Packet** and the **Last Packet** selections are active, but the **Previous Packet** selection is inactive.

4.3.2.2 Coexistence View - Toolbar







Figure 4.41 - Coexistence View Toolbar

The toolbar contains the following selections:

Table 4.7 - Coexistence View Toolbar icons

Icon	Description
	Move to the first packet.
	Move to the previous packet.
	Move to the next packet.
	Move to the last packet.
	Move to the previous retransmitted packet.
	Move to the next retransmitted packet
	Move to the previous invalid IFS for <i>Bluetooth</i> low energy.
	Move to the next invalid IFS for <i>Bluetooth</i> low energy.
	Move to the previous bad packet.
	Move to the next bad packet.
	Move to the first packet of the type selected in the legend.
	Move to the previous packet of the type selected in the legend
	Move to the next packet of the type selected in the legend.
	Move to the last packet of the type selected in the legend.
	Zoom in.
	Zoom out.
	Scroll cursor.

Table 4.7 - Coexistence View Toolbar icons (continued)

Icon	Description
	When selected the cursor changes from Scroll  to a context-aware zooming cursor. Click on normal cursor to remove the zooming cursor.
	Zooming cursor.
	Scroll Lock/Unlock during live capture mode.
	Reset during live capture mode. Clears the display.

4.3.2.3 Coexistence View - Throughput Indicators

(Click here to see a video on the Throughput Indicators...)
Throughput Indicators

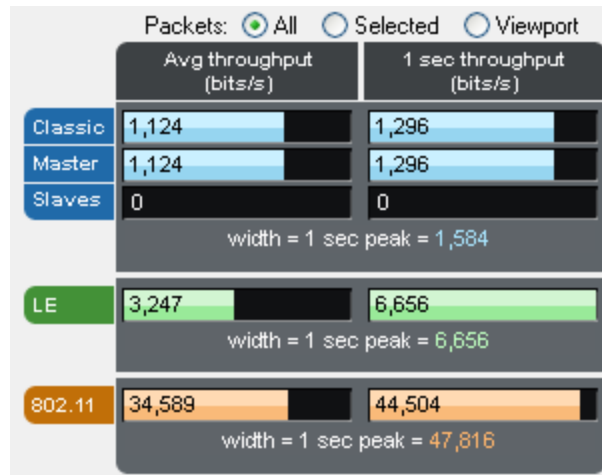

Figure 4.42 - Coexistence View Throughput Indicators

Throughput indicators show average throughput and 1 second throughput for Classic Bluetooth® (all devices, master devices, and slave devices are each shown separately), *Bluetooth* low energy, and 802.11.

4.3.2.4 Throughput

Throughput

- Packet
- Payload
- Both

Throughput is total packet or payload size in bits of the included packets divided by the duration of the included packets, where:

- *Packet size* is used if the Packet or Both radio button is selected in the [Throughput group](#).
- *Payload size* is used if the Payload radio button is selected in the [Throughput group](#).
- [Included packets](#) are defined separately for each of the radio buttons that appear above the throughput indicators.
- *Duration of the included packets* is measured from the beginning of the first included packet to the end of the last included packet.

4.3.2.5 Radio Buttons

Packets: All Selected Viewport The radio buttons above the throughput indicators specify which packets are *included*. Radio button descriptions are modified per the following:

- *Bluetooth* low energy packets from non-configured devices are excluded if the **Configured** radio button in the [LE Devices](#) group is selected.
- **Frame Display** filtering has no effect here in that packets that are filtered-out in **Frame Display** are still used here as long as they otherwise meet the criteria for each radio button as described below.



4.3.2.6 All radio button

Packets: All Selected Viewport **All** packets are used for average throughput, and packets occurring in the last 1 second of the session are used for 1 second throughput, except that *Bluetooth* low energy packets from non-configured devices can be excluded as noted above.

4.3.2.7 Selected radio button

Packets: All Selected Viewport **Selected** packets (the selected packet range is shown in the timeline header) are used for average throughput, and packets in the 1 second duration ending at the end of the last selected packet are used for 1 second, except that *Bluetooth* low energy packets from non-configured devices can be excluded as noted above.

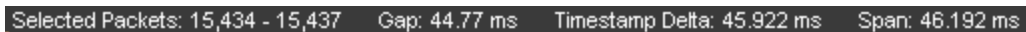

Figure 4.43 - Timeline Header Showing Selected Packets

4.3.2.8 Viewport radio button

Packets: All Selected Viewport The viewport is the purple rectangle in the **Throughput Graph** and indicates a specific starting time, ending time, and resulting duration. Packets that occur within that range of time are used for average throughput, and packets in the 1 second duration ending at the end of the last packet in the viewport time range are used for 1 second throughput, except that *Bluetooth* low energy packets from non-configured devices can be excluded as noted above.

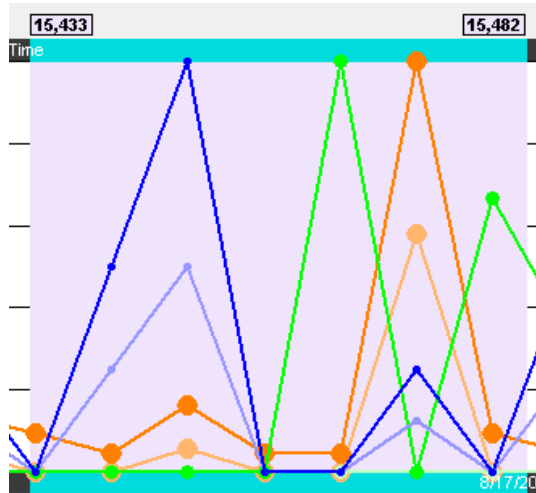

Figure 4.44 - Throughput Graph viewport.

4.3.2.9 Indicator width

The width of each indicator is the largest 1 second throughput seen up to that point for that technology (Classic Bluetooth, Bluetooth low energy, or 802.11), where the 1 second throughput is calculated anew each time another packet is received. The 1 second throughput indicator will never exceed this width, but the average throughput indicator can. For example, the image below has a large average throughput because the Selected radio button was selected and a single packet was selected, and the duration in that case is the duration of the single packet, which makes for a very small denominator in the throughput calculation. When the average throughput exceeds the indicator width, a plus sign (+) is drawn at the right end of the indicator.

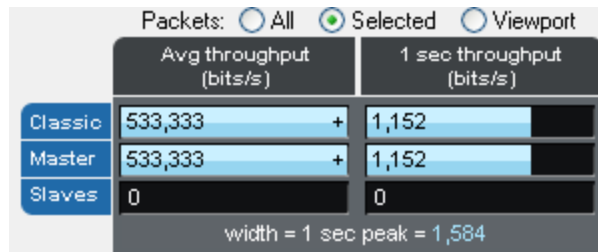

Figure 4.45 - Average throughput indicators show a plus sign (+) when the indicator width is exceeded.



Figure 4.46 - A single selected packet

[\(Click here to see a video on how the Throughput is calculated...\)](#)

4.3.2.10 Coexistence View - Throughput Graph

[\(Click here to see aThroughput Graph video...\)](#)



Figure 4.47 - Coexistence View Throughput Graph

The **Throughput Graph** is a line graph that shows packet and/or payload throughput over time as specified by the radio buttons in the [Throughput group](#). If the **Both** radio button is selected, packet and payload throughput are shown as two separate lines for each technology. The payload throughput line is always below the packet throughput line (unless both are 0).

The data lines and y-axis labels are color-coded: Blue = Classic *Bluetooth*, Green = *Bluetooth* low energy, Orange = 802.11. Each data point represents a duration which is initially 0.1 s. Each time the number of data points per line reaches 300, the number of data points per line is halved to 150 and the duration per data point is doubled. The duration per data point thus progresses from 0.1 s to 0.2 s to 0.4 s to 0.8 s and so on.

4.3.2.11 Throughput Graph Y-axis labels

The y-axis labels show the throughput in bits per second. From left-to-right the labels are for 802.11, *Bluetooth* low energy, and Classic *Bluetooth*. The duration of each data point must be taken into account for the y-axis label's value to be meaningful. For example, if a data point has a duration of 0.1 s and a bit count of 100, it will have a throughput of 1,000 bits/s, and the y-axis labels will be consistent with this.

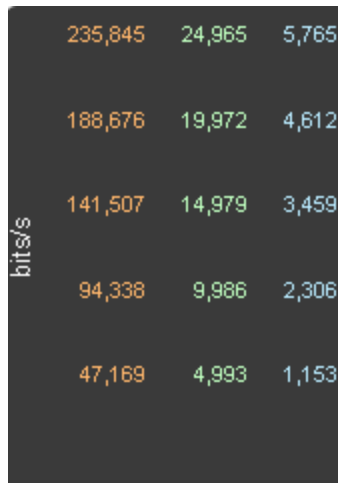

Figure 4.48 - Throughput Graph y-axis labels.

4.3.2.12 Excluded packets

Retransmitted packets and bad packets (packets with CRC or Header errors) are excluded from throughput calculations.

4.3.2.13 Tooltips

Placing the mouse pointer on a data point shows a tooltip for that data point. The tooltip first line shows the throughput, the throughput type (packet or payload), and the technology. Subsequent lines show the bit count, the duration of the data point, the packet range of that duration (only packets of the applicable technology from that packet range are used for the throughput calculation), and the number of the data point (which is 0 for the first data point in each line).

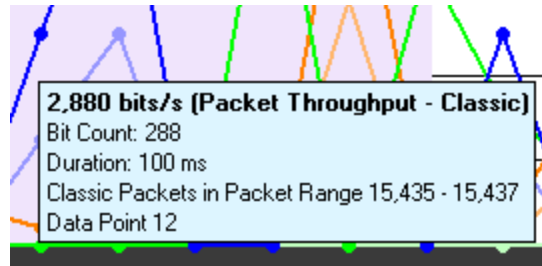

Figure 4.49 - Data point tooltip

The Throughput graph tool tips can be shown in the upper-left corner of your computer screen to provide an unobstructed view. Refer to [Relocating Tool Tips](#).

4.3.2.14 Discontinuities

A discontinuity is when the timestamp going from one packet to the next either goes backward by any amount or forward by more than 4.01 s. This value is used because the largest possible connection interval in *Bluetooth* low energy is 4.0 s. A discontinuity is drawn as a vertical dashed line. A discontinuity for a timestamp going backward is called a negative discontinuity and is shown in red. A discontinuity for a timestamp going forward by more than 4.01 s is called a positive discontinuity and is shown in black. A positive discontinuity is a cosmetic nicety to avoid lots of empty space. A negative discontinuity is an error.

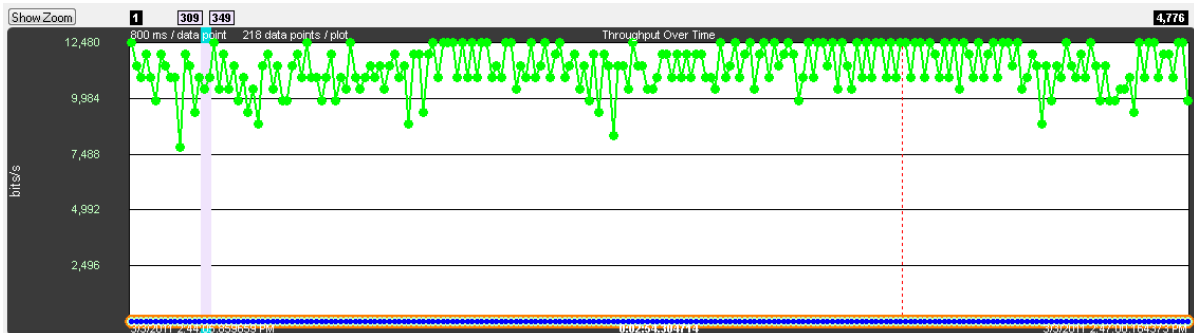

Figure 4.50 - A negative discontinuity.

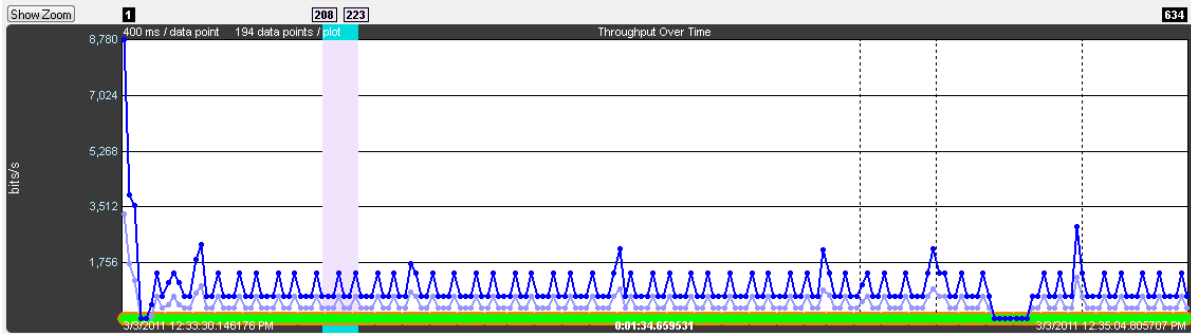

Figure 4.51 - Three positive discontinuities.

4.3.2.15 Viewport

The viewport is the purple rectangle in the **Throughput Graph**. It indicates a specific starting time, ending time, and resulting duration, and is precisely the time range used by the **Timeline**. The packet range that occurs within this time range is shown above the sides of the viewport.

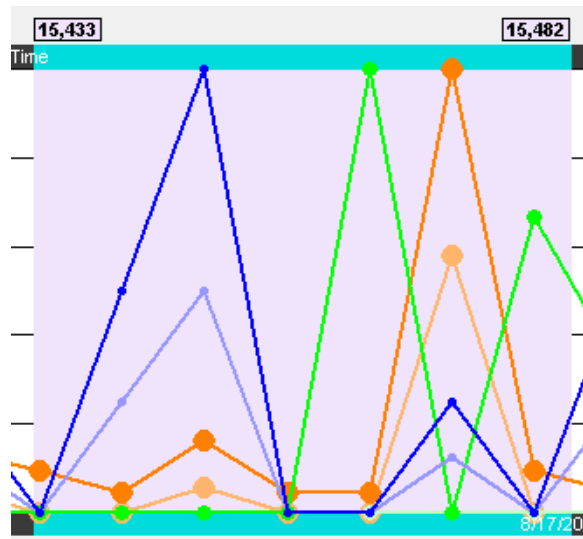



Figure 4.52 - **Throughput Graph** Viewport

The viewport is moved by dragging it or by clicking on the desired location in the **Throughput Graph** (the viewport will be centered at the click point).

The viewport is sized by dragging one of its sides or by using one of the other zooming techniques. See the [Zooming](#) subsection in the **Timeline** section for a complete list.

4.3.2.16 Swap button

The **Throughput Graph** and **Timeline** can be made to trade positions by clicking the **Swap** button.

Clicking the Swap  button swaps the positions of the **Throughput Graphs** and the **Timelines**.

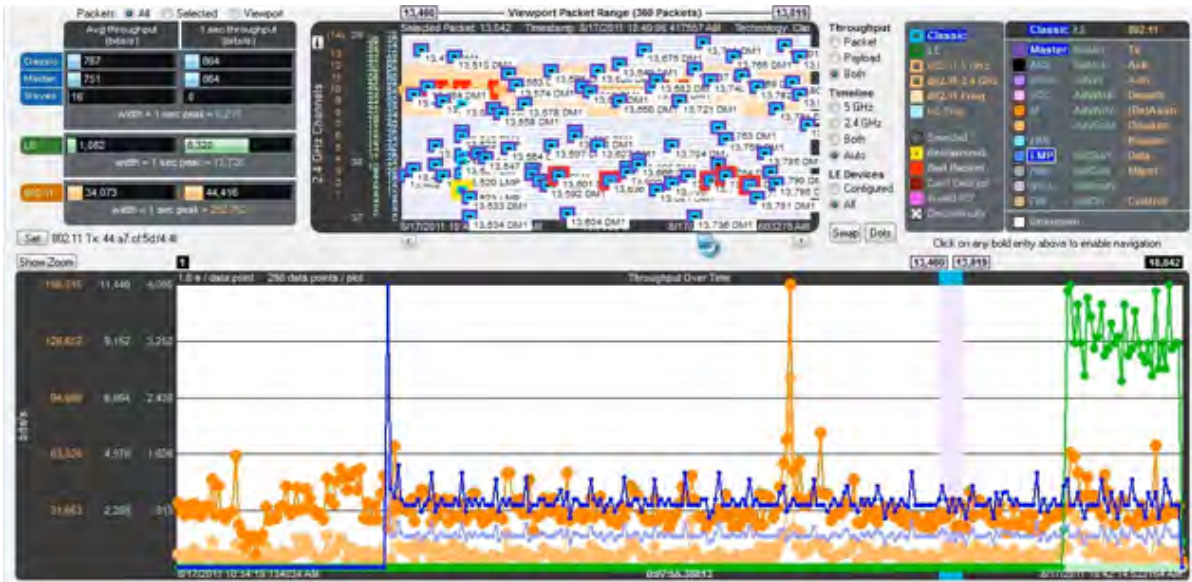



Figure 4.53 - Small Timeline and large Throughput Graph after pressing the Swap button.

4.3.2.17 Dots button

The dots on the data points can be toggled on and off by clicking the **Dots**  button. Dots are different sizes for each technology so that they reveal overlapping data points which otherwise wouldn't be visible. A tooltip can be displayed for each dot.

Dots can be removed for greater visibility of the plots when data points are crowded together.

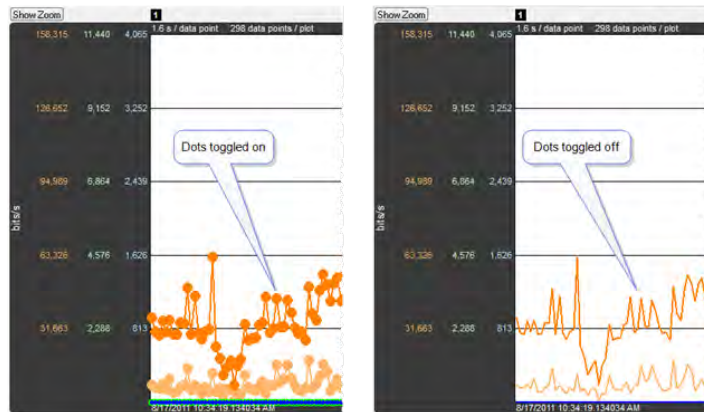

Figure 4.54 - Dots Toggled On and Off

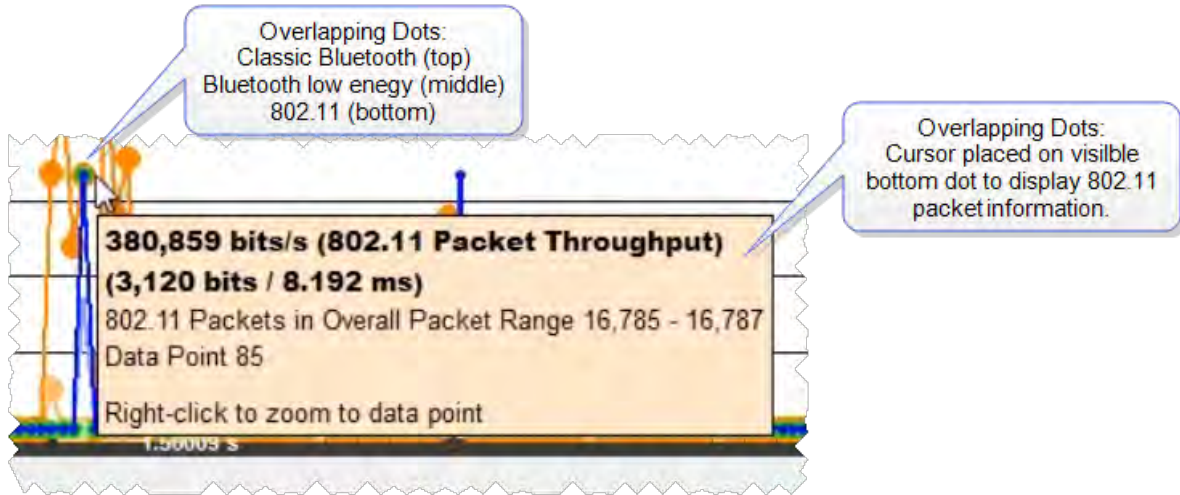

Figure 4.55 - Overlapping **Dots** Information Display

4.3.2.18 Zoomed Throughput Graph

Clicking the **Show Zoom** button displays the **Zoomed Throughput Graph** above the **Throughput Graph**. The **Zoomed Throughput Graph** shows the details of the throughput in the time range covered by the viewport in the **Throughput Graph**. Both the **Zoomed Throughput Graph** and the **Timelines** are synchronized with the **Throughput Graph**'s viewport. The viewport is sized by dragging one of its sides or by using one of the other zooming techniques listed in the [Zooming](#) subsection in the **Timelines** section.

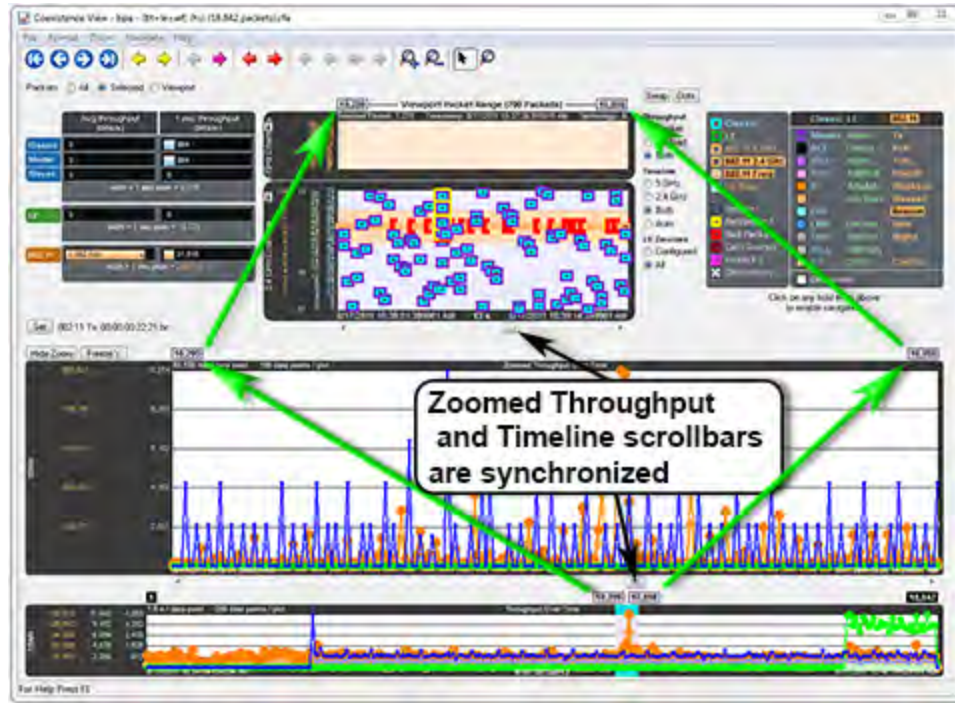

Figure 4.56 - Synchronized Zoomed Throughput Graph and View Port

The largest value in each technology in the **Zoomed Throughput Graph** is snapped to the top of the graph. This makes the graph easier to read by using all of the available space, but because the y-axis scales can change it can make it difficult to compare different time ranges or durations. Clicking the **Freeze Y** button freezes the y-axis scales and makes it possible to compare all time ranges and durations (the name of the button changes to **Unfreeze Y** and a **Y Scales Frozen** indicator appears to the right of the title. Clicking the **Unfreeze Y** button unfreezes the y-axis scales.

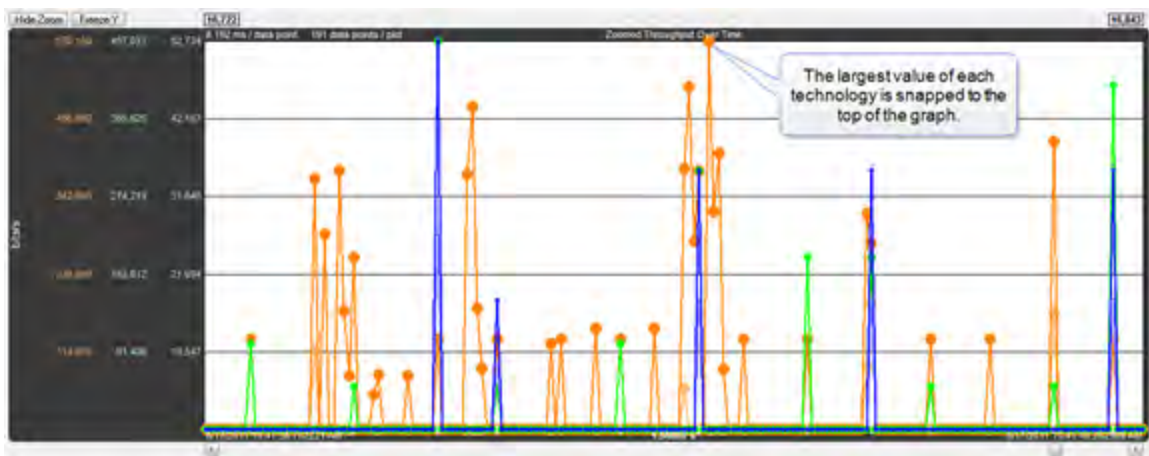

Figure 4.57 - **Zoomed Throughput Graph**- Largest Value Snaps to Top

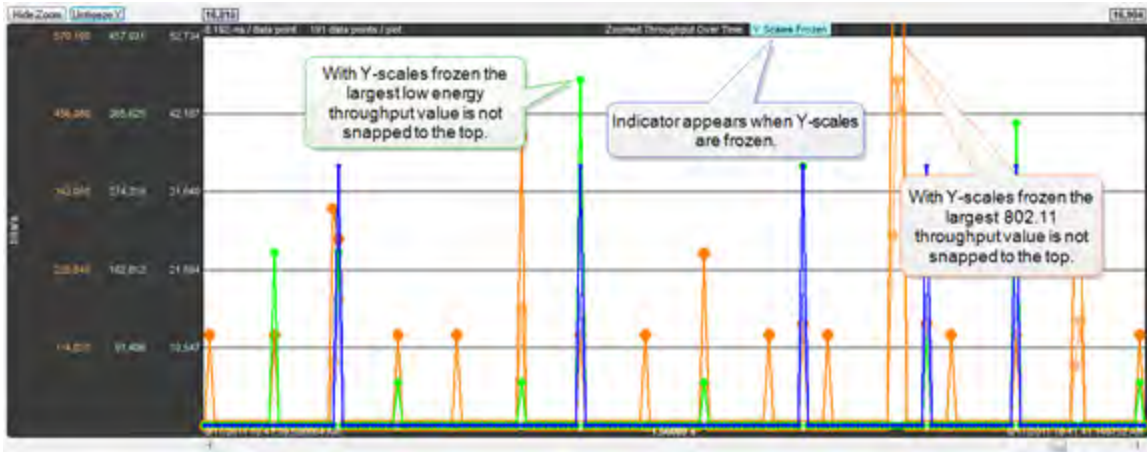
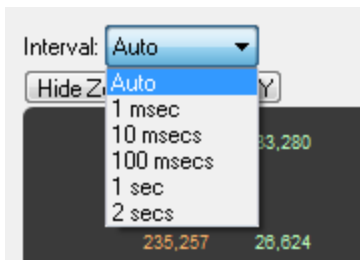



Figure 4.58 - **Zoomed Throughput Graph - Freeze Y** keeps the y-axis constant

Interval Menu



The **Interval** drop-down menu is used to set the duration of each data point in the Zoomed Throughput graph. The default setting is **Auto** that sets the data point interval automatically depending on the zoom level. The other menu selections provide the ability to select a fixed data point interval. Selecting from a larger to a smaller interval will display more data points. Should the number of data points exceed 30,000, no data is displayed and a warning will appear in the graph area.

4.3.2.19 Zoom Cursor

Selecting the **Zoom Cursor**  button changes the cursor to the zoom cursor . The zoom cursor is controlled by the mouse wheel and zooms the viewport and thus the [Timelines](#) and the [Zoomed Throughput Graph](#). The zoom cursor appears everywhere except the **Throughput Graph**, which is not zoomable, in which case the scroll cursor is shown. When the zoom cursor is in the **Timelines** or **Zoomed Throughput Graph** zooming occurs around the point in time where the zoom cursor is positioned. When the zoom cursor is outside the **Timelines** and the **Zoomed Throughput Graph** the left edge of those displays is the zoom point.

4.3.2.20 Comparison with the *Bluetooth* Timeline's Throughput Graph

The **Throughput Graphs** for Classic *Bluetooth* in the **Coexistence View** and the *Bluetooth* **Timeline** can look quite different even though they are plotting the same data. The reason is that the **Coexistence View** uses timestamps while the *Bluetooth* **Timeline** uses *Bluetooth* clocks, and they do not always match up exactly. This mismatch can result in the data for a particular packet being included in different intervals in the two **Throughput Graphs**, and can have a significant impact on the shapes of the two respective graphs. This can also result in the total duration of the two **Throughput Graphs** being different.

Another factor that can affect total duration is that the *Bluetooth Timeline's Throughput Graph* stops at the last Classic *Bluetooth* packet while the **Coexistence View's Throughput Graph** stops at the last packet regardless of technology.

4.3.2.21 Coexistence View - Set Button

([Click here to see a video on the Wi-Fi Tx Address Set button...](#))

802.11 Tx: 00:0c:29:85:f3:31

The **Set** button is used to specify the 802.11 source address, where any packet with that source address is considered a Tx packet and is shown with a purple border in the timelines.

All source MAC addresses that have been seen during this session are listed in the dialog that appears when the **Set** button is clicked. Also listed is the last source MAC address that was set in the dialog in the previous session. If that address has not yet been seen in this session, it is shown in parentheses.

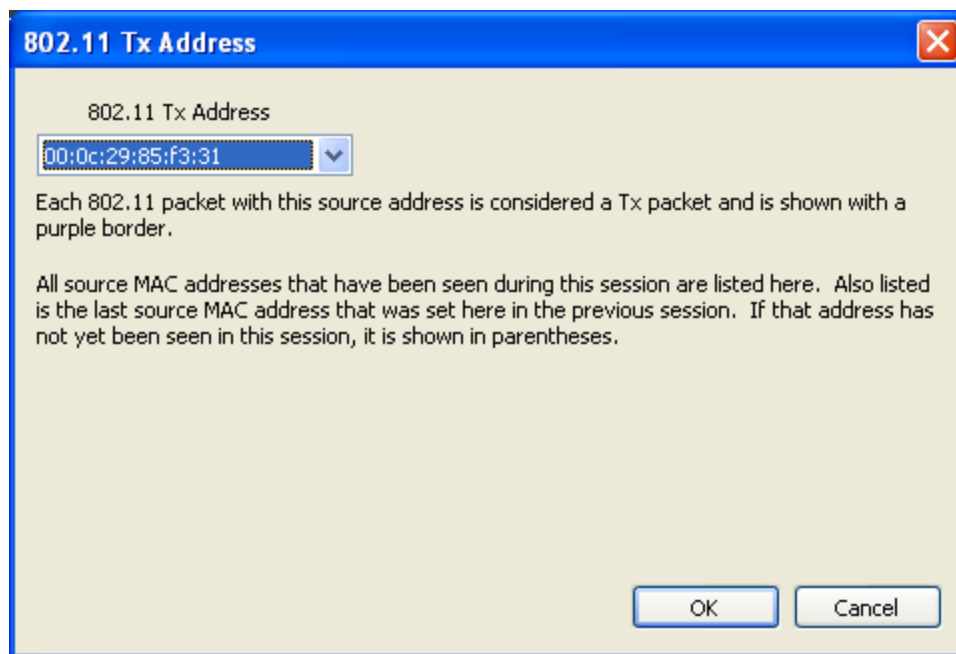

Figure 4.59 - 802.11 Source Address Dialog

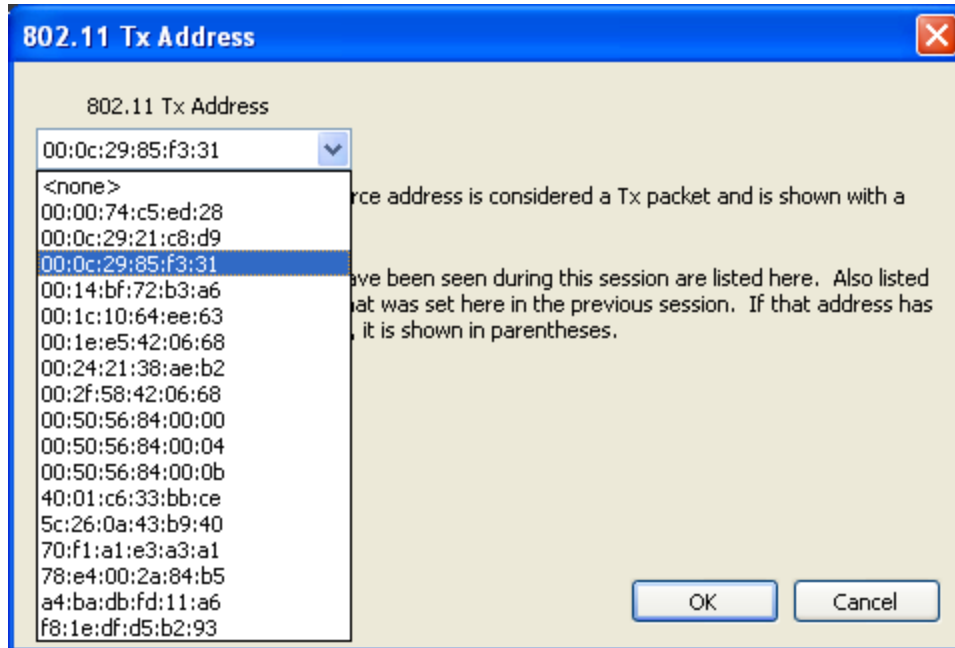

Figure 4.60 - 802.11 Source Address Drop Down Selector

4.3.2.22 Coexistence View - Throughput Radio Buttons

- Throughput**
- Packet
 - Payload
 - Both

The radio buttons in the **Throughput** group specify whether to show packet and/or payload lines in the [Throughput Graph](#), and also whether to show packet or payload throughput in the throughput indicators (if the **Both** radio button is selected, packet throughput is shown in the throughput indicators).

4.3.2.23 Coexistence View - Timeline Radio Buttons

- Timeline**
- 5 GHz
 - 2.4 GHz
 - Both
 - Auto

The radio buttons in the **Timeline** group specify timeline visibility. The first three buttons specify whether to show one or both timelines, while the **Auto** button shows only timelines which have had packets at some point during this session. If no packets have been received at all and the **Auto** button is selected the 2.4 GHz timeline is shown.

4.3.2.24 Coexistence View – low energy Devices Radio Buttons

- LE Devices**
- Configured
 - All

The radio buttons in the **LE Devices** group (where “LE” means Bluetooth® low energy) specify both visibility and inclusion in throughput calculations of *Bluetooth* low energy packets. The **All** radio button shows and uses all *Bluetooth* low energy packets. The **Configured** radio button shows and uses only *Bluetooth* low energy packets which come from a configured device.

4.3.2.25 Coexistence View – Legend

(This video provides more details on the Legend...)

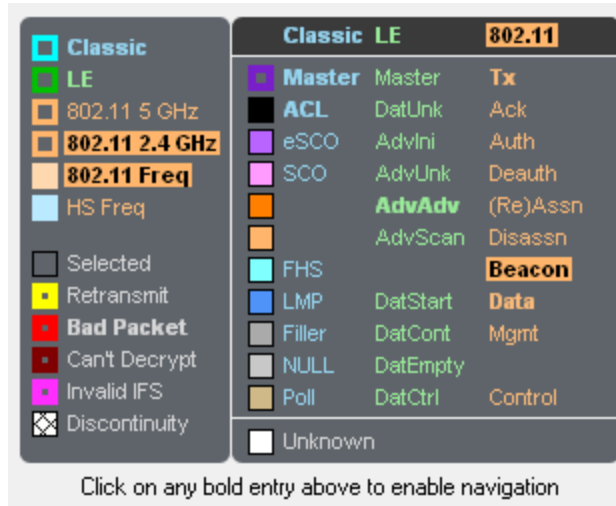

Figure 4.61 - Coexistence View Legend

The legend describes the color-coding used by packets in the timelines. Selecting a packet in a timeline highlights the applicable entries in the legend. An entry is bold if any such packets currently exist. Clicking on a bold entry enables the black legend navigation arrows in the toolbar for that entry.

4.3.2.26 Coexistence View – Timelines

(Click here to see a Coexistence View Timeline video...)

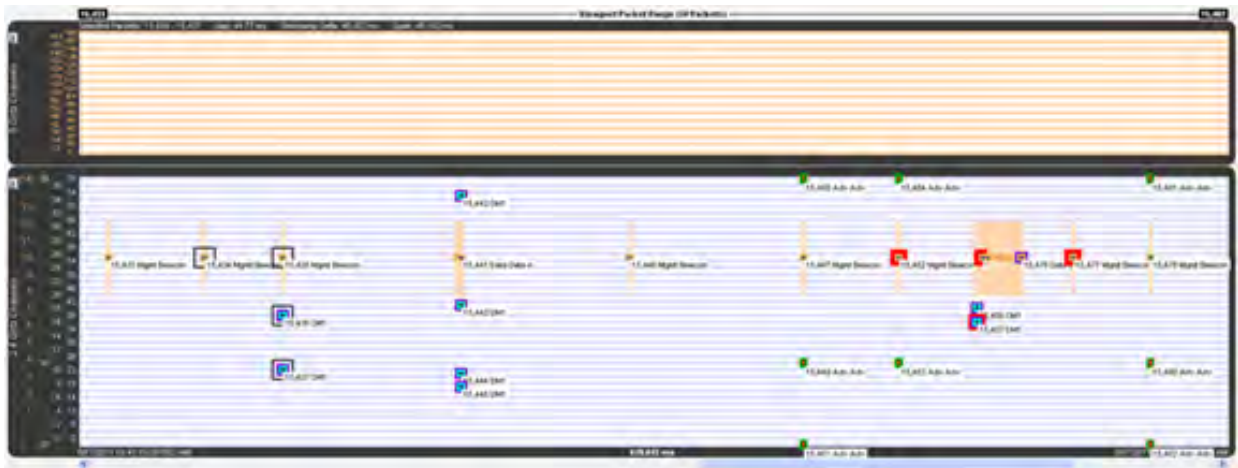

Figure 4.62 - Coexistence View Timelines

The **Timelines** show Classic Bluetooth®, Bluetooth low energy, and 802.11 packets by channel and time.

4.3.2.27 Packet information

Packet information is provided in various ways as described below.

Packets are color-coded to indicate attribute (Retransmit, Bad Packet, Can't Decrypt, or Invalid IFS), master/Tx, technology (Classic Bluetooth®, Bluetooth low energy, or 802.11), and category/type.

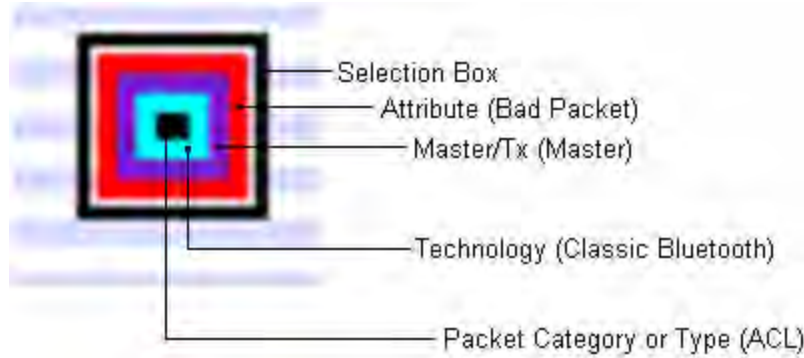

Figure 4.63 - Each packet is color-coded

The innermost box (which indicates packet category/type) is the packet proper in that its vertical position indicates the channel, its length indicates the packet's duration in the air, its left edge indicates the start time, and its right edge indicates the end time.

The height of Classic Bluetooth and Bluetooth low energy packets indicates their frequency range (1 MHz and 2 MHz respectively). Since 802.11 channels are so wide (22 MHz), 802.11 packets are drawn with an arbitrary 1 MHz height and centered within a separate frequency range box which indicates the actual frequency range.

Selecting a packet by clicking on it draws a selection box around it (as shown above) and highlights the applicable entries in the legend.

<input type="checkbox"/> Classic	Classic	<input type="checkbox"/> LE	LE	<input type="checkbox"/> 802.11 5 GHz	802.11	<input type="checkbox"/> 802.11 2.4 GHz	802.11	<input type="checkbox"/> 802.11 Freq	802.11 Freq	<input type="checkbox"/> HS Freq	HS Freq
<input type="checkbox"/> Selected	Selected	<input type="checkbox"/> Retransmit	Retransmit	<input type="checkbox"/> Bad Packet	Bad Packet	<input type="checkbox"/> Can't Decrypt	Can't Decrypt	<input type="checkbox"/> Invalid IFS	Invalid IFS	<input type="checkbox"/> Discontinuity	Discontinuity
<input type="checkbox"/> Master	Master	<input type="checkbox"/> ACL	ACL	<input type="checkbox"/> eSCO	eSCO	<input type="checkbox"/> SCO	SCO	<input type="checkbox"/> AdvAdv	AdvAdv	<input type="checkbox"/> AdvScan	AdvScan
<input type="checkbox"/> FHS	FHS	<input type="checkbox"/> LMP	LMP	<input type="checkbox"/> Filler	Filler	<input type="checkbox"/> NULL	NULL	<input type="checkbox"/> Poll	Poll	<input type="checkbox"/> Unknown	Unknown
<input type="checkbox"/> Master	Master	<input type="checkbox"/> Tx	Tx	<input type="checkbox"/> DatUnk	DatUnk	<input type="checkbox"/> Ack	Ack	<input type="checkbox"/> AdvIni	AdvIni	<input type="checkbox"/> Auth	Auth
<input type="checkbox"/> AdvUnk	AdvUnk	<input type="checkbox"/> Deauth	Deauth	<input type="checkbox"/> (Re)Assn	(Re)Assn	<input type="checkbox"/> Disassn	Disassn	<input type="checkbox"/> Beacon	Beacon	<input type="checkbox"/> Data	Data
<input type="checkbox"/> DatStart	DatStart	<input type="checkbox"/> Mgmt	Mgmt	<input type="checkbox"/> DatCont	DatCont	<input type="checkbox"/> Control	Control				

Click on any bold entry above to enable navigation

Figure 4.64 - Highlighted entries in the legend for a selected packet.

Summary information for a selected packet is displayed in the timeline header.

Selected Packet: 15,457 Timestamp: 8/17/2011 10:41:19.835783 AM Technology: Classic Type: DM1 Bluetooth Clock: 0x0113e610 Payload Len: 9 bytes

Figure 4.65 - **Timeline** header for a single selected packet.

When multiple packets are selected (by dragging the mouse with the left button held down, clicking one packet and shift-clicking another, or clicking one packet and pressing shift-arrow), the header shows **Gap** (duration between the first and last selected packets), **Timestamp Delta** (difference between the timestamps, which are at the beginning of each packet), and **Span** (duration from the beginning of the first selected packet to the end of the last selected packet).

Selected Packets: 15,434 - 15,437 Gap: 44.77 ms Timestamp Delta: 45.922 ms Span: 46.192 ms

Figure 4.66 - **Timeline** header for multiple selected packets

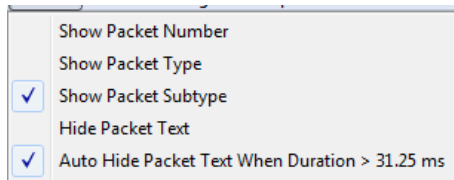

Text can be displayed at each packet by selecting **Show Packet Number**, **Show Packet Type**, and **Show Packet Subtype** from the **Format** menu.

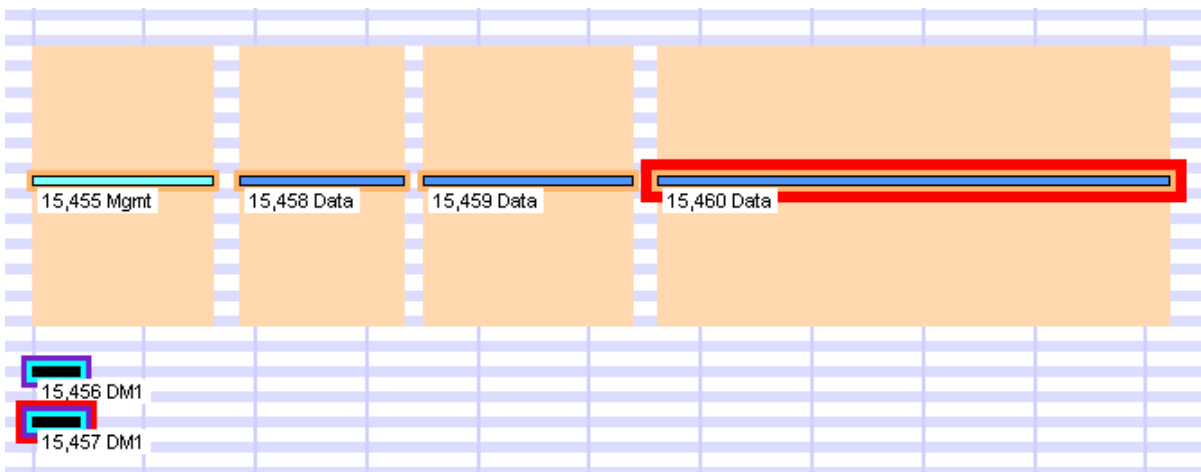

Figure 4.67 - Descriptive text on timeline packets.

Placing the mouse pointer on a packet displays a tooltip (color-coded by technology) that gives detailed information.

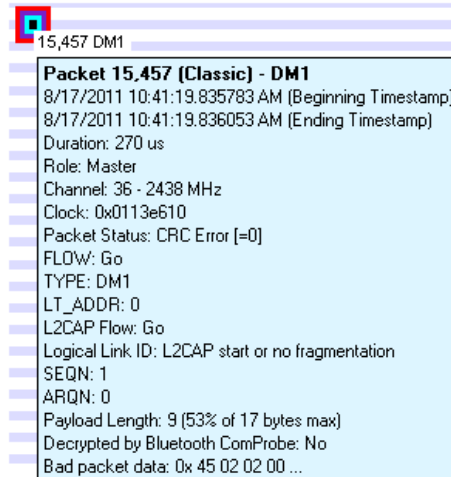

Figure 4.68 - A tool tip for a Classic *Bluetooth* packet.

4.3.2.28 Relocating the tool tip

You can relocate the tool tip for convenience or to see the timeline or throughput graph unobstructed while displaying packet information. In the **Format** menu select **Show Tooltips in Upper-Left Corner of Screen**, and any time you mouse-over a packet the tool tip will appear anchored in the upper-left corner of the computer screen. To return to viewing the tool tip adjacent to the packets deselect the tool tip format option in the menu.

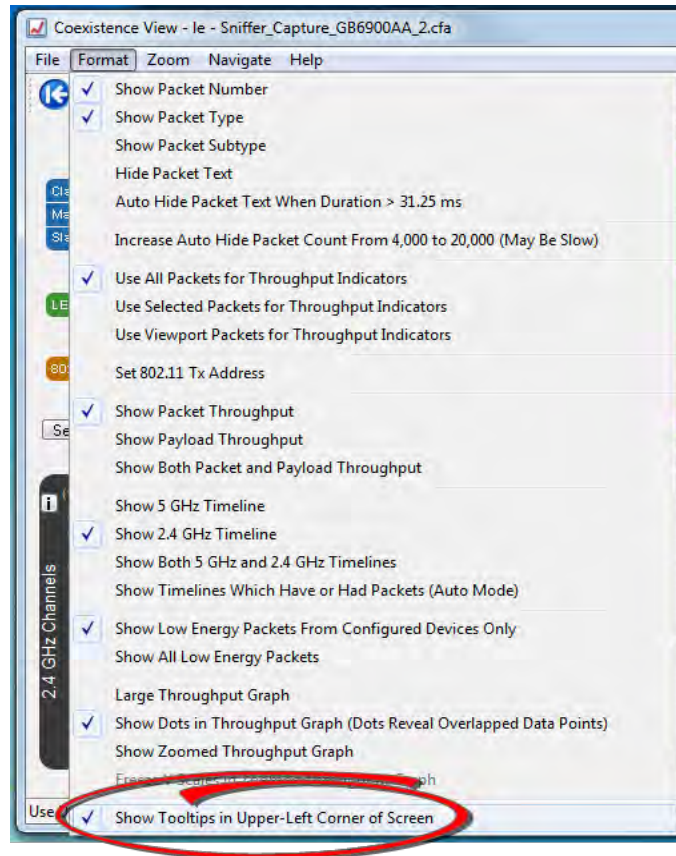

Figure 4.69 - Coexistence View Format Menu - Show Tooltips on Computer Screen

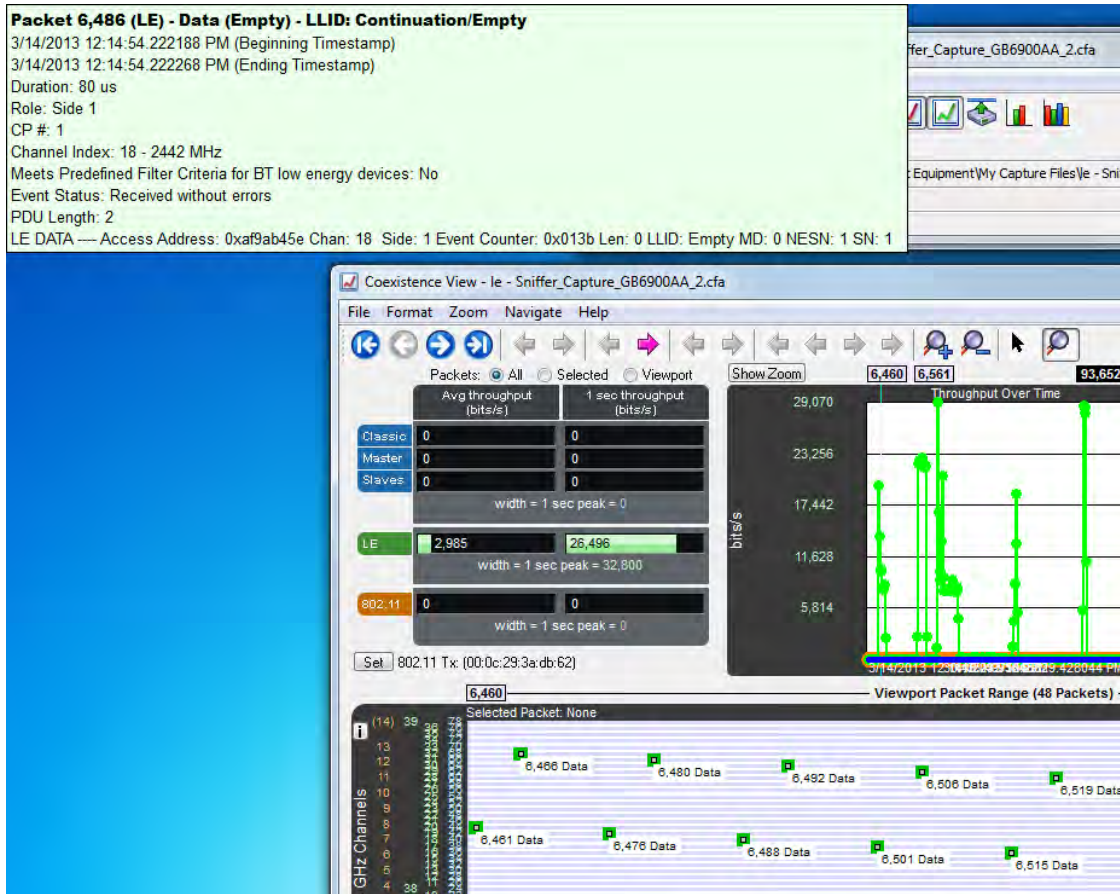

Figure 4.70 - Coexistence View Timeline Tool Tip Shown Anchored to Computer Screen

4.3.2.29 The two Timelines

There are two **Timelines** available for viewing, one for the 5 GHz range and one for the 2.4 GHz range. Classic *Bluetooth* and *Bluetooth* low energy occur only in the 2.4 GHz range. 802.11 can occur in both.

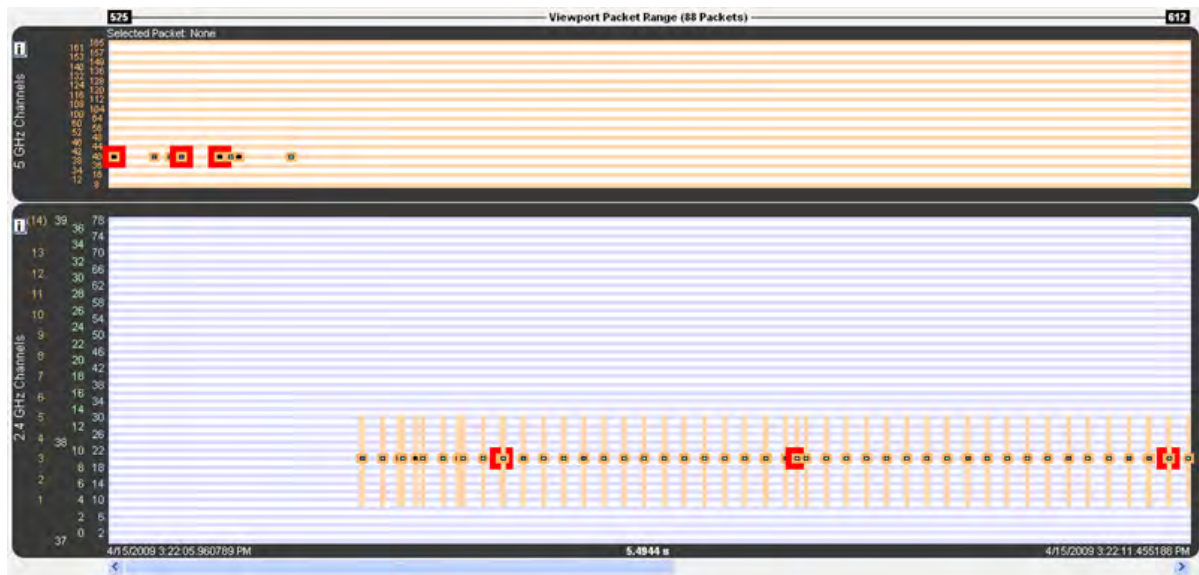

Figure 4.71 - 5 GHz and 2.4 GHz 802.11 packets

The y-axis labels show the channels for each technology and are color-coded: Blue = Classic *Bluetooth*, Green = *Bluetooth* low energy, Orange = 802.11.

The 5 GHz timeline has only 802.11 channel labels, and the rows alternate orange and white, one row per channel.

The 2.4 GHz timeline has labels for all three technologies. The rows alternate blue and white, one row per Classic *Bluetooth* channel. The labels going left-to-right are 802.11 channels, *Bluetooth* low energy advertising channels, *Bluetooth* low energy regular channels, and Classic *Bluetooth* channels.

The **Viewpoint Packet Range** above the timelines shows the packet range and packet count of packets that would be visible if both timelines were shown (i.e. hiding one of the timelines doesn't change the packet range or count). This packet range matches the packet range shown above the viewport in the [Throughput Graph](#), as it must since the viewport defines the time range used by the timelines. When no packets are in the time range, each of the two packet numbers is drawn with an arrow to indicate the next packet in each direction and can be clicked on to navigate to that packet (the packet number changes color when the mouse pointer is placed on it in this case).

 An arrow points to the next packet when no packets are in the time range.

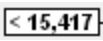
 An arrowed packet number changes color when the mouse pointer is on it. Clicking navigates to that packet.

The header shows information for packets that are selected.

The footer shows the beginning/ending timestamps and visible duration of the timelines.

The 'i' buttons bring up channel information windows, which describe channel details for each technology. They make for interesting reading.

802.11 5 GHz
 Only channels with a base value of 5 GHz and spacings of either 20 or 40 MHz are shown here. Due to space limitations, each channel is drawn with fixed spacing instead of being spaced relative to its distance from other channels as is done with 2.4 GHz channels (with the exception of 802.11 channel 14).

Figure 4.72 - 5 GHz information window

Bluetooth Classic
 There are 79 Classic channels. Each channel is 1 MHz wide and has the indicated center frequency. Channels do not overlap.
 0 = 2402 MHz 10 = 2412 MHz 20 = 2422 MHz 30 = 2432 MHz 40 = 2442 MHz 50 = 2452 MHz 60 = 2462 MHz 70 = 2472 MHz
 1 = 2403 MHz 11 = 2413 MHz 21 = 2423 MHz 31 = 2433 MHz 41 = 2443 MHz 51 = 2453 MHz 61 = 2463 MHz 71 = 2473 MHz
 2 = 2404 MHz 12 = 2414 MHz 22 = 2424 MHz 32 = 2434 MHz 42 = 2444 MHz 52 = 2454 MHz 62 = 2464 MHz 72 = 2474 MHz
 3 = 2405 MHz 13 = 2415 MHz 23 = 2425 MHz 33 = 2435 MHz 43 = 2445 MHz 53 = 2455 MHz 63 = 2465 MHz 73 = 2475 MHz
 4 = 2406 MHz 14 = 2416 MHz 24 = 2426 MHz 34 = 2436 MHz 44 = 2446 MHz 54 = 2456 MHz 64 = 2466 MHz 74 = 2476 MHz
 5 = 2407 MHz 15 = 2417 MHz 25 = 2427 MHz 35 = 2437 MHz 45 = 2447 MHz 55 = 2457 MHz 65 = 2467 MHz 75 = 2477 MHz
 6 = 2408 MHz 16 = 2418 MHz 26 = 2428 MHz 36 = 2438 MHz 46 = 2448 MHz 56 = 2458 MHz 66 = 2468 MHz 76 = 2478 MHz
 7 = 2409 MHz 17 = 2419 MHz 27 = 2429 MHz 37 = 2439 MHz 47 = 2449 MHz 57 = 2459 MHz 67 = 2469 MHz 77 = 2479 MHz
 8 = 2410 MHz 18 = 2420 MHz 28 = 2430 MHz 38 = 2440 MHz 48 = 2450 MHz 58 = 2460 MHz 68 = 2470 MHz 78 = 2480 MHz
 9 = 2411 MHz 19 = 2421 MHz 29 = 2431 MHz 39 = 2441 MHz 49 = 2451 MHz 59 = 2461 MHz 69 = 2471 MHz
 The row labels are placed at the center frequency of each channel.

Bluetooth low energy (LE)
 There are 40 LE channels. Each channel is 2 MHz wide and has the indicated center frequency. Channels do not overlap.
 Channels 0 through 36 are Data channels. Channels 37 through 39 are Advertising channels.
 37 = 2402 MHz 4 = 2412 MHz 9 = 2422 MHz 13 = 2432 MHz 18 = 2442 MHz 23 = 2452 MHz 28 = 2462 MHz 33 = 2472 MHz
 0 = 2404 MHz 5 = 2414 MHz 10 = 2424 MHz 14 = 2434 MHz 19 = 2444 MHz 24 = 2454 MHz 29 = 2464 MHz 34 = 2474 MHz
 1 = 2406 MHz 6 = 2416 MHz 38 = 2426 MHz 15 = 2436 MHz 20 = 2446 MHz 25 = 2456 MHz 30 = 2466 MHz 35 = 2476 MHz
 2 = 2408 MHz 7 = 2418 MHz 11 = 2428 MHz 16 = 2438 MHz 21 = 2448 MHz 26 = 2458 MHz 31 = 2468 MHz 36 = 2478 MHz
 3 = 2410 MHz 8 = 2420 MHz 12 = 2430 MHz 17 = 2440 MHz 22 = 2450 MHz 27 = 2460 MHz 32 = 2470 MHz 39 = 2480 MHz
 The row labels are placed at the center frequency of each channel.

802.11 2.4 GHz
 In the 802.11 2.4 GHz frequency range there are 11 channels in the USA, 13 in Europe, and 14 in Japan. Each channel is 22 MHz wide. Channels overlap.
 There is a 5 MHz shift between each of the first 13 channels. There is a 12 MHz shift between channels 13 and 14.
 1 = 2401-2423 MHz (centered at 2412 MHz) (USA, Europe, Japan) 8 = 2436-2458 MHz (centered at 2447 MHz) (USA, Europe, Japan)
 2 = 2406-2428 MHz (centered at 2417 MHz) (USA, Europe, Japan) 9 = 2441-2463 MHz (centered at 2452 MHz) (USA, Europe, Japan)
 3 = 2411-2433 MHz (centered at 2422 MHz) (USA, Europe, Japan) 10 = 2446-2468 MHz (centered at 2457 MHz) (USA, Europe, Japan)
 4 = 2416-2438 MHz (centered at 2427 MHz) (USA, Europe, Japan) 11 = 2451-2473 MHz (centered at 2462 MHz) (USA, Europe, Japan)
 5 = 2421-2443 MHz (centered at 2432 MHz) (USA, Europe, Japan) 12 = 2456-2478 MHz (centered at 2467 MHz) (Europe, Japan)
 6 = 2426-2448 MHz (centered at 2437 MHz) (USA, Europe, Japan) 13 = 2461-2483 MHz (centered at 2472 MHz) (Europe, Japan)
 7 = 2431-2453 MHz (centered at 2442 MHz) (USA, Europe, Japan) 14 = 2473-2495 MHz (centered at 2484 MHz) (Japan)
 The row labels for 802.11 channels 1-13 are placed at the center frequency of each channel.
 The row label for 802.11 channel 14 is in parentheses because that channel's center frequency is above the top of the graph.

Figure 4.73 - 2.4 GHz information windows

4.3.2.30 Bluetooth slot markers

When zoomed in far enough *Bluetooth* slot markers appear in the 2.4 GHz timeline. A *Bluetooth* slot is 625 μ s wide.

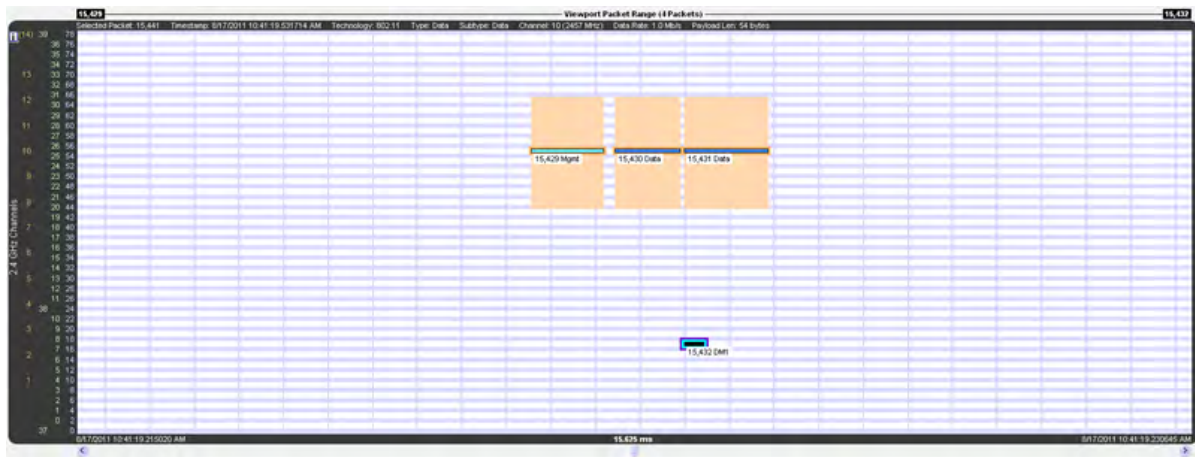

Figure 4.74 - Vertical blue lines are *Bluetooth* slot markers

4.3.2.31 Zooming

There are various ways to zoom:

1. Drag one of the sides of the **Throughput Graph** viewport.
2. Select a zoom preset from the **Zoom** or right-click menus.
3. Select the **Zoom In** or **Zoom Out** button or menu item.
4. Turn the mouse wheel in the **Timelines** or the **Zoomed Throughput Graph** while the zoom cursor is selected. The action is the same as selecting the **Zoom In** and **Zoom Out** buttons and menu items except that the time point at the mouse pointer is kept in place if possible.
5. Select the **Zoom to Data Point Packet Range** menu item, which zooms to the packet range shown in the most recently displayed tool tip.
6. Select the **Zoom to Selected Packet Range** menu item, which zooms to the selected packet range as indicated in the **Selected Packets** text in the timeline header.
7. Select the **Custom Zoom** menu item. This is the zoom level from the most recent drag of a viewport side, selection of **Zoom to Data Point Packet Range**, or selection of **Zoom to Selected Packet**.

The zoom buttons and tools step through the zoom presets and custom zoom, where the custom zoom is logically inserted in value order into the zoom preset list for this purpose.

4.3.2.32 Discontinuities

([Click here to see a Timeline Discontinuities video...](#))

A discontinuity is when the timestamp going from one packet to the next either goes backward by any amount or forward by more than 4.01 s (this value is used because the largest possible connection interval in *Bluetooth* low energy is 4.0 s). A discontinuity is drawn as a vertical cross-hatched area one *Bluetooth* slot (625 μ s) in width. A discontinuity for a timestamp going backward is called a negative discontinuity and is shown in red. A discontinuity for a timestamp going forward by more than 4.01 s is called a positive discontinuity and is shown in black. A positive discontinuity is a cosmetic nicety to avoid lots of empty space. A negative discontinuity is an error.

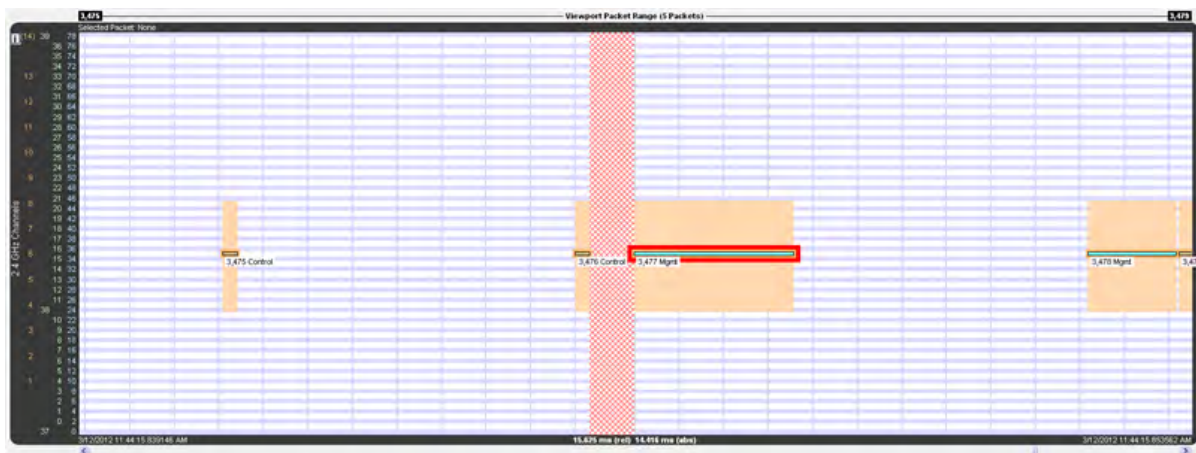

Figure 4.75 - A negative discontinuity

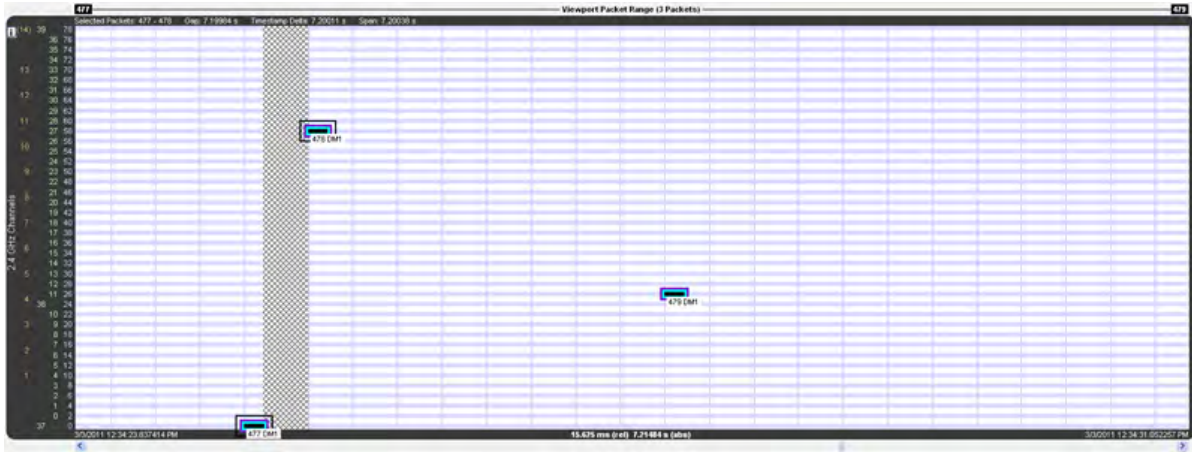

Figure 4.76 - A positive discontinuity

When there are one or more discontinuities the actual time encompassed by the visible timeline differs from the zoom level duration that would apply in the absence of any discontinuities. The actual time, referred to as absolute time, is shown followed by “(abs)”. The zoom level duration, referred to as relative time, is shown followed by “(rel)”. When there are no discontinuities, relative and absolute time are the same and a single value is shown.

Selected Packets: 477 - 478 Gap: 7.19984 s Timestamp Delta: 7.20011 s Span: 7.20038 s

Figure 4.77 - Timeline header with discontinuity

15.625 ms (rel) 7.21484 s (abs)

Figure 4.78 - Timeline duration footer with discontinuity

For example, the timeline above has a zoom level duration of 15.625 ms (the relative time shown in the footer). But the discontinuity graphic consumes the width of a *Bluetooth* slot (625 μs), and that area is 7.19984 s of absolute time as shown by the Gap value in the header. So the absolute time is 7.21484 s:

Zoom level duration – *Bluetooth* slot duration + Gap duration =

$$15.625 \text{ ms} - 625 \mu\text{s} + 7.19984 \text{ s} =$$

$$0.015625 \text{ s} - 0.000625 \text{ s} + 7.199840 \text{ s} =$$

$$0.015000 \text{ s} + 7.199840 \text{ s} =$$

$$7.214840 \text{ s} =$$

$$7.21484 \text{ s}$$

4.3.2.33 High-Speed *Bluetooth*

High-speed *Bluetooth* packets, where *Bluetooth* content hitches a ride on 802.11 packets, have a blue frequency range box instead of orange as with regular 802.11 packets (both are shown below), and the tool tip has two colors, orange for 802.11 layers and blue for *Bluetooth* layers.



Figure 4.79 - High-speed *Bluetooth* packets have a blue frequency box and a two-tone tool tip

4.3.2.34 High Speed Live View

When using the Frontline® 802.11 in conjunction with other ComProbe devices, or in a stand-alone configuration, a smaller version of the standard **Coexistence View** is available. This **High Speed Live View** is essentially the **Viewport** from the standard **Coexistence View**.

When viewing **High Speed Live**, only 802.11 traffic is visible. Because *Bluetooth* packets are slow they are not visible in High Speed mode.

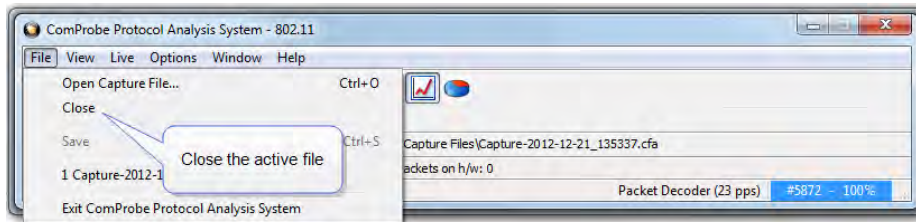

1. Click on the **Control** window **File** menu and select **Close**.

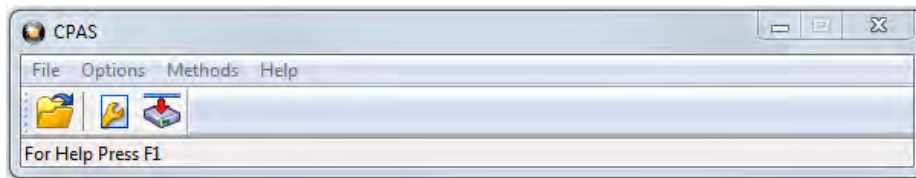

2. The **Control** window will open again. Click on the Control Window **File** menu and select **Go Live (High-Speed Mode)**

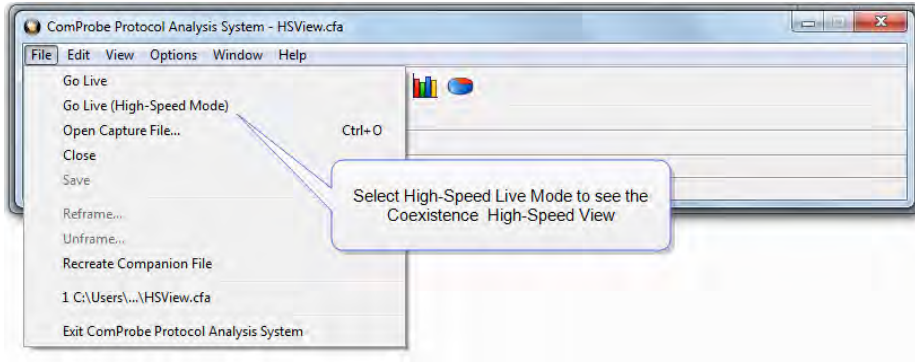



3. Click on the **Control** window **Start Capture** button  to begin capturing data. Click on the **Coexistence View** button  and the **High-Speed View** will appear.

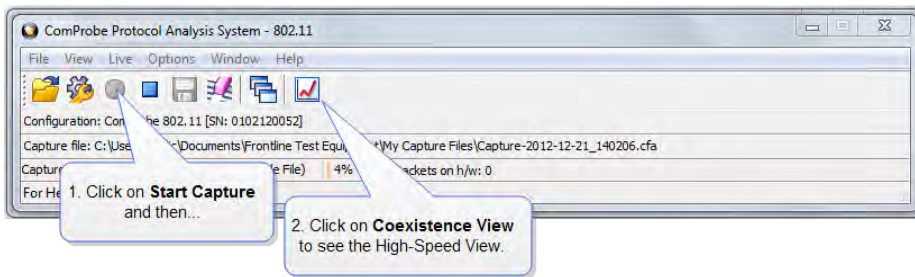

The Coexistence View (High Speed Live Mode) window will appear.

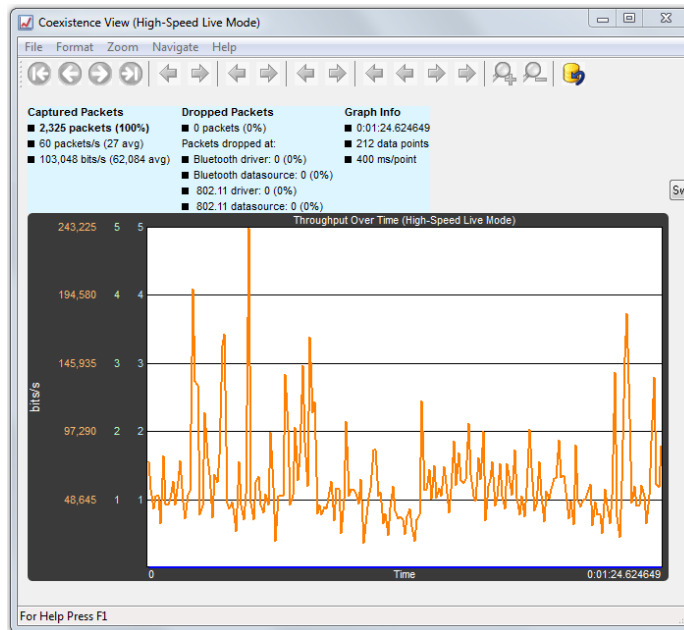

Figure 4.80 - High-Speed Live Window

4.4 Analyzing Byte Level Data

4.4.1 Event Display

To open this window click the **Event Display** icon  on the **Control** window toolbar.

The **Event Display** window provides detailed information about every captured event. Events include data bytes, data related information such as start-of-frame and end-of-frame flags, and the analyzer information, such as when the data capture was paused. Data bytes are displayed in hex on the left side of the window, with the corresponding ASCII character on the right.

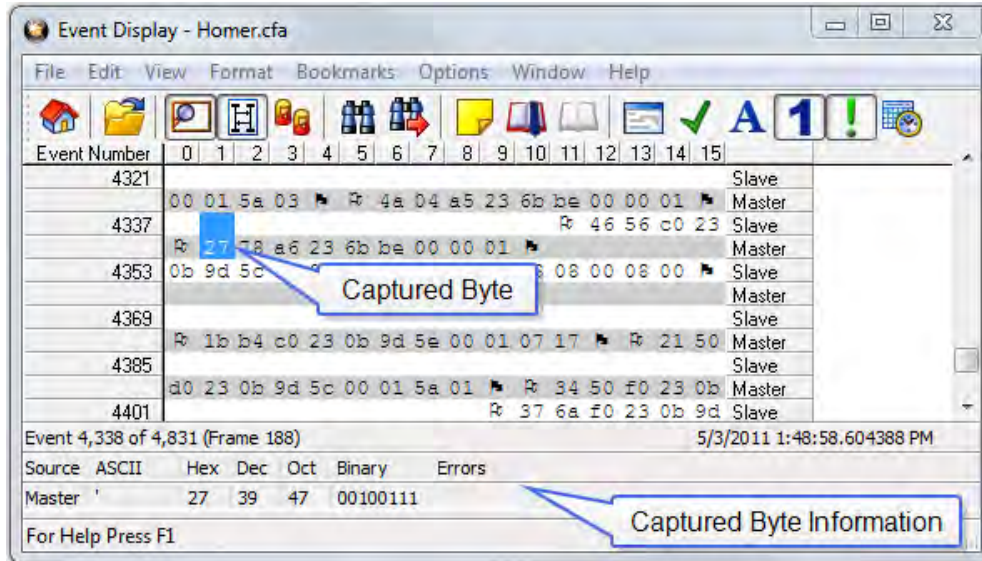



Figure 4.81 - Event Display

Click on an event to find out more about it. The three status lines at the bottom of the window are updated with information such as the time the event occurred (for data bytes, the time the byte was captured), the value of the byte in hex, decimal, octal, and binary, any errors associated with the byte, and more.

















Events with errors are shown in red to make them easy to spot.





When capturing data live, the analyzer continually updates the Event Display as data is captured. Make sure the **Lock** icon  is displayed on the toolbar to prevent the display from updating (Clicking on the icon again will unlock the display). While locked, you can review your data, run searches, determine delta time intervals between bytes, and check CRCs. To resume updating the display, click the **Lock** icon again.

You can have more than one **Event Display** open at a time. Click the **Duplicate View** icon  to create a second, independent **Event Display** window. You can lock one copy of the **Event Display** and analyze your data, while the second **Event Display** updates as new data is captured.

Event Display is synchronized with the **Frame Display** and **Message Sequence Chart** dialogs. Selecting a byte in **Event Display** will also select the related frame in the **Frame Display** and the related message in the **Message Sequence Chart**.

4.4.2 The Event Display Toolbar

-  Home – Brings the Control window to the front.
-  Open a capture file
-  Start Capture - Begins data capture to disk.
-  Stop Capture - Closes a capture file and stops data capture to disk.
-  Save - Prompts user for a file name. If the user supplies a name, a .cfa file is saved.
-  Clear- Discards the temporary file and clears the display.
-  Lock - In the Lock state, the window is locked so you can review a portion of data. Data capture continues in the background. Clicking on the Lock icon unlocks the window.
-  Unlock - In the Unlock state, the screen fills in the data captured since the screen lock and moves down to display incoming data again. Clicking on the Unlock icon locks the window.
-  Duplicate View - Creates a second Event Display window identical to the first.
-  Frame Display - (framed data only) Brings up a Frame Display, with the frame of the currently selected bytes highlighted.
-  Display Capture Notes - Brings up the Capture Notes window where you can view or add notes to the capture file.
-  Add/Modify Bookmark - Add a new or modify an existing bookmark.
-  Display All Bookmarks - Shows all bookmarks and lets you move between bookmarks.
-  Find - Search for errors, string patterns, special events and more.
-  Go To - Opens the Go To dialog, where you can specify which event number to go to.
-  CRC - Change the algorithm and seed value used to calculate CRCs. To calculate a CRC, select a byte range, and the CRC appears in the status lines at the bottom of the Event Display.
-  Mixed Sides - (Serial data only) By default, the analyzer shows data with the DTE side above the DCE side. This is called DTE over DCE format. DTE data has a white background and DCE data has a gray background. The analyzer can also display data in mixed side format. In this format, the analyzer does not separate DTE data from DCE data but shows all data on the same line as it comes in. DTE data is still shown with a white background and DCE data with a gray background so that you can distinguish between the two. The benefit of using this format is that more data fits onto one screen.

-  **Character Only** - The analyzer shows both the number (hex, binary, etc.) data and the character (ASCII, EBCDIC or BAUDOT) data on the same screen. If you do not wish to see the hex characters, click on the Character Only button. Click again to go back to both number and character mode.
-  **Number Only** - Controls whether the analyzer displays data in both character and number format, or just number format. Click once to show only numeric values, and again to show both character and numeric values.
-  **All Events** - Controls whether the analyzer shows all events in the window, or only data bytes. Events include control signal changes and framing information.
-  **Timestamping Options** – Brings up the timestamping options window which has options for customizing the display and capture of timestamps.

4.4.3 Opening Multiple Event Display Windows



Click the **Duplicate View** icon  from the **Event Display** toolbar to open a second **Event Display** window.

You can open as many **Event Display** windows as you like. Each **Event Display** is independent of the others and can show different data, use a different radix or character set, or be frozen or live.

The **Event Display** windows are numbered in the title bar. If you have multiple **Event Displays** open, click on the **Event Display** icon  on the **Control** window toolbar to show a list of all the **Event Displays** currently open. Select a window from the list to bring it to the front.

4.4.4 Calculating CRCs or FCSs

The cyclic redundancy check (CRC) is a function on the **Event Display** window used to produce a checksum. The frame check sequence (FCS) are the extra checksum characters added to a frame to detect errors.

1. Open the **Event Display**  window.
2. Click and drag to select the data for which you want to generate a CRC.
3. Click on the **CRC** icon .
4. In the **CRC** dialog box, click on the down arrow to show the list of choices for CRC algorithms. Choose an algorithm to use. Choose CRC 32 (Ethernet). Choose CRC 32 (Ethernet) for Ethernet data or the appropriate CRC type for serial data.
5. Enter a **Seed** value in hexadecimal if desired.
6. Click **OK** to generate the CRC. It appears in the byte information lines at the bottom of the Event Display window. Whenever you select a range of data, a CRC using the algorithm you selected is calculated automatically.

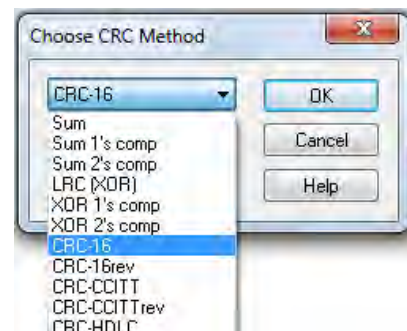

Calculating CRC for interwoven data

Frontline calculates the CRC for either side of the interwoven data. Which side it calculates is determined by the first byte selected. If the first byte is from one side, then Frontline calculates the CRC for just the bytes on that side. If the first byte is from the other side, then Frontline calculates the CRC for just the bytes on that side.

Incorrect results with CRC16 for serial data

If you are calculating CRCs using the CRC16 algorithm and the CRCs do not match what you know they should be, try CRC16rev. What hardware often calls CRC16 is what software calls CRC16rev.

4.4.5 Calculating Delta Times and Data Rates

1. Click on the **Event Display** icon  on the **Control** window to open the **Event Display** window.
2. Use the mouse to select the data you want to calculate a delta time and rate for.
3. The **Event Display** window displays the delta time and the data rate in the status lines at the bottom of the window.

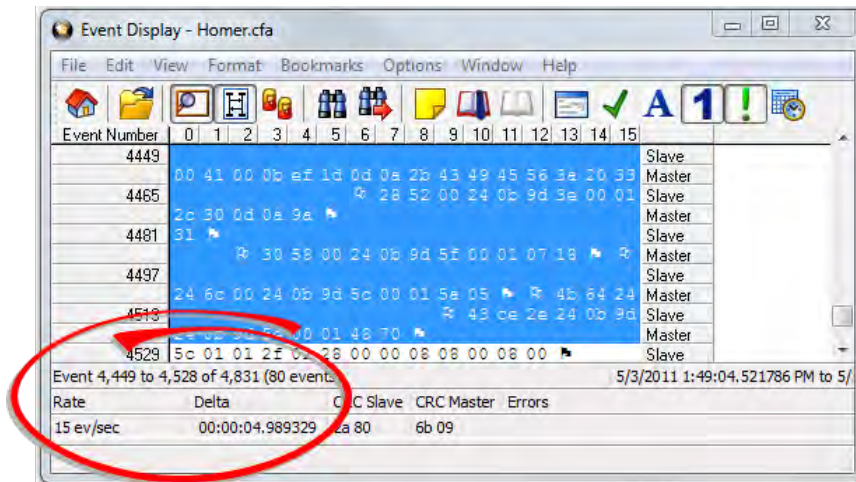





Figure 4.82 - Delta fields

4.4.6 Switching Between Live Update and Review Mode

The **Event Display** and **Frame Display** windows can update to display new data during live capture, or be frozen to allow data analysis. By default, the **Event Display** continually updates with new data, and the **Frame Display** is locked.

1. Make sure the **Lock** icon  is active so the display is locked and unable to scroll.
2. Click the **Unlock**  icon again to resume live update.

The analyzer continues to capture data in the background while the display is locked. Upon resuming live update, the display updates with the latest data.

You can have more than one **Event Display** or **Frame Display** window open at a time. Click the **Duplicate View** icon  to open additional Event or Frame Display windows. The lock/resume function is independent on

each window. This means that you can have two **Event Display** windows open simultaneously, and one window can be locked while the other continues to update.

4.4.7 Data Formats and Symbols

4.4.7.1 Switching Between Viewing All Events and Viewing Data Events

By default, the analyzer on the Event Display dialog shows all **events**¹ that include:

- Data bytes
- Start-of-frame
- End-of-frame characters
- Data Captured Was Paused.

Click on the **Display All Events** icon  to remove the non-data events. Click again to display all events.

See [on page 137](#) for a list of all the special events shown in the analyzer and what they mean.

4.4.7.2 Switching Between Hex, Decimal, Octal or Binary

On the Event Display window the analyzer displays data in Hex by default. There are several ways to change the **radix**² used to display data.

Go to the **Format** menu and select the radix you want. A check mark next to the radix indicates which set is currently being used.

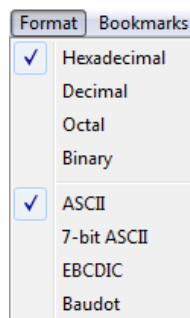

Figure 4.83 - Format Menu

¹An event is anything that happens on the circuit or which affects data capture. Data bytes, control signal changes, and long and short breaks are all events, as are I/O Settings changes and Data Capture Paused and Resumed.

²The base of a number system. Binary is base 2, octal is base 8, decimal is base 10 and hexadecimal is base 16.

1. Right-click on the data display header labels and choose a different radix.

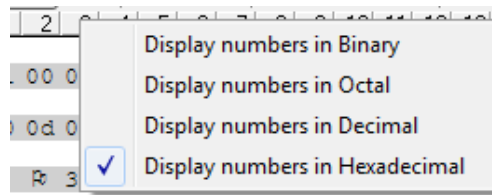

Figure 4.84 - Header labels, right click

2. Or right-click anywhere in the data display and select a different radix.

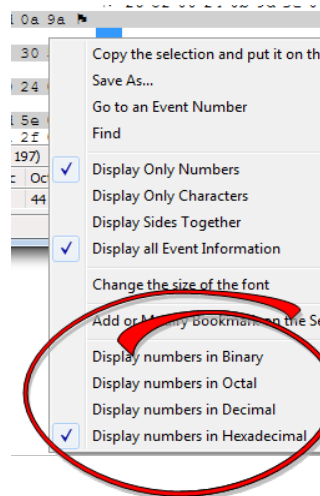





Figure 4.85 - Data display right click menu

If you want to see only the numerical values, click on the **Numbers Only** icon  on the **Event Display** toolbar.

4.4.7.3 Switching Between ASCII, EBCDIC, and Baudot

On the **Event Display** window, the analyzer displays data in ASCII by default when you click on the **Characters Only** icon . There are several ways to change the character set used to display data.

1. Go to the **Format** menu and select the character set you want. A check mark next to the character set indicates which set is currently being used.
2. With the data displayed in characters, right-click on the data panel header label to choose a different character set.

If you want to see only characters, click on the **Characters Only** icon  on the **Event Display** toolbar.

4.4.7.4 Selecting Mixed Channel/Sides

If you want to get more data on the **Event Display** window, you can switch to mixed sides mode. This mode puts all the data together on the same line. Data from one side (**Slave**) is shown on a white background and data from the other side (**Master**) is shown on a gray background.

1. Click once on the **Mixed Sides** icon  to put the display in mixed sides mode.
2. Click again to return to side over side mode.
3. You can right click in the center of the data display window to change between mixed and side over side modes by selecting **Display Sides Together**. A check mark is displayed. Click on **Display Sides Together** to remove the check mark and return to side-by-side display.
4. Right click in the sides panel on the right of the data display and select **Display Sides Together**. A check mark is displayed. Click on **Display Sides Together** to remove the check mark and return to side-by-side display.









4.4.7.5 List of all Event Symbols

By default, the **Event Display** shows all **events**¹, which includes control signal changes, start and end of frame characters and flow control changes. If you want to see only the data bytes, click on the All Events button . Click again to display all events.

Click on a symbol, and the analyzer displays the symbol name and sometimes additional information in the status lines at the bottom of the **Event Display** window. For example, clicking on a control signal change symbol displays which signal(s) changed.

In addition to data bytes, the events shown are (in alphabetical order):

Table 4.8 - Event Symbols

Symbol	Event
	Abort
	Broken Frame - The frame did not end when the analyzer expected it to. This occurs most often with protocols where the framing is indicated by a specific character, control signal change, or other data related event.
	Buffer Overflow - Indicates a buffer overflow error. A buffer overflow always causes a broken frame.
	Control Signal Change - One or more control signals changed state. Click on the symbol, and the analyzer displays which signal(s) changed at the bottom of the Event Display window.
	Data Capture Paused - The Pause icon was clicked, pausing data capture. No data is recorded while capture is paused.
	Data Capture Resumed - The Pause icon was clicked again, resuming data capture.
	Dropped Frames - Some number of frames were lost. Click on the symbol, and the analyzer displays many frames were lost at the bottom of the Event Display window.
	End of Frame - Marks the end of a frame.

¹An event is anything that happens on the circuit or which affects data capture. Data bytes, control signal changes, and long and short breaks are all events, as are I/O Settings changes and Data Capture Paused and Resumed.

Table 4.8 - Event Symbols (continued)























Symbol	Event
	Flow Control Active - An event occurred which caused flow control to become active (i.e. caused the analyzer to stop transmitting data) Events which activate flow control are signal changes or the receipt of an XON character.
	Flow Control Inactive - An event occurred which caused flow control to become inactive (i.e. caused the analyzer to transmit data). Events which deactivate flow control are signal changes or the receipt of an XOFF character.
	Frame Recognizer Change - A lowest layer protocol was selected or removed here, causing the frame recognizer to be turned off or on.
	I/O Settings Change - A change was made in the I/O Settings window which altered the baud, parity, or other circuit setting.
	Long Break
	Low Power - The battery in the ComProbe® is low.
	Short Break
	SPY Event (SPY Mode only) - SPY events are commands sent by the application being spied on to the UART.
	Start of Frame - Marks the start of a frame.
	Begin Sync Character Strip
	End Sync Character Strip
	Sync Dropped
	Sync Found
	Sync Hunt Entered
	Sync Lost
	Test Device Stopped Responding - The analyzer lost contact with the ComProbe for some reason, often because there is no power to the ComProbe.
	Test Device Began Responding - The analyzer regained contact with the ComProbe.
	Timestamping Disabled - Timestamping was turned off. Events following this event are not timestamped.
	Timestamping Enabled - Timestamping was turned on. Events following this event have timestamps.
	Truncated Frame- A frame that is not the same size as indicated within its protocol.
	Underrun Error

Table 4.8 - Event Symbols (continued)

Symbol	Event
	Unknown Event

4.4.7.6 Font Size

The font size can be changed on several **Event Display** windows. Changing the font size on one window does not affect the font size on any other window.

To change the font size:

1. Click on **Event Display** menu **Options**, and select **Change the Font Size**.

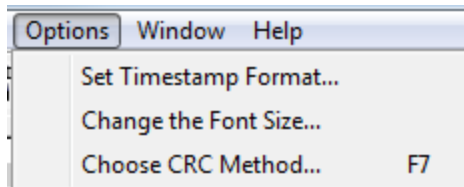

Figure 4.86 - Event Display Options menu

2. Choose a font size from the list.

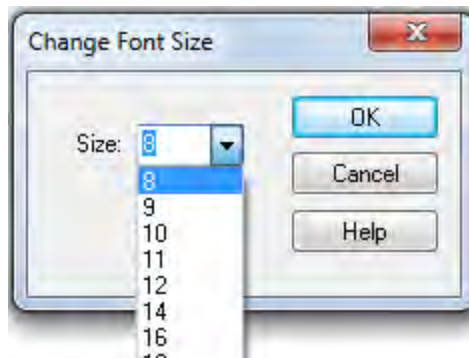

Figure 4.87 - Event Display Font Size Selection

3. Click **OK**.

4.5 Data/Audio Extraction

You use Data/Audio Extraction to pull out data from various decoded *Bluetooth* protocols. Once you have extracted the data, you can save them into different file types, such as text files, graphic files, email files, .mp3 files, and more. Then you can examine the specific files information individually.

1. You access this dialog by selecting Extract Data/Audio from the View menu or by clicking on the icon from

the toolbar .

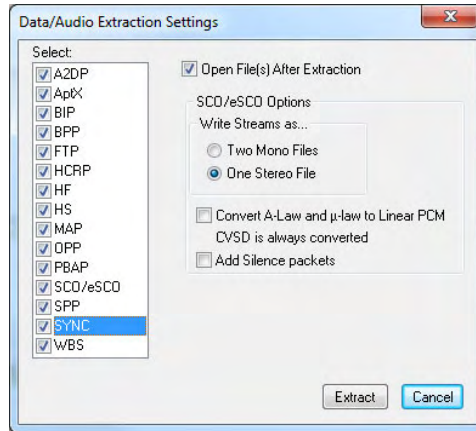

Figure 4.88 - Data/Audio Extraction Settings dialog

2. Choose a checkbox(es) on the left side of the dialog to identify from which profile(s) you want to extract data.

It's important to note that if there is no data for the profile(s) you select, no extracted file is created.

3. If you want the file(s) to open automatically after they are extracted, select the **Open File(s) After Extraction** checkbox.

Note: This does not work for SCO/eSCO.

4. Click on a radio button to write the streams as **Two Mono Files** or as **One Stereo File**.

Note: This option is for SCO/eSCO only.

5. Select the checkbox if you want to convert **A-Law and μ -law to Linear PCM**. CVSD are always converted to Linear PCM. It's probably a good idea to convert to Linear PCM since more media players accept this format.

Note: This option is for SCO/eSCO only.

6. Select the **Add Silence packets** to insert the silence packets (dummy packets) for the reserved empty slots into the extracted file. If this option is not selected, the audio packets are extracted without inserting the silence packets for the reserved empty slots.

Note: This option is for SCO/eSCO only.

7. Select **Extract**.

A **Save As** dialog appears.

The application will assign a file name and file type for each profile you select in Step 1 above. The file type varies depending on the original profile. A separate file for each profile will be created, but only for those profiles with available data.

8. Select a location for the file.

9. Click **Save**.

The **Data Extraction Status** and **Audio Extraction Status** dialogs appear. When the process is complete the dialogs display what files have been created and where they are located.

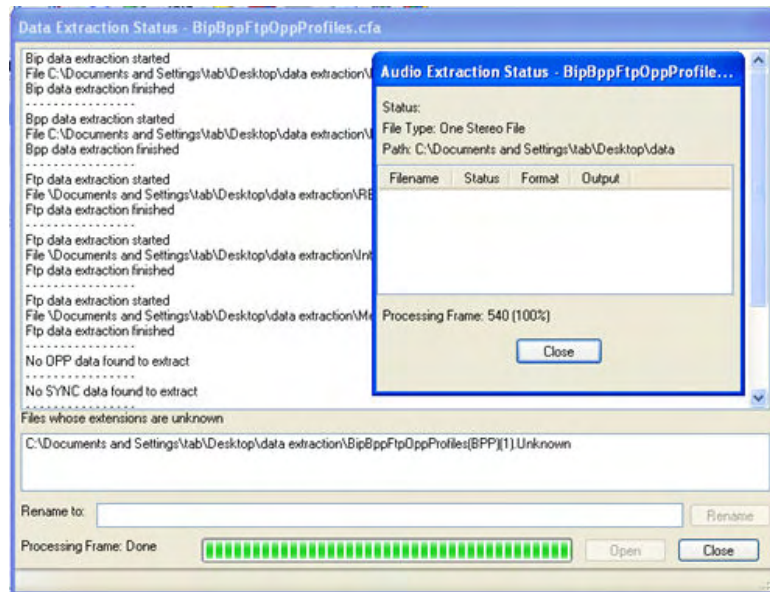
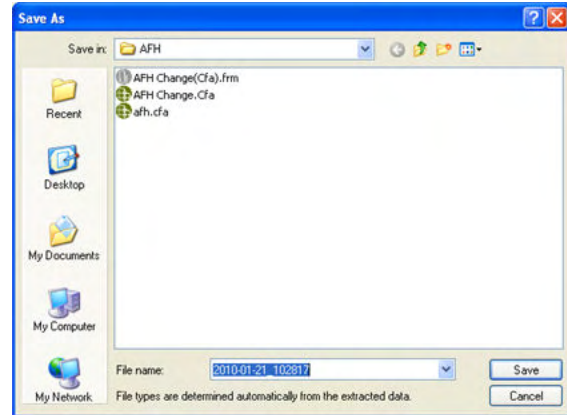

Figure 4.89 - Data and Audio Extraction Status

If you selected **Open Files(s) After Extraction**, the files open automatically.

10. If you did not select this option, you can open a file by simply double-clicking on the name.

Also, if a file type is unknown, you can select the file and it appears in the **Rename to:** text box.



Figure 4.90 - Rename To in the bottom section of Data Extraction Status

Then you can rename the file, adding a file type to attempt to open the file.

When you are finished, select **Close** to close the dialogs.

4.6 Statistics

4.6.1 Statistics Window

The Statistics window supplies basic information about the data on the network. When reviewing a capture file, the **Statistics** window shows a summary of the data in the file.

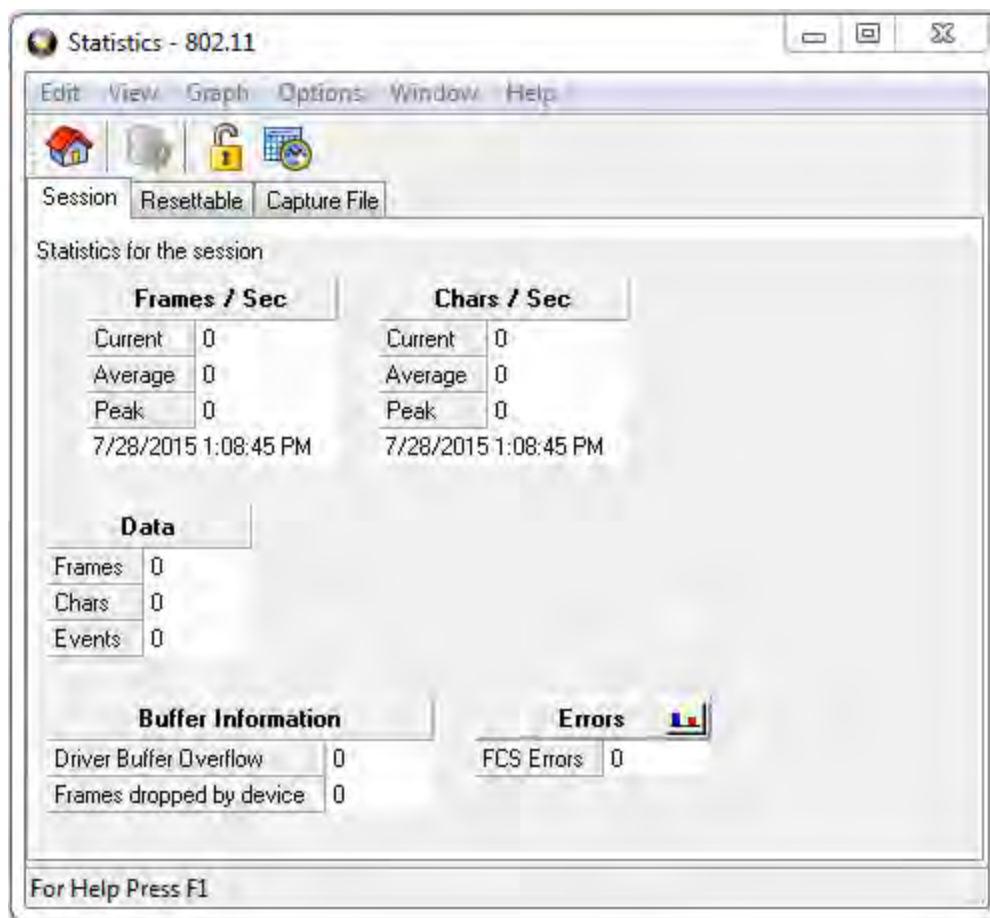



Figure 4.91 - 802.11 Statistics Window

To open the **Statistics** window, click the Statistics icon  on the **Control** window toolbar, or choose **Statistics** from the **View** menu on the **Control** window.

The analyzer monitors the network and collects statistics all the time, even when data is not actively being captured. Activate the **Lock** icon  to stop the window from updating. Click the **Unlock** icon  again to resume updating. The analyzer continues to monitor network traffic while the **Statistics** window is locked, so you may see the numbers jump right after updating has resumed, reflecting all the statistics that were gathered while the window was locked.

Statistics Window Menus

Table 4.9 - 802.11 Statistics Window Menus





Menu	Selection	Description
Edit	Copy All To Clipboard	Copies all statistics to the Windows clipboard.
	Notes	Opens the notes dialog for recording comments on a capture file. Only available when view a capture file.
	Copy Chars/Sec To Clipboard	Copies the character rate statistics to the Windows clipboard.
	Copy Data To Clipboard	Copies data statistics to the Windows clipboard.
	Copy Errors To Clipboard	Copies only the FSC error statistics to the Windows clipboard.
	Copy Buffer To Clipboard	Copies only the data currently in the buffer to the Windows Clipboard.
	Copy Frames/Sec To Clipboard	Copies the frame rate statistics to the Windows clipboard
View	Control Window	When checked will open the window or Statistics Window bar. When not checked, the window or bar is closed.
	Event Display	
	Frame Display	
	Toolbar	
	Status Bar	
	Toggle Display Lock	When checked, the displayed statistics will stop updating, although data is still being captured. Unchecking will resume statistics updating.
	Reset	Available during live capture. Resets all displayed statistics and restarts the calculations.
Graph	Graph Errors...	Opens the Errors 802.11 window.
Options	I/O Settings...	Performs the same function as the control Window Options Menu, I/O Settings
	Set Timestamping Format	Opens the Timestamping Options window that allows for changing the resolution of the timestamps.
	Change the Font Size	Opens a pop-up with font size selections.
Window	Close Window	Closes the Statistics Window
	ComProbe Protocol Analysis System	Clicking on these selections will change the focus from the Statistics Window to the selected window.
	Statistics	
	Errors	
Help	Help Topics	Opens the ComProbe Help window.

Table 4.9 - 802.11 Statistics Window Menus (continued)

Menu	Selection	Description
	About ComProbe Protocol Analysis System	Provides a pop-up showing the version and release information, Frontline contact information, and copyright information.
	Support on the Web	Opens a browser to fte.com technical support page.

Statistics Window Toolbar

Table 4.10 - Statistics Window Toolbar Icons

Icon	Description
	Changes the focus to the Control Window
	Reset the statistics tables
	Display Lock/Unlock
	Timestamp Format

4.6.2 Session, Resettable and Capture File Tabs



The **Session**, **Resettable**, and **Capture File** tabs are parts of the **Statistics** and **Errors** windows.

Information about all data collected since the analyzer was started is shown in the **Session** tab. The **Session** tab cannot be reset; in this sense, it is like the odometer on a car. The odometer on a car shows you all the miles driven since the car was built, and the **Session** tab shows you all the data collected since the analyzer was started.

If you think of the **Session** tab as the odometer, then the **Resettable** tab is the trip odometer. It can be reset, and allows you to record statistics for a new "trip". In this way you can effectively start a new session without having to restart the analyzer. If the **Reset** button  was pressed during the capture, then the numbers on this tab differs from the numbers on the Session tab.

7/29/2015 7:04:52 AM

The timestamp appearing in **Session** tab fields is the timestamp of when the analysis began. The timestamp appearing in the **Resettable** tab fields is the timestamp either when the analysis began or when the last Reset was initiated.

The **Capture File** tab shows information on the data that is currently in the capture. If the capture file had become full, the analyzer began to overwrite the oldest data and put new data in its place. This is called "wrapping". If the file wrapped, the numbers on the **Capture File** tab is smaller than those on the Session tab.

Occasionally some of the statistics read "n/a", for Not Available. This happens for various reasons. For example, many of the items on the **Capture File** tab become not available if the buffer becomes full and wraps. When this happens, the analyzer can no longer provide accurate statistics for the data in the file, because some of the data that the statistics are based on has been lost.

4.6.3 Copying Statistics To The Clipboard

Any table in the **Statistics** window can be copied to the clipboard where it can be pasted into any application.

1. Choose the name of the table from the **Edit** menu.
2. To copy the contents of all the tables, choose **Copy All to Clipboard**.

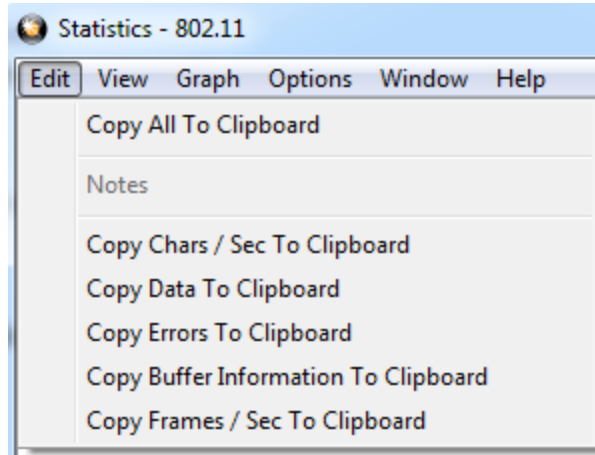

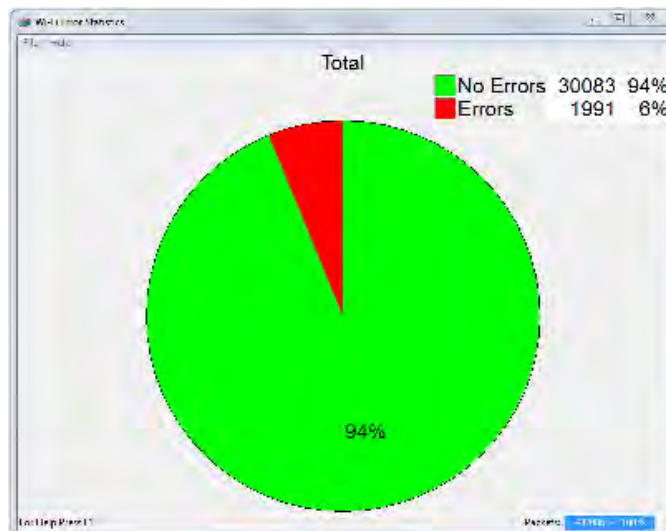

Figure 4.92 - 802.11 Edit Menu for Copying

4.6.4 802.11 Error Statistics

The **Wi-Fi Error Statistics** window appears when you select the window from the  icon in the **Control** window toolbar or the **Frame Display** toolbar. The dialog is view only; there is no user interaction possible.

The window displays the percentage of packets with and without errors in a pie chart and in a table.





4.6.5 Graphs

4.6.5.1 Statistics Errors Graphs

Open the **Statistics** window and click on the picture of a graph  on the Errors table header, or choose the graph name from the Graph menu on the **Statistics** window.

The **Frame Sizes Graph** window has [Session, Resettable and Capture File tabs](#) that correspond to the tabs on the **Statistics** window. Each tab shows the data that corresponds to the appropriate tab on the **Statistics** window.

The window displays the errors in either a pie chart or bar graph format. Click the **Pie** icon  to display a pie chart, and click the **Bar** icon  to display a bar graph.

4.6.5.2 Printing Error Graphs

Click the **Print** icon  to print the graph. The analyzer prints exactly what is shown in the window.

Chapter 5 Navigating and Searching the Data

The following sections describe how to navigate through the data and how to find specific data or packet conditions of interest to the user.

5.1 Find

Capturing and decoding data within the ComProbe analyzer produces a wealth of information for analysis. This mass of information by itself, however, is just that, a mass of information. There has to be ways to manage the information. ComProbe software provides a number of different methods for making the data more accessible. One of these methods is **Find**.





Figure 5.1 - Find Dialog

Find, as the name suggests, is a comprehensive search function that allows users to search for strings or patterns in the data or in the frame decode. You can search for errors, control signal changes, bookmarks, special events, time, and more. Once the information is located, you can easily move to every instance of the Find results.

5.1.1 Searching within Decodes

Searching within decodes lets you to do a string search on the data in the **Decode Pane** of the **Frame Display** window.

To access the search within decodes function:

1. Open a capture file to search.
2. Open the **Event Display**  or **Frame Display**  window.
3. Click on the **Find** icon  or choose **Find** from the **Edit** menu.
4. Click on the **Decode** tab of the **Find** dialog.

Note: The tabs displayed on the Find dialog depend on the product you are running and the content of the capture file you are viewing.

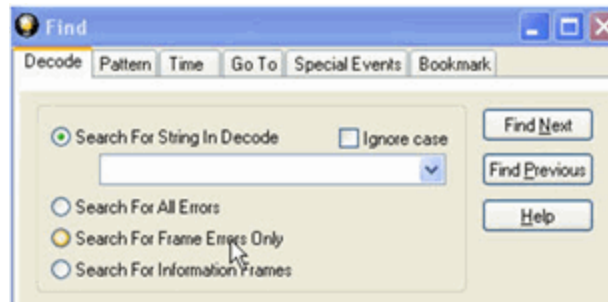

Figure 5.2 - Find Decode Tab Search for String

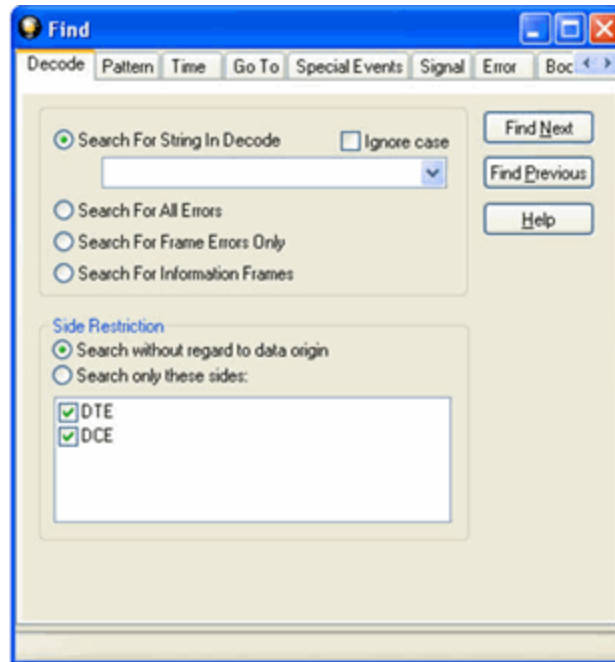

Figure 5.3 - Find Decode Tab Side Restriction

There are several options for error searching on the **Decoder** tab.

- **Search For String in Decoder** allows you to enter a string in the text box. You can use [characters](#), [hex or binary digits](#), [wildcards](#) or a combination of any of the formats when entering your string. Every time you type in a search string, the analyzer saves the search. The next time you open **Find**, the drop-down list will contain your search parameters.
- **Search for All Errors** finds frame errors as well as frames with byte-level errors (such as parity or CRC errors).
- **Search for Frame Errors Only** finds frame specific errors, such as frame check errors.
- **Search for Information Frame** only searches information frames.
 1. Enter the search string.
 2. Check **Ignore Case** to do a case-insensitive search.
 3. When you have specified the time interval you want to use, click on the **Find Next** or **Find Previous** buttons to start the search from the current event.

The result of the search is displayed in the **Decode** pane in **Frame Display**.

Side Restrictions - Side Restriction means that the analyzer looks for a pattern coming wholly from the DTE or DCE side. If you choose to search without regard for data origin, the analyzer looks for a pattern coming from one or both sides. For example, if you choose to search for the pattern ABC and you choose to search without regard for data origin, the analyzer finds all three instances of ABC shown here.

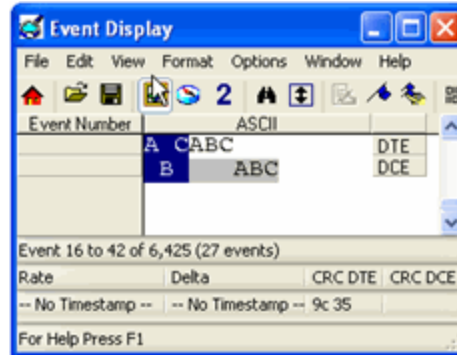

The first pattern, with the A and the C coming from the DTE device and the B coming from the DCE is a good example of how using a side restriction differs from searching without regard to data origin. While searching without regard for data origin finds all three patterns, searching using a side restriction never finds the first pattern, because it does not come wholly from one side or the other.

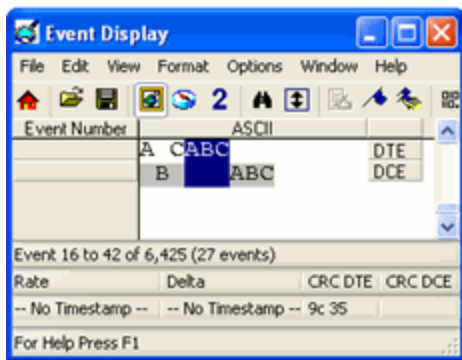

If you choose to search for the pattern ABC, and you restrict the search to just the DTE side, the analyzer finds the following pattern:

In this example, the analyzer finds only the second pattern (highlighted above) because we restricted the search to just the DTE side. The first pattern doesn't qualify because it is split between the DTE and DCE sides, and the third pattern, though whole, comes from just the DCE side.

If we choose both the DTE and the DCE sides in the above example, then the analyzer finds the second pattern followed by the third pattern, but not the first pattern. This is because each side has one instance in which the whole pattern can be found. The analyzer completely searches the DTE side first, followed by the DCE side.

Note: Side Restriction is available for pattern and error searching.



1. Select one of the two options.
2. Select **DTE**, **DCE**, or both.
3. When you made your selections, click on the **Find Next** or **Find Previous** buttons to start the search from the current event.

The result of the search is displayed in the **Decode** pane in **Frame Display**.

5.1.2 Searching by Pattern

Search by Pattern lets you perform a traditional string search. You can combine any of the formats when entering your string, and your search can include [wildcards](#).

To access the search by pattern function:

1. Open a capture file to search.
2. Open the **Event Display**  or **Frame Display**  window.

3. Click on the **Find** icon  or choose **Find** from the **Edit** menu.
4. Click on the **Pattern** tab of the **Find** dialog.

Note: The tabs displayed on the Find dialog depend on the product you are running and the content of the capture file you are viewing.

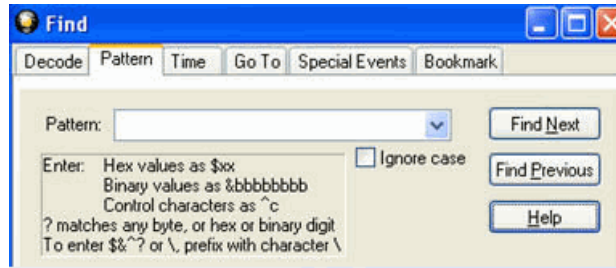

Figure 5.4 - Find Pattern Tab

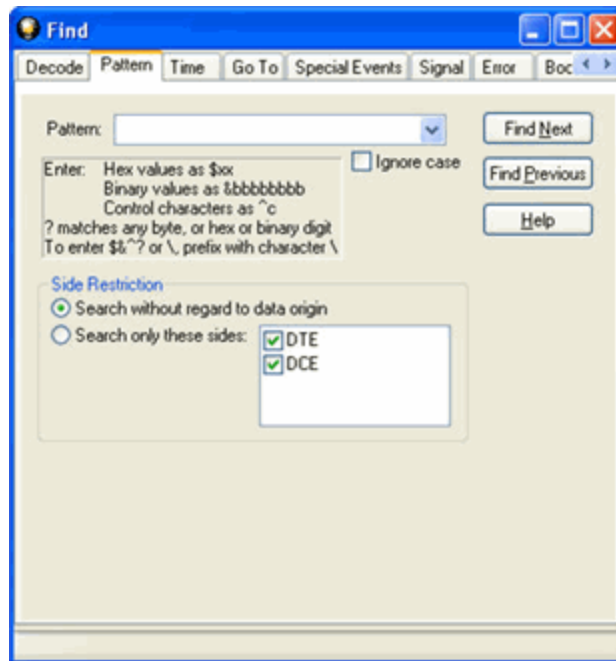

Figure 5.5 - Find Pattern Tab Side Restrictions

Pattern allows you to enter a string in the text box. You can use [characters](#), [hex or binary digits](#), [control characters](#), [wildcards](#) or a combination of any of the formats when entering your string. Every time you type in a search string, the ComProbe analyzer saves the search. The next time you open **Find**, the drop-down list will contain your search parameters.

1. Enter the search pattern.
2. Check **Ignore Case** to do a case-insensitive search.

- When you have specified the pattern you want to use, click on the **Find Next** or **Find Previous** buttons to start the search from the current event.



The result of the search is displayed in the in Frame Display and Event Display.

Refer to Searching by Decode [on page 150](#) for information on **Side Restrictions**

5.1.3 Searching by Time

Searching with **Time** allows you search on timestamps on the data in **Frame Display** and **Event Display** window.

To access the search by time function:

- Open a capture file to search.
- Open the **Event Display**  or **Frame Display**  window.
- Click on the **Find** icon  or choose **Find** from the **Edit** menu.
- Click on the **Time** tab of the **Find** dialog.

Note: The tabs displayed on the Find dialog depend on the product you are running and the content of the capture file you are viewing.

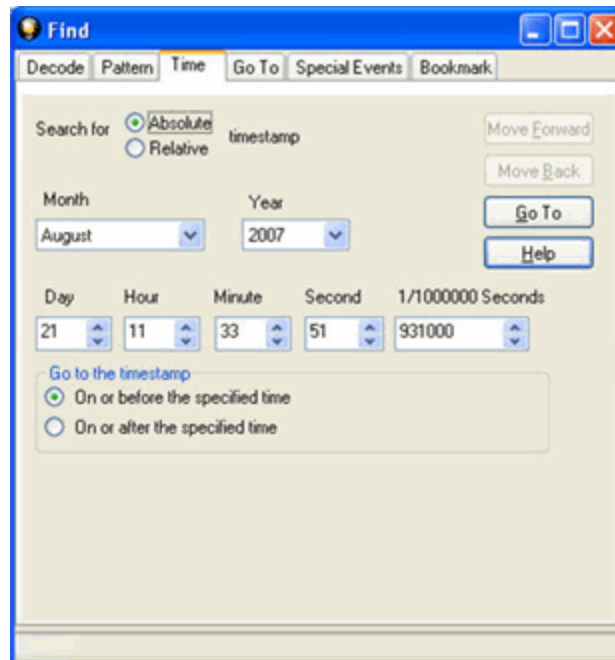

Figure 5.6 - Find by Time tab

The analyzer can search by time in several different ways.

Search for Absolute/Relative timestamp.

- [Absolute](#) - An absolute timestamp search means that the analyzer searches for an event at the exact date and time specified. If no event is found at that time, the analyzer goes to the nearest event either before or after the selected time, based on the "Go to the timestamp" selection.
- [Relative](#) - A relative search means that the analyzer begins searching from whatever event you are currently on, and search for the next event a specific amount of time away.

1. Select **Absolute** or **Relative**
2. Select the date and time using the drop-down lists for **Month, Year, Day, Hour, Minute, Second, 1/1000000**.

Note: Month and Year are not available if you select Relative.

3. When you have specified the time interval you want to use, click on the **Go To, Move Forward** or **Move Backward** buttons to start the search from the current event.

Note: When you select **Absolute** as **Search for**, **Go To** is available. When you select **Relative** as **Search for**, **Move Forward** or **Move Backward** is available.

Go to the timestamp: On or before/ On or after

The analyzer searches for an event that matches the time specified. If no event is found at the time specified, the analyzer goes to the nearest event either before or after the specified time. Choose whether to have the analyzer go to the nearest event before the specified time or after the specified time by clicking the appropriate radio button in the **Go to the timestamp** box.

If you are searching forward in the buffer, you usually want to choose the **On or After** option. If you choose the **On or Before** option, it may be that the analyzer finishes the search and not move from the current byte, if that byte happens to be the closest match.

When you select **Absolute** as **Search for**, the radio buttons are **On or before the specified time** or **On or after the specified time**. When you select **Relative** as **Search for**, the radio buttons are **On or before the specified time relative to the first selected item** or **On or after the specified time relative to the last selected item**.

1. Select **On or before the specified time** or **On or after the specified time**.
2. When you have specified the time interval you want to use, click on the **Go To, Move Forward** or **Move Backward** buttons to start the search from the current event.

When you select **Absolute** as **Search for**, **Go To** is available. When you select **Relative** as **Search for**, **Move Forward** or **Move Backward** is available.

There are a couple of other concepts to understand in respect to searching with timestamps.

- The analyzer skips some special events that do not have timestamps, such as frame markers. Data events that do not have timestamps because timestamping was turned off either before or during capture are also skipped.

- Timestamping can be turned on and off while data is being captured. As a result, the capture buffer may have some data with a timestamp, and some data without. When doing a search by timestamp, the analyzer ignores all data without a timestamp.
- The raw timestamp value is the number of 100-nanosecond intervals since the beginning of January 1, 1601. This is standard Windows time.

5.1.4 Using Go To

Searching with Go To allows you to go to a particular frame or event, or to move through the data X number of events or frames at a time. You can move either forward or backwards through the data.

To access the Go To function:

1. Open a capture file to search.
2. Open the **Event Display**  or **Frame Display**  window.
3. Click on the **Find** icon  or choose **Find** from the **Edit** menu.
4. Click on the **Go To** tab of the **Find** dialog.
5. The system displays the **Find** dialog with the **Go To** tab selected.

Note: The tabs displayed on the Find dialog depend on the product you are running and the content of the capture file you are viewing.

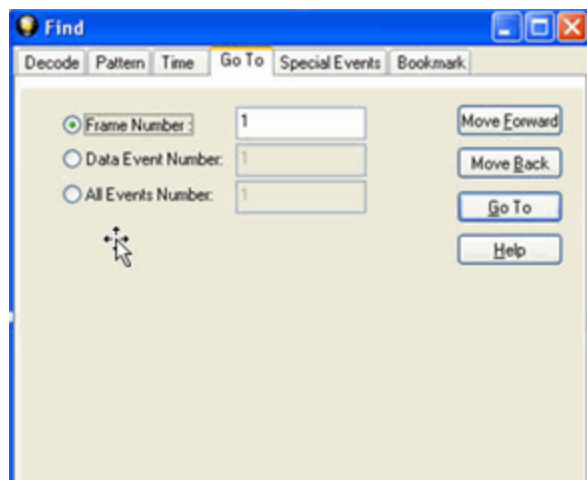

Figure 5.7 - Find Go To tab

To go to a particular frame :

1. Select the **Frame Number** radio button
2. Type the frame number in the box.
3. Click the **Go To** button.

4. To move forward or backward a set number of frames, type in the number of frames you want to move
5. Then click the **Move Forward** or **Move Back** button.

To go to a particular event :

1. Select the **Data Event Number** or **All Events Number** radio button.
2. Type the number of the event in the box.
3. Click the **Go To** button.
4. To move forward or backwards through the data, type in the number of events that you want to move each time.
5. Then click on the **Move Forward** or **Move Backward** button.
6. For example, to move forward 10 events, type the number 10 in the box, and then click on **Move Forward**. Each time you click on **Move Forward**, Frontline moves forward 10 events.



See [Event Numbering](#) for why the **Data Event Number** and **All Events Number** may be different. As a general rule, if you have the **Show All Events** icon  depressed on the **Event Display** window or **Frame**

Display Event pane, choose **All Events Number**. If the **Show All Events** button is up, choose **Data Event Number**.

5.1.5 Searching for Special Events

Frontline inserts or marks events other than data bytes in the data stream. For example, the analyzer inserts start-of-frame and end-of-frame markers into framed data, marking where each frame begins and ends. If a hardware error occurs, the analyzer shows this using a special event marker. You can use Find to locate single or multiple special events.

To access the search for special events function:

1. Open a capture file to search.
2. Open the **Event Display**  or **Frame Display**  window.
3. Click on the **Find** icon  or choose **Find** from the **Edit** menu.
4. Click on the **Special Events** tab of the Find dialog.

Note: The tabs displayed on the Find dialog depend on the product you are running and the content of the capture file you are viewing.

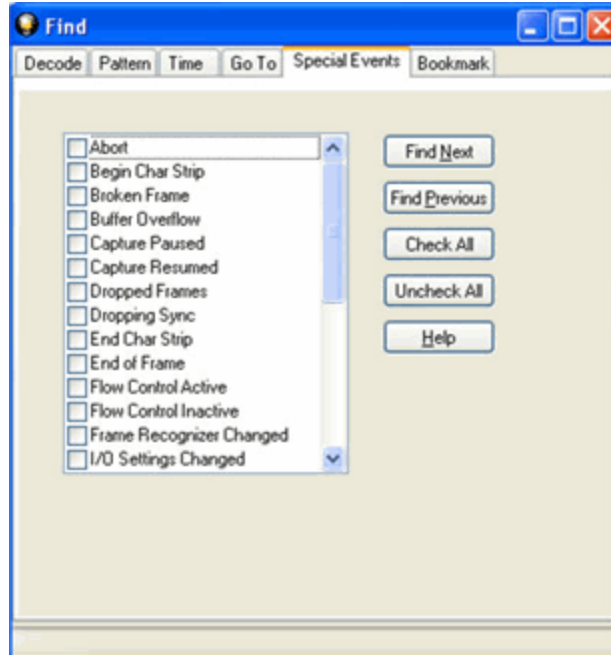

Figure 5.8 - Find Special Events tab

5. Check the event or events you want to look for in the list of special events. Use **Check All** or **Uncheck All** buttons to make your selections more efficient.
6. Click Find Next and Find Previous to move to the next instance of the event.

Not all special events are relevant to all types of data. For example, control signal changes are relevant only to serial data and not to Ethernet data.



For a list of all special events and their meanings, see [List of all Event Symbols on page 137](#).

5.1.6 Searching by Signal

Searching with Signal allows you to search for changes in control signal states for one or more control signals. You can also search for a specific state involving one or more control signals, with the option to ignore those control signals whose states you don't care about.

The analyzer takes the current selected byte as its initial condition when running searches that rely on finding events where control signals changed.

To access the search by time function:

1. Open a capture file to search.
2. Open the **Event Display**  or **Frame Display**  window.
3. Click on the **Find** icon  or choose **Find** from the **Edit** menu.
4. Click on the **Signal** tab of the **Find** dialog.

Note: The tabs displayed on the Find dialog depend on the product you are running and the content of the capture file you are viewing.

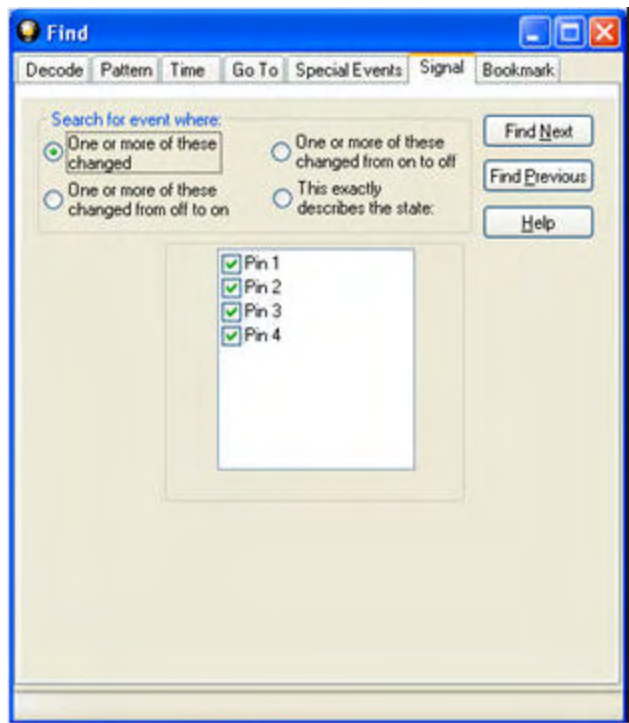

Figure 5.9 - Find Signal tab.

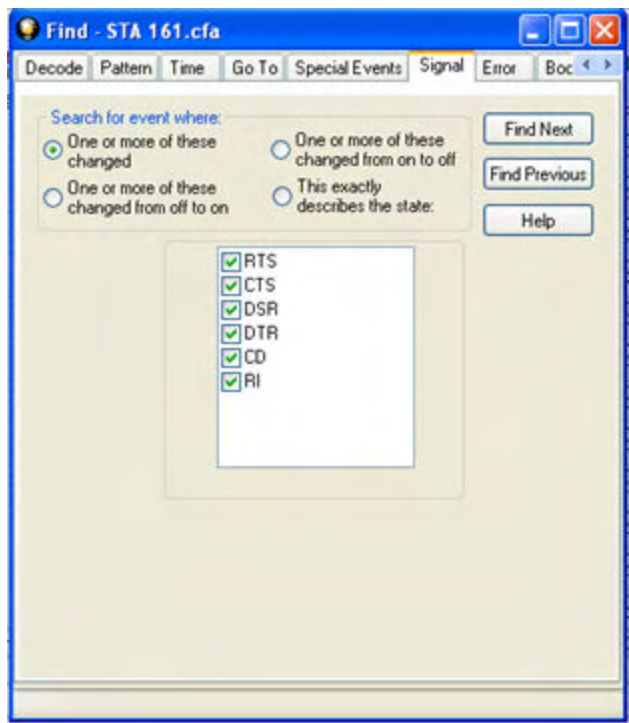

Figure 5.10 - Find Signal Tab

You will choose one qualifier—**Searching for event where**, then choose one or more control signals

Control Signals

The section with the check boxes allows you to specify which control signals the analyzer should pay attention to when doing the search. The analyzer pays attention to any control signal with a check mark.

- Click on a box to place a check mark next to a control signal
- Click again to uncheck the box
- By default, the analyzer searches all control signals, which means all boxes start out checked.

For example, if you are only interested in finding changes in **RTS** and **CTS**, you would check those two boxes and uncheck all the other boxes. This tells the analyzer to look only at the **RTS** and **CTS** lines when running the search. The other signals are ignored.

The control signals types include:

- USB - Pin 1
- USB - Pin 2
- USB - Pin 3
- USB - Pin 4

or

- RS232 - Request to Send (RTS)
- RS232 - Clear to Send (CTS)
- RS232 - Data Set Ready (DSR)
- RS232 - Data Terminal Ready (DTR)
- RS232 - Carrier Detect (CD)
- RS232 - Ring Indicator (RI).

[Click here to learn more about the Breakout Box and Pins 1 - 4.](#)

Searching for event where:

- The first three options are all fairly similar, and are described together. These options are searching for an event where:
 - One or more control signals changed
 - One or more control signals changed from off to on
 - One or more control signals changed from on to off
- Searching for an event where one or more signals changed means that the analyzer looks at every control signal that you checked, and see if any one of those signals changed state at any time.

- If you want to look at just one control signal:
 - Check the box for the signal.
 - Uncheck all the other boxes.
 - Choose to search for an event where one or more signals changed.
 - The analyzer notes the state of the selected signal at the point in the buffer where the cursor is, search the buffer, and stop when it finds an event where RTS changed state.
 - If the end of the buffer is reached before an event is found, the analyzer tells you that no matches were found.
- Searching for events where control signals changed state from off to on, or vice versa, is most useful if the signals are usually in one state, and you want to search for occasions where they changed state.

For example:

- If DTR is supposed to be on all the time but you suspect that DTR is being dropped
- Tell the analyzer to look only at DTR by checking the DTR box and unchecking the others
- Do a search for where one or more control signals changed from on to off.
- The analyzer would search the DTR signal and stop at the first event where DTR dropped from on to off.
- Searching for an Exact State



To search for an exact state means that the analyzer finds events that match exactly the state of the control signals that you specify.

- First, choose to search for an event where your choices exactly describe the state.
- This changes the normal check boxes to a series of radio buttons labeled On, Off and Don't Care for each control signal.
- Choose which state you want each control signal to be in.
- Choose Don't Care to have the analyzer ignore the state of a control signal.
- When you click Find Next, the analyzer searches for an event that exactly matches the conditions selected, beginning from the currently selected event.
- If the end of the buffer is reached before a match is found, the analyzer asks you if you want to continue searching from the beginning.
- If you want to be sure to search the entire buffer, place your cursor on the first event in the buffer.
- Select one of the four radio buttons to choose the condition that must be met in the search
- Select one or more of the checkboxes for Pin 1, 2, 3, or 4.
- Or, **Select one or more of the** checkboxes for Request to Send (**RTS**), Clear to Send (**CTS**), Data Set Ready (**DSR**), Data Terminal Ready (**DTR**), Carrier Detect (**CD**), and Ring Indicator (**RI**).
- Click **Find Next** to locate the next occurrence of the search criteria or **Find Previous** to locate an earlier occurrence of the search criteria.

5.1.7 Searching for Data Errors

The analyzer can search for several types of data errors. Searching for data error allows you to choose which errors you want to search for and whether to search the DTE or DCE data or both. Bytes with errors are shown in red in the **Event Display** window, making it easy to find errors visually when looking through the data.

To access the search by time function:

1. Open a capture file to search.
2. Open the **Event Display**  or **Frame Display**  window.
3. Click on the **Find** icon  or choose **Find** from the **Edit** menu.
4. Click on the **Errors** tab of the **Find** dialog.

Note: The tabs displayed on the Find dialog depend on the product you are running and the content of the capture file you are viewing.

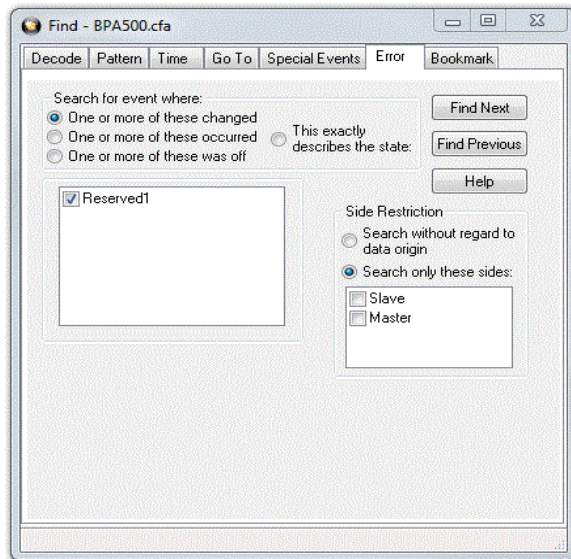

Figure 5.11 - Find Error tab.

Searching for event where

The first three options are all fairly similar, and are described together. These options are searching for an event where:

- one or more error conditions changed
- one or more error conditions occurred
- one or more error conditions were off (i.e. no errors occurred)

Selecting Which Errors to Search

The section with the check boxes allows you to choose which errors the analyzer should look for. Click on a box to check or un-check it.

If you want to search only for overrun errors

- check the box if shown
- un-check the other boxes.

To search for all types of errors

- check all boxes

The most common search is looking for a few scattered errors in otherwise clean data.

To do this type of search:

- choose to **Search for an event where** one or more error conditions occurred
- choose which errors to look for
- By default, the analyzer looks for all types of errors.

In contrast, searching for an event where one or more error conditions were off means that the analyzer looks for an event where the errors were not present.

For example, if you have data that is full of framing errors, and you know that somewhere in your 20 megabyte capture file the framing got straightened out, you could choose to search for an event where one or more error conditions were off, and choose to search only for framing. The analyzer searches the file, and finds the point at which framing errors stopped occurring.

Searching for an event where the error conditions changed means that the analyzer searches the data and stop at every point where the error condition changed from on to off, or off to on.

For example, if you have data where sometimes the framing is wrong and sometimes right, you would choose to search framing errors where the error condition changed. This first takes you to the point where the framing errors stopped occurring. When you click **Find Next**, the analyzer stops at the point when the errors began occurring again. Clicking **Find Previous** will search backwards from the current position.

The analyzer takes the current selected byte as its initial condition when running searches that rely on finding events where error conditions changed. The analyzer searches until it finds an event where error conditions changed or it reaches the end of the buffer, at which point the analyzer tells you that there are no more events found in the buffer. If you are searching for an exact match, the analyzer asks you if you want to continue searching from the beginning of the buffer.

Searching for Exact Error Conditions

To search for an exact state means that the analyzer finds events that exactly match the error conditions that you specify.

- Select the **This exactly describes the state** radio button.
- This changes the normal check boxes to a series of radio buttons labeled **On**, **Off** and **Don't Care** for each error.
 - **On** means that the error occurred
 - **Off** means that the error did not occur
 - **Don't Care** means that the analyzer ignores that error condition.
- Select the appropriate state for each type of error.

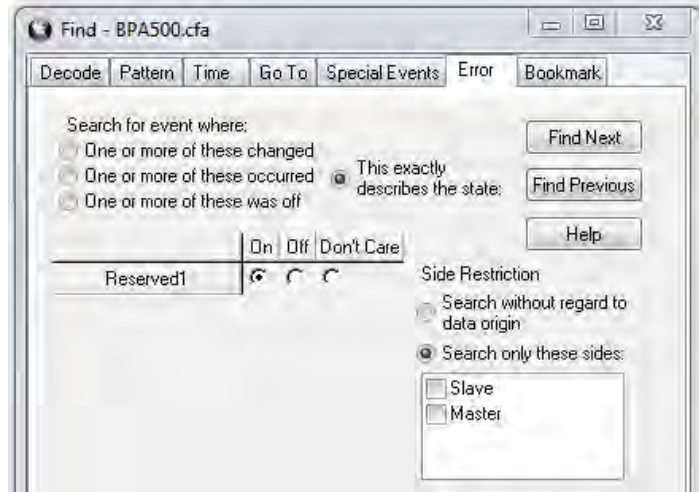

Example:

If you need to find an event where just an overrun error occurred, but not any other type of error, you would choose overrun error to be On, and set all other errors to Off. This causes the analyzer to look for an event where only an overrun error occurred.



If you want to look for events where overrun errors occurred, and other errors may have also occurred but it really doesn't matter if they did or not, choose overrun to be On, and set the others to Don't Care. The analyzer ignores any other type of error, and find events where overrun errors occurred.

To find the next error, click the Find Next button. To find an error that occurred earlier in the buffer to where you are, click the Find Previous button.

5.1.8 Find - Bookmarks

Searching with **Bookmarks** allows you search on specific [bookmarks](#) on the data in **Frame Display** and **Event Display** window. Bookmarks are notes/reminders of interest that you attach to the data so they can be accessed later.

To access the search for bookmarks

1. Open a capture file to search.
2. Open the **Event Display**  or **Frame Display**  window.
3. Click on the **Find** icon  or choose **Find** from the **Edit** menu.
4. Click on the **Bookmarks** tab of the **Find** dialog.

Note: The tabs displayed on the Find dialog depend on the product you are running and the content of the capture file you are viewing.

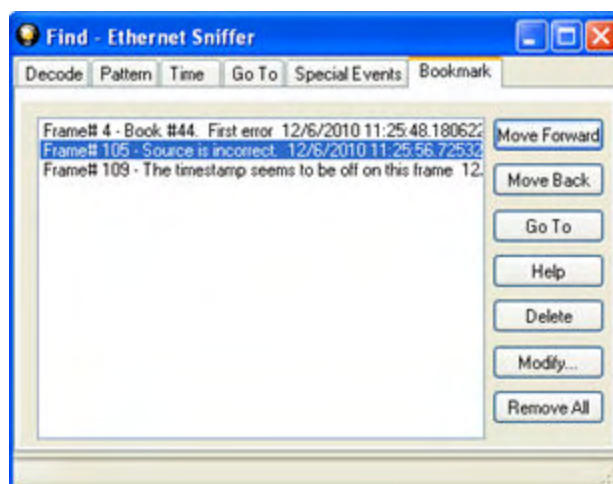



Figure 5.12 - Find Bookmark tab.

There are several ways to locate bookmarks.

- Select the bookmark you want to move to and click the **Go To** button.
- Simply double-click on the bookmark.
- Click the **Move Forward** and **Move Back** buttons to move through the frames to the bookmarks shown in the window. When the bookmark is found it is highlighted in the window.

There are three ways to modify bookmarks:

1. Click on **Delete** to remove the selected bookmark.
2. Click on **Modify...** to change the selected Bookmark name.
3. **Remove All** will delete all bookmarks in the window.

The **Find** window **Bookmark** tab will also appear when using functions other than **Find** such as when clicking on the Display All Bookmarks  icon.

5.1.9 Changing Where the Search Lands

When doing a search in the analyzer, the byte or bytes matching the search criteria are highlighted in the **Event Display**. The first selected byte appears on the third line of the display.

```
[CVEventDisplay]
SelectionOffset=2
```

To change the line on which the first selected byte appears:

1. Open fts.ini (located in the C:\User\Public\Public Documents\Frontline Test Equipment\)
2. Go to the [CVEventDisplay] section
3. Change the value for SelectionOffset.
4. If you want the selection to land on the top line of the display, change the SelectionOffset to 0 (zero).

5.1.10 Subtleties of Timestamp Searching

Timestamping can be turned on and off while data is being captured. As a result, the capture buffer may have some data with a timestamp, and some data without. When doing a search by timestamp, the analyzer ignores all data without a timestamp.

Note: The raw timestamp value is the number of 100-nanosecond intervals since the beginning of January 1, 1601. This is standard Windows time.

5.2 Bookmarks

Bookmarks are electronic sticky notes that you attach to frames of interest so they can be easily found later. In **Frame Display** bookmarked frames appear with a magenta triangle icon next to them.



B...	Frame#	Command	Error Code	FID	MID	PID	Source	TID	UID	Fra...	Delta	Timestamp
	1									64		12/6/2010 11:25...
	2									168	00:00:00.0...	12/6/2010 11:25...
	E 3									124	00:00:00.3...	12/6/2010 11:25...
	4									64	00:00:00.1...	12/6/2010 11:25...

Figure 5.13 - Bookmarked Frame (3) in the Frame Display

```
00 00 00 00 00
21 M [E] 00 15
00 45 00 00 47
?? ? ? ? ?
```

In the **Event Display** bookmarks appear as a dashed line around the start of frame marker.

Bookmarks are easy to create and maintain, and are a very valuable tool for data analysis.

When you [create](#) or [modify](#) a bookmark, you have up to 84 characters to explain a problem, leave yourself a reminder, leave someone else a reminder, etc. Once you create a bookmark it will be saved with the rest of the data in the [.cfa file](#). When you open a .cfa file, the bookmarks are available to you.

Once you have created a bookmark, you can use the [Find](#) function or other navigation methods to [locate and move](#) among them.

5.2.1 Adding, Modifying or Deleting a Bookmark



You can add, modify, or delete a bookmarks from **Frame Display** and **Event Display**

Add:



1. Select the frame or event you want to bookmark.
2. There are three ways to access the **Add Bookmark** dialog.
 - a. Select **Add or Modify Bookmark** from the **Bookmarks** menu on the **Frame Display** and **Event Display**,
 - b. Select the **Add or Modify Bookmark**  icon on one of the toolbars, or
 - c. Right-click on the frame/event and choosing **Add Bookmark...**
3. In the dialog box, add a comment (up to 84 characters) in the text box to identify the bookmark.
4. Click **OK**.

Once you create a bookmark it will be saved with the rest of the data in the [.cfa file](#). When you open a .cfa file, the bookmarks are available to you.

Modify

1. Select the frame or event with the bookmark to be edited.
2. There are three ways to access the **Add/Modfy Bookmark** dialog.
 - a. Select **Add or Modify Bookmark** from the **Bookmarks** menu on the **Frame Display** and **Event Display**
 - b. Select the **Add or Modify Bookmark**  icon on one of the toolbars, or
 - c. Right-click on the frame/event and choosing **Modify Bookmark...** on the selection.
3. Change the comment in the dialog box
4. Click **OK**. The edited bookmark will be saved as a part of the [.cfa file](#).
5. You can also select **Display All Bookmarks**  from the **Frame Display** and **Event Display** toolbar or the **Bookmarks** menu. the **Find** window will open on the **Bookmark** tab. Select the bookmark you want to modify and click the **Modify...** button. Change the comment in the dialog box, and click **OK**.

Delete

1. Select the frame or event with the bookmark to be deleted.
2. There are three ways to access the **Add/Modfy Bookmark** dialog.
 - a. Select **Add or Modify Bookmark** from the **Bookmarks** menu on the **Frame Display** and **Event Display**,
 - b. Select the **Add or Modify Bookmark**  icon on one of the toolbars, or
 - c. Right-click on the frame/event and choosing **Modify Bookmark...** on the selection.
3. Click on the **Delete** button. The bookmark will be deleted.
4. You can also select **Display All Bookmarks**  from the **Frame Display** and **Event Display** toolbar or the **Bookmarks** menu. the **Find** window will open on the **Bookmark** tab. Select the bookmark you want to delete and click the **Delete** button.

5.2.2 Displaying All and Moving Between Bookmarks

There are three ways to move between bookmarks.

1. Press the F2 key to move to the next frame or event with a bookmark.
2. Select Go to Next Bookmark from the Bookmarks menu.
3. Click the Display All Bookmarks icon  . Select the bookmark you want to move to and click the Go To button, or simply double-click on the bookmark. Click the Move Forward and Move Back buttons to cycle through the bookmarks.

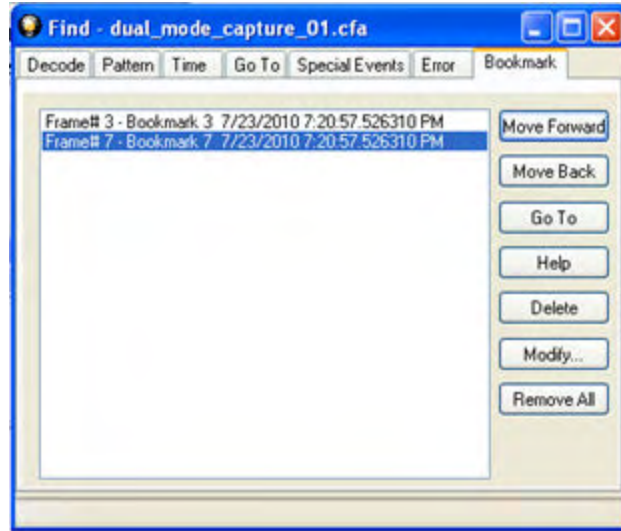

Figure 5.14 - Find Window Bookmark tab Used to Move Around With Bookmarks

To delete a bookmark, select it and click the **Delete** button.

To modify a bookmark, select it and click the **Modify** button.

Click **Remove All** to delete all the bookmarks.

Chapter 6 Saving and Importing Data

6.1 Saving Your Data





You can save all or part of the data that you have captured. You can also load a previously saved capture file, and save a portion of that file to another file. This feature is useful if someone else needs to see only a portion of the data in your capture file.

On the **Control** window toolbar you can set up to capture a single file. [Click here to see those settings.](#)

There are two ways to save portions or all of the data collected during a data capture. [Click here to see how to capture data to disk.](#)

6.1.1 Saving the Entire Capture File

This option is only available when you select **Single File** from the **Capture Mode** on **System Settings**. [Click here to learn more about selecting Save options from System Settings.](#)

1. If you are capturing data, click on the **Stop Capture**  icon to stop data capture. You cannot save data to file while it is being captured.
2. Open the **Event Display**  or **Frame Display**  window.
3. Click the **Save**  icon, or select **Save** from the **File** menu.

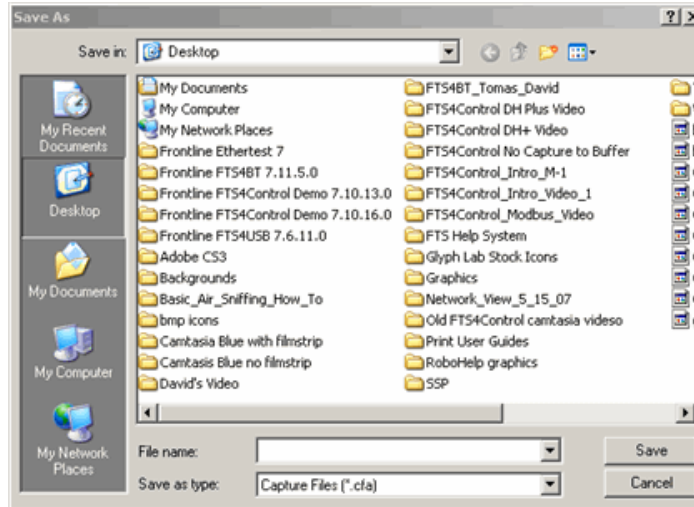



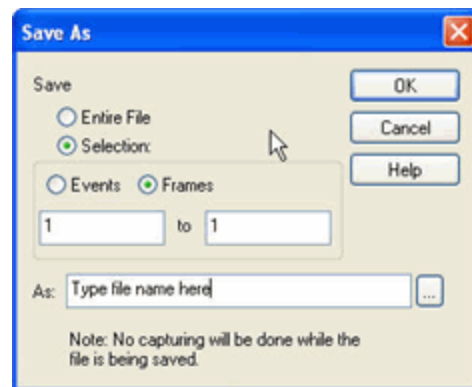

Figure 6.1 - Windows Save dialog



4. Type a file name in the **File name** box at the bottom of the screen.
5. Browse to select a specific directory. Otherwise your file is saved in the default capture file directory.
6. When you are finished, click **OK**.

6.1.2 Saving the Entire Capture File with Save Selection

1. If you are capturing data, click on the **Stop** icon  to stop data capture. You cannot save data to file while it is being captured.
2. Open the **Event Display**  or **Frame Display**  window.
3. Right click in the data
4. Select **Save Selection** or **Save As** from the right click menu.
5. Click on the radio button labeled **Entire File**.
6. Choose to save **Events** or **Frames** . Choosing to save **Events** saves the entire contents of the capture file. Choosing to save **Frames** does not save all events in the capture file.
7. Type a file name in the **As** box at the bottom of the screen. Click the **Browse** icon to browse to a specific directory. Otherwise your file is saved in the default capture file directory.
8. When you are finished, click **OK**.



6.1.3 Saving a Portion of a Capture File

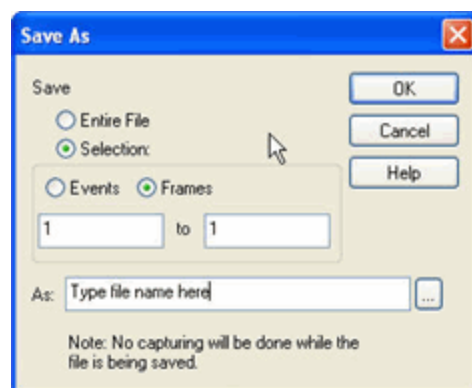

1. If you are capturing data, click on the **Stop** icon  to pause data capture. You cannot save data to a file while it is being captured.
2. Open the **Event Display**  or **Frame Display**  window, depending on whether you want to specify a range in bytes or in frames.
3. Select the portion of the data that you want to save. Click and drag to select data, or click on the first item, move to the last item and Shift+Click to select the entire range, or use the Shift key with the keyboard arrows or the navigation icons in the **Frame Display** toolbar. If the range you want to save is too large to select, note the numbers of the first and last item in the range.
4. Right click in the data
5. Select **Save Selection** or **Save As** from the right click menu
6. Click on the radio button labeled **Selection**. If you selected a range, make sure the starting and ending numbers are correct. To specify a range, type the numbers of the first and last items in the range in the boxes.
7. Select either **Events** or **Frames** to indicate whether the numbers are event or frame numbers.
8. Type a file name in the **As** box at the bottom of the screen. Click the **Browse** icon to browse to a specific directory. Otherwise your file is saved in the default capture file directory.
9. Click **OK** when you are finished.





6.2 Adding Comments to a Capture File

The **Notes** feature allows you to add comments to a CFA file. These comments can be used for many purposes. For example, you can list the setup used to create the capture file, record why the file is useful to keep, or include notes to another person detailing which frames to look at and why. ([Bookmarks](#) are another useful way to record information about individual frames.)

To open the **Notes** window :

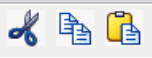
1. Click the **Show Notes** icon . This icon is present on the toolbars of the **Frame Display** , as well as the **Event Display** . **Notes** can be selected from the **Edit** menu on one of these windows.

2. Type your comments in the large edit box on the **Notes** window. The **Cut, Copy, Paste** features are supported from **Edit** menu and the toolbar  when text is selected. Undo and Redo features are all supported from **Edit** menu and the toolbar  at the current cursor location.
3. Click the thumbtack icon  to keep the **Notes** window on top of any other windows.
4. When you're done adding comments, close the window.
5. When you close the capture file, you are asked to confirm the changes to the capture file. See [Confirming Capture File \(CFA\) Changes](#) for more information.

6.3 Confirm Capture File (CFA) Changes

This dialog appears when you close a capture file after changing the [Notes](#), the protocol stack, or [bookmarks](#). The dialog lists information that was added or changed and allows you to select which information to save, and whether to save it to the current file or to a new one.

Changes made to the file appear in a list in the left pane. You can click on each item to see details in the right pane about what was changed for each item. You simply check the boxes next to the changes you want to keep. Once you decide what changes to keep, select one of the following:

- **Save To This File** – Saves the changes you have made to the current capture file.
- **Save As** – Saves the changes to a new file.
- **Cancel the Close Operation** – Closes the file and returns you back to the display. No changes are saved.
- **Discard Changes** – Closes the file without saving any of the changes made to the notes, bookmarks, or protocol stack.

6.4 Loading and Importing a Capture File

6.4.1 Loading a Capture File

From the Control Window:

1. Go to the **File** menu.
2. Choose a file from the recently used file list.
3. If the file is not in the **File** menu list, select **Open Capture File** from the **File** menu or simply click on the **Open** icon  on the toolbar.
4. Capture files have a .cfa extension. Browse if necessary to find your capture file.
5. Click on your file, and then click **Open**.

6.4.2 Importing Capture Files

1. From the **Control** window , go to the **File** menu and select Open Capture File or click on the Open icon on the toolbar.
2. Left of the **File name** text box, select from the drop-down list **Supported File Types** box to **All Importable File Types** or **All Supported File Types (*.cfa, *.log, *.txt, *.csv, *.cap)**. Select the file and click **Open**.

The analyzer automatically converts the file to the analyzer's format while keeping the original file in its original format. You can [save the file](#) in the analyzer's format, close the file without saving it in the analyzer's format, or have the analyzer automatically save the file in the analyzer's format (see the [System Settings](#) to set this option). All of these options keep your original file untouched.

When you first open the file, the analyzer brings up the [Protocol Stack](#) window and ask you what protocol decodes, if any, you want to use. You must choose a protocol decode at this point for the analyzer to decode the data in the file. If you open a file without using any decodes, and decide later that you want to apply a decode, choose [Reframe](#) from the File menu on the Control window.

At present, the analyzer supports the following file types:

- Frontline Serialtest* Async and Serialtest ComProbe® for DOS – requires the .byt for data and the .tim for timestamps (see note on importing [DOS timestamps](#)).
- Greenleaf ViewComm* 3.0 for DOS - requires the .byt for data and the .tim for timestamps (see note on importing [DOS timestamps](#)).
- Frontline Ethertest* for DOS – requires 3 files: filename.cap, filename.ca0 and filename.ca1.
- Sniffer Type 1 – supports files with the .enc extension. Does not support Sniffer files with a .cap extension.
- Snoop or Sun Snoop – files with a .cap extension based on RFC 1761. For file format, see <http://www.faqs.org/rfcs/rfc1761.html>.
- Shomiti Surveyor files in Snoop format – files with a .cap extension. For file format, contact [Technical Support](#).
- CATC Merlin - files with a .csv extension. Files must be exported with a specific format. See [File Format for Merlin Files](#) for information.
- CATC Chief - files with a .txt extension.

6.5 Printing

6.5.1 Printing from the Frame Display/HTML Export

The **Frame Display Print** dialog and the **Frame Display HTML Export** are very similar. This topic discusses both dialogs.

Frame Display Print

The **Frame Display Print** feature provides the user with the option to print the capture buffer or the current selection. The maximum file size, however, that can be exported is 1000 frames.

When **Print Preview** is selected, the output displays in a browser print preview window, where the user can select from the standard print options. The output file format is in html, and uses the Microsoft Web Browser Control print options for background colors and images.

Print Background Colors Using Internet Explorer

1. Open the Tools menu on the browser menu bar
2. Select “Internet Options...” menu entry.
3. Click Advanced tab.
4. Check “Print background colors and images” under the Printing section
5. Click the Apply button, then click OK

Configure the Print File Range in the Frame Display Print Dialog

Selecting more than one frame in the Frame Display window defaults the radio button in the Frame Display Print dialog to Selection and allows the user to choose the All radio button. When only one frame is selected, the All radio button in the Frame Display Print dialog is selected.

How to Print Frame Display Data

1. Select **Print** or **Print Preview** from the **File** menu on the **Frame Display** window to display the **Frame Display Print** dialog. Select **Print** if you just want to print your data to your default printer. Select **Print Preview** if you want access to printer options.
2. Choose to include the **Summary** pane (check the box) in the print output. The **Summary** pane appears at the beginning of the printed output in tabular format. If you select **All layers** in the **Detail Section**, the **Data Bytes** option becomes available.
3. In the **Detail Section**, choose to exclude—**No decode section**—the decode from the **Detail** pane in the **Frame Display**, or include **All Layers** or **Selected Layers Only**. If you choose to include selected layers, then select (click on and highlight) the layers from the list box.
4. Click on selected layers in the list to de-select, or click the **Reset Selected Layers** button to de-select all selected layers.

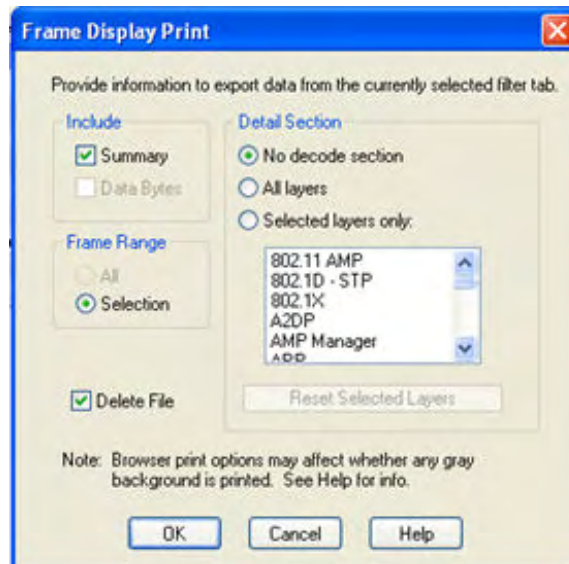

Figure 6.2 - Frame Display Print Dialog

5. Select the range of frames to include **All** or **Selection** in the **Frame Range** section of the **Frame Display Print** dialog.

Choosing **All** prints up to 1000 frames from the buffer.

Choosing **Selection** prints only the frames you select in the Frame Display window.

6. Selecting the **Delete File** deletes the temporary html file that was used during printing
7. Click the **OK** button.

Frame Display Print Preview

The **Frame Display Print Preview** feature provides the user with the option to export the capture buffer to an .html file. The maximum file size, however, that can be exported is 1000 frames.

If you chose **Print Preview**, the system displays your data in a browser print preview display with options for printing such as page orientation and paper size. You can also use your Printer Preferences dialog to make some of these selections. When printing your data, the analyzer creates an html file and prints the path to the file at the bottom of the page. This file can be opened in your browser, however, it may appear different than the printed version.

1. Select **Print Preview** from the **File** menu on the **Frame Display** window to display the **Frame Display Print Preview**.

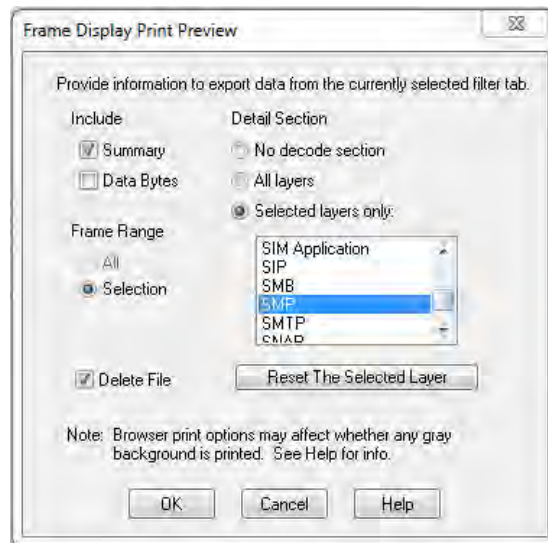

Figure 6.3 - Frame Display Print Preview Dialog

2. From this point the procedure is the same as steps 2 through 5 in "How to Print Frame Display Data" above.
3. Click the **OK** button, and after a brief wait a browser window will appear.

6.5.2 Printing from the Event Display

The Event Display Print feature provides the user with the option to print either the entire capture buffer or the current selection. When Print Preview is selected, the output displays in a browser print preview window where the user can select from the standard print options. The output file format is in html, and uses the Microsoft Web Browser Control print options for background colors and images (see below).

Print Background Colors Using Internet Explorer

1. Open the Tools menu on the browser menu bar
2. Select "Internet Options..." menu entry.
3. Click Advanced tab.
4. Check "Print background colors and images" under the Printing section
5. Click the Apply button, then click OK

The **Event Display Print** feature uses the current format of the **Event Display** as specified by the user.

See [About Event Display](#) for an explanation on formatting the **Event Display** prior to initiating the print feature.

Configure the Print File Range in the Event Display Print dialog

Selecting more than one event in the **Event Display** window defaults the radio button in the **Event Display Print** dialog to **Selection** and allows the user to choose the **All** radio button. When only one event is selected, the **All** radio button in the **Event Display Print** dialog is selected.

How to Print Event Display Data to a Browser

1. Select **Print** or **Print Preview** from the **File** menu on the **Event Display** window to display the **Event Display Print** dialog. Select **Print** if you just want to print your data to your default printer. Select **Print Preview** if you want preview the print in your browser.
2. Select the range of events to include from either **All** or **Selection** in the **Event Range** section. Choosing **All** prints all of the events in the capture file or buffer. Choosing **Selection** prints only the selected events in the Event Display window.

Note: In order to prevent a Print crash, you cannot select **All** if there are more than 100,000 events in the capture buffer.

Note: See "Configure the Print File Range in the Event Display Print Dialog" above for an explanation of these selections

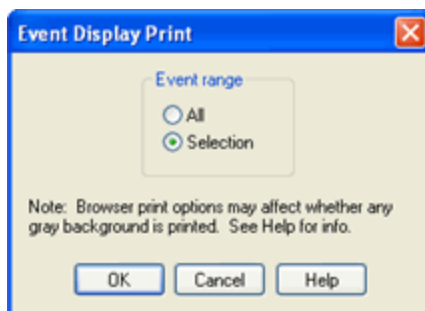

Figure 6.4 - Event Display Print Dialog

3. Click the OK button.

If you chose **Print Preview**, the system displays your data in a browser print preview display with options for printing such as page orientation and paper size. You can also use your Printer Preferences dialog to make some of these selections. When printing your data, the analyzer creates an html file and prints the path to the file at the bottom of the page. This file can be opened in your browser, however, it may appear different than the printed version.

6.6 Exporting

6.6.1 Frame Display Export

You can dump the contents of the **Summary** pane on the **Frame Display** into a Comma Separated File (.csv).

To access this feature:

1. Right click on the **Summary** pane or open the **Frame Display File** menu.
2. Select the **Export...** menu item.
3. Select a storage location and enter a **File name**.
4. Select **Save**.

6.6.2 Exporting a File with Event Display Export

With the **Event Display Export** dialog you can export the contents of the **Event Display** dialog as a text (.txt), CSV (.csv), HTML (.htm), or Binary File (.bin). You also have the option of exporting the entire capture buffer or just the current selection of the Event Display dialog.



Figure 6.5 - Event Display Export Example: .csv file.

How to Export Event Display Data to a File

1. Select **Export Events** from the **File** menu on the **Event Display** window to display the **Event Display Export** dialog.
2. Enter a file path and name, or click the browser button to display the Windows **Save As** dialog and navigate to the desired storage location.
3. Select a file type from the **Save as type:** drop-down List Menu on the Event Display Export dialog. Select from among the following file formats:

Text File (*.txt)

CSV File (*.csv)

HTML File (*.html)

Binary File (*.bin)

4. Select the range of events to include in the file from either **All** or **Selection** in the **Event Range** section of the **Event Display Export** dialog.
 - Selecting more than one event in the Event Display window defaults the radio button in the Event Display Export dialog to Selection and allows the user to choose the All radio button.
 - When only one event is selected (something must be selected), the All radio button in the Event Display Export dialog is selected by default.
5. Next you need to select the Side variable for serial communications.
 - is used to determine whether you want to export data from , or both.
 - Choose Host, Function\Control or Both to determine how you want to export the data.
5. Choose Host, Function\Control or Both to determine how you want to export the data.
6. Choose whether you want to display multiple events or single events per row.

Events Per Row: You can choose to display **Multiple Events Per Row**, but this method contains no timestamps. If you select **One Event Per Row**, you can display timestamps. multiple events or single events per row.

Note: The raw timestamp value is the number of 100-nanosecond intervals since the beginning of January 1, 1601. This is standard Windows time.

The timestamp data types displayed in columns for One Event Per Row.

Timestamp

Delta

Event Number

Byte Number

Frame Number

Type

Hex

Dec

Oct

Bin

Side

ASCII | 7-bit ASCII | EBCDIC | Baudot

RTS

CTS

DSR

DTR

CD

RI

UART Overrun

Parity Error

Framing Error

7. If you select .csv as the file type, choose whether you want to hide/display **Preambles** or **Column Headings** in the exported file
8. Click **Save**. The Event Display Export file is saved to the locations you specified in **File name**.

1	Timestamp	Delta	Event Number	Byte Number	Frame Number	Type	Hex	Dec	Oct	Bin	ASCII
632	11/30/2012 12:20:02.895166 PM	0:00:00.00	631	626	3	Data	0	0	0	0	.
633	11/30/2012 12:20:02.895166 PM	0:00:00.00	632	627	3	Data	0	0	0	0	.
634	11/30/2012 12:20:02.895166 PM	0:00:00.00	633	628	3	Data	0	0	0	0	.
635	11/30/2012 12:20:02.895166 PM	0:00:00.00	634	629	3	Data	98	152	230	10011000	.
636	11/30/2012 12:20:02.895166 PM	0:00:00.00	635	630	3	Data	70	112	160	11100000	p
637	11/30/2012 12:20:02.895166 PM	0:00:00.00	636	631	3	Data	94	148	224	10010100	.
638	11/30/2012 12:20:02.895166 PM	0:00:00.00	637	632	3	Data	22	34	42	100010	"
639	11/30/2012 12:20:02.895166 PM	0:00:00.00	638	633	3	Data	21	33	41	100001	!
640	11/30/2012 12:20:02.895166 PM	0:00:00.00	639	634	3	Data	1c	28	34	11100	.
641	11/30/2012 12:20:02.895166 PM	0:00:00.00	640	635	3	Data	80	128	200	10000000	.
642	11/30/2012 12:20:02.895166 PM	0:00:00.00	641	636	3	Data	80	128	200	10000000	.
643	11/30/2012 12:20:02.895166 PM	0:00:00.00	642	637	3	Data	80	128	200	10000000	.
644	11/30/2012 12:20:02.895166 PM	0:00:00.00	643	638	3	Data	80	128	200	10000000	.

Figure 6.6 - Example: .csv Event Display Export, Excel spreadsheet

6.6.2.1 Export Filter Out

You can filter out data you don't want or need in your text file.

(This option is available only for serial data.) In the **Filter Out** box, choose which side to filter out: the DTE data, the DCE data or neither side (don't filter any data.) For example, if you choose the radio button for DTE data, the DTE data would be filtered out of your export file and the file would contain only the DCE data.

You can also filter out Special Events (which is everything that is not a data byte, such as control signal changes and Set I/O events), Non-printable characters or both. If you choose to filter out Special Events, your export file would contain only the data bytes. Filtering out the non-printable characters means that your export file would contain only special events and data bytes classified as printable. In ASCII, printable characters are those with hex values between \$20 and \$7e.

6.6.2.2 Exporting Baudot

When exporting Baudot, you need to be able to determine the state of the shift character. In a text export, the state of the shift bit can be determined by the data in the Character field. When letters is active, the character field shows letters and vice versa.

Chapter 7 General Information

7.1 System Settings and Program Options

7.1.1 System Settings

Open the **System Settings** window by choosing **System Settings** from the **Options** menu on the **Control** window. To enable a setting, click in the box next to the setting to place a checkmark in the box. To disable a setting, click in the box to remove the checkmark. When viewing a capture file, settings related to data capture are grayed out.

Single File

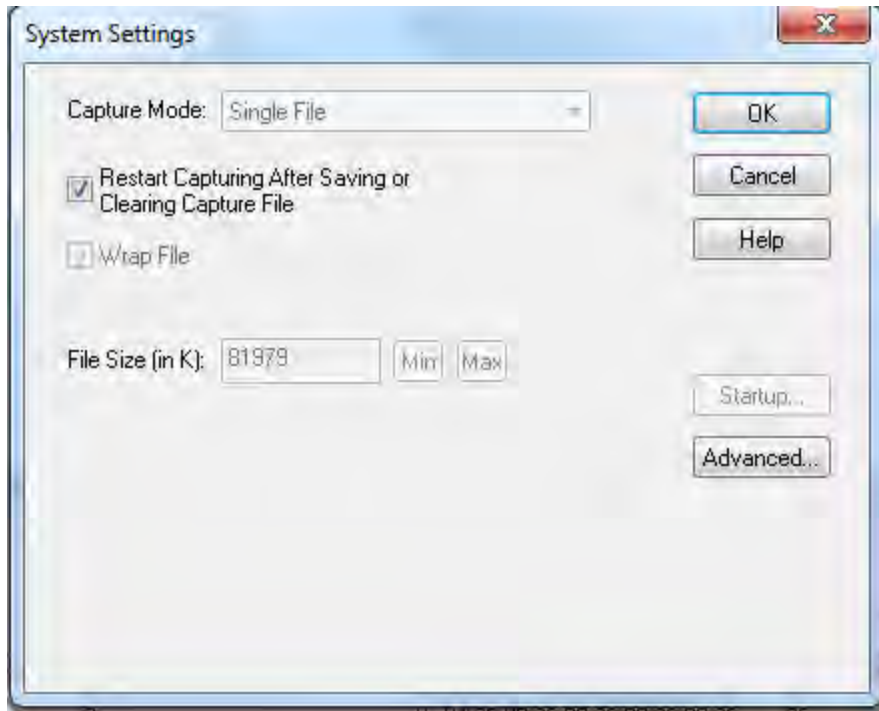

Figure 7.1 - System Settings Single File Mode

This option allows the analyzer to capture data to a file. Each time you capture the file you must provide a file name. The size of each file cannot larger than the number given in File Size (in K). The name of each file is the name you give it in the Name box followed by the date and time. The date and time are when the series was opened.

- **Restart Capturing After Saving or Clearing Capture File**

If the Automatically Restart feature is enabled, the analyzer restarts capture to the file immediately after the file is closed.

- **Wrap File**

When enabled, the analyzer wraps the file when it becomes full. The oldest events are moved out of the file to make room for new events. Any events moved out of the file are lost. When disabled, the analyzer stops capture when the file becomes full. Either reset the file or close your capture file to continue.

- **File Size:** The size of the file will depend of the available hard disk space.

1. Click the **Min** button to see/set the minimum acceptable value for the file size.
2. Click the **Max** button to see/set the maximum acceptable value for the file size.



You can accept these values, or you can enter a unique file size. But if you try to close the dialog after entering a value greater than the maximum or less than the minimum, you will see the following dialog.

- **Start up**

Opens the [Program Start up Options](#) window. **Start up** options let you choose whether to start data capture immediately on opening the analyzer.

- **Advanced**

Opens the [Advanced System Options](#) window. The Advanced Settings should only be changed on advice of technical support.

7.1.1.1 System Settings - Disabled/Enabled Options

Some of the **System Settings** options are disabled depending upon the status of the data capture session.

- As the default, all the options on the **System Settings** dialog are enabled.
- Once the user begins to capture data by selecting the Start Capture button, some of the options on the [System Settings](#) dialog are disabled until the user stops data capture and either saves or erases the captured data.
- The user can go into the [Startup options](#) and [Advanced system options](#) on the **System Settings** dialog and make changes to the settings at any time.

7.1.1.2 Advanced System Options

These parameters affect fundamental aspects of the software, and it is unlikely that you ever have to change them. If you do change them and need to return them to their original values, the default value is listed in parentheses to the right of the value box.

Most technical support problems are not related to these parameters, and as changing them could have serious consequences for the performance of the analyzer, we strongly recommend contacting technical support before changing any of these parameters.

To access the Advanced System Options:

1. Go to the Control  window.
2. Choose **System Settings** from the **Options** menu.
3. On the **System Settings** window, click the **Advanced** button.

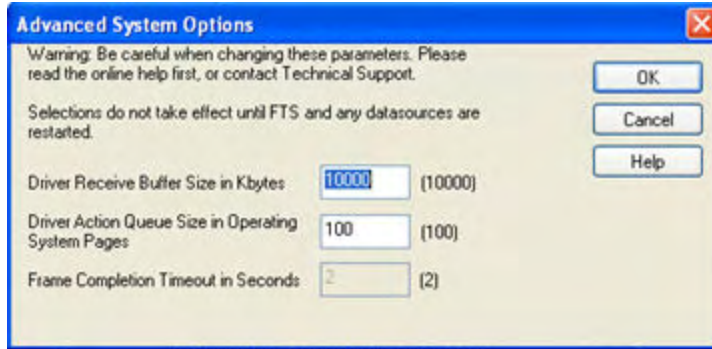

Figure 7.2 - Advanced System Options dialog

- **Driver Receive Buffer Size in Kbytes** - This is the size of the buffer used by the driver to store incoming data. This value is expressed in Kbytes.
- **Driver Action Queue Size In Operating System Pages** - This is the size of the buffer used by the driver to store data to be transmitted. This value is expressed in operating system pages.
- **Frame Completion Timeout in Seconds** - This is the number of seconds that the analyzer waits to receive data on a side while in the midst of receiving a frame on that side.

If no data comes in on that side for longer than the specified number of seconds, an "aborted frame" event is added to the Event Display and the analyzer resumes decoding incoming data. This can occur when capturing interwoven data (DTE and DCE) and one side stops transmitting in the middle of a frame.

The range for this value is from 0 to 999,999 seconds. Setting it to zero disables the timeout feature.

Note: This option is currently disabled.

7.1.1.3 Selecting Start Up Options

To open this window:

1. Choose **System Settings** from the **Options** menu on the Control  window.
2. On the System Settings window, click the **Start Up** button.
3. Choose one of the options to determine if the analyzer starts data capture immediately on starting up or not.

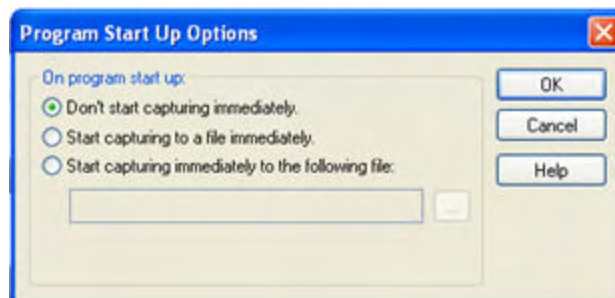



Figure 7.3 - Start Up Options dialog

- **Don't start capturing immediately** - This is the default setting. The analyzer begins monitoring data but does not begin capturing data until clicking the **Start Capture**  icon on the **Control, Event Display** or **Frame Display** windows.
- **Start capturing to a file immediately** - When the analyzer starts up, it immediately opens a capture file and begins data capture to it. This is the equivalent of clicking the **Start Capture**  icon. The file is given a name based on the settings for capturing to a file or series of files in the **System Settings** window.
- **Start capturing immediately to the following file:** - Enter a file name in the box below this option. When the analyzer starts up, it immediately begins data capture to that file. If the file already exists, the data in it is overwritten.

7.1.2 Changing Default File Locations

The analyzer saves user files in specific locations by default. Capture files are placed in the My Capture Files directory and configurations are put in My Configurations. These locations are set at installation.

Follow the steps below to change the default locations.

1. Choose **Directories** from the **Options** menu on the **Control** window to open the **File Locations** window.

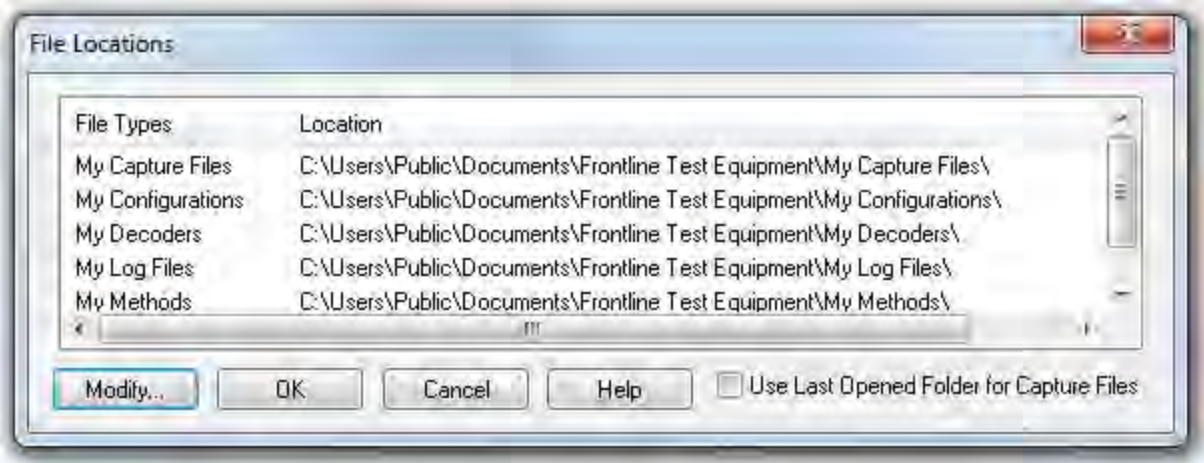

Figure 7.4 - File Locations dialog

2. Select the default location you wish to change.
3. Click **Modify**.
4. Browse to a new location.

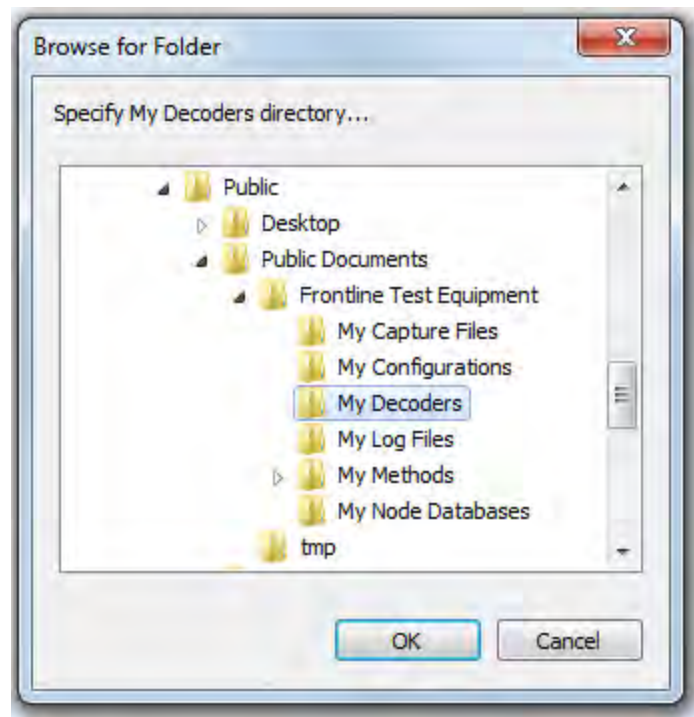

Figure 7.5 - File Locations Browse dialog

5. Click **OK**.
6. Click **OK** when finished.

If a user sets the My Decoders directory such that it is up-directory from an installation path, multiple instances of a personality entry may be detected, which causes a failure when trying to launch Frontline. For example, if an Frontline product is installed at C:\Users\Public\Public Documents\Frontline Test Equipment\My Decoders\ then "My Decoders" cannot be set to any of the following:

- C:\ My Decoders\
- C:\Users\ My Decoders\
- C:\Users\Public\My Decoders\
- C:\Users\Public\Public Documents\My Decoders\
- or to any directory that already exists in the path C:\Users\Public\Public Documents\Frontline Test Equipment\My Decoders\

Default Capture File Folder Checkbox

If the **Use Last Opened Folder for Capture Files** checkbox is checked, then the system automatically changes the default location for saving capture files each time you open a file from or save a file to a new location. For example, let's say the default location for saving capture files is Drive A > Folder A. Now you select the **Use Last Opened Folder for Capture Files** checkbox. The next time, however, you open a capture file from a different location, Folder B > Removable Flash Drive for example. Now when you save the capture file, it will be saved to Folder B > Removable Flash Drive. Also, all subsequent files will be saved to that location. This remains true until you open a file from or save a file to a different location.

There is one caveat to this scenario, however. Let's say you have selected **Use Last Opened Folder for Capture Files** and opened a file from a location other than the default directory. All subsequent capture files will be saved to that location. Suppose, however, the next time you want to save a capture file, the new file location is not available because the directory structure has changed: a folder has been moved, a drive has been reassigned, a flash drive has been disconnected, etc. In the case of a "lost" directory structure, subsequent capture files will be saved to the default location. **ComProbe software will always try to save a file to the folder where the last file was opened from or saved to, if Use Last Opened Folder for Capture Files is checked.** If, however, the location is not accessible, files are saved to the default directory that is set at installation.

If the checkbox is unchecked, then the system always defaults to the directory listed in the File Locations dialog.

7.1.3 Side Names

The **Side Names** dialog is used to change the names of objects and events that appear in various displays. **The Side Names** dialog will change depending on the sniffing technology in use at the time the software was loaded.

Changes to the Names are used throughout the program.



Figure 7.6 - Example: Side Names Where "Slave" and "Master" are current

1. To open the Side Names dialog, choose **Side Names...** from the **Options** menu on the **Control** window.
2. To change a name, click on the name given in the **Current Names** column, and then click again to modify the name (a slow double-click).
3. Select **OK** to initiate the changes. The changes that have been made will not fully take effect for any views already open. Closing and reopening the views will cause the name change to take effect.
4. To restore the default values, click the **Set Defaults** button.

7.1.4 Timestamping

Timestamping is the process of precise recording in time of packet arrival. Timestamps is an optional parameter in the Frame Display and Event Display that can assist in troubleshooting a network link.

7.1.4.1 Timestamping Options

The Timestamping Options window allows you to enable or disable timestamping, and change the resolution of the timestamps for both capture and display purposes.

To open this window:

Choose **Set Timestamp Format...** from the **Options** menu on the Frame Display and Event Display window or click on the **Timestamping Option**  icon in the **Event Display** toolbar. The Timestamping Options window will open.

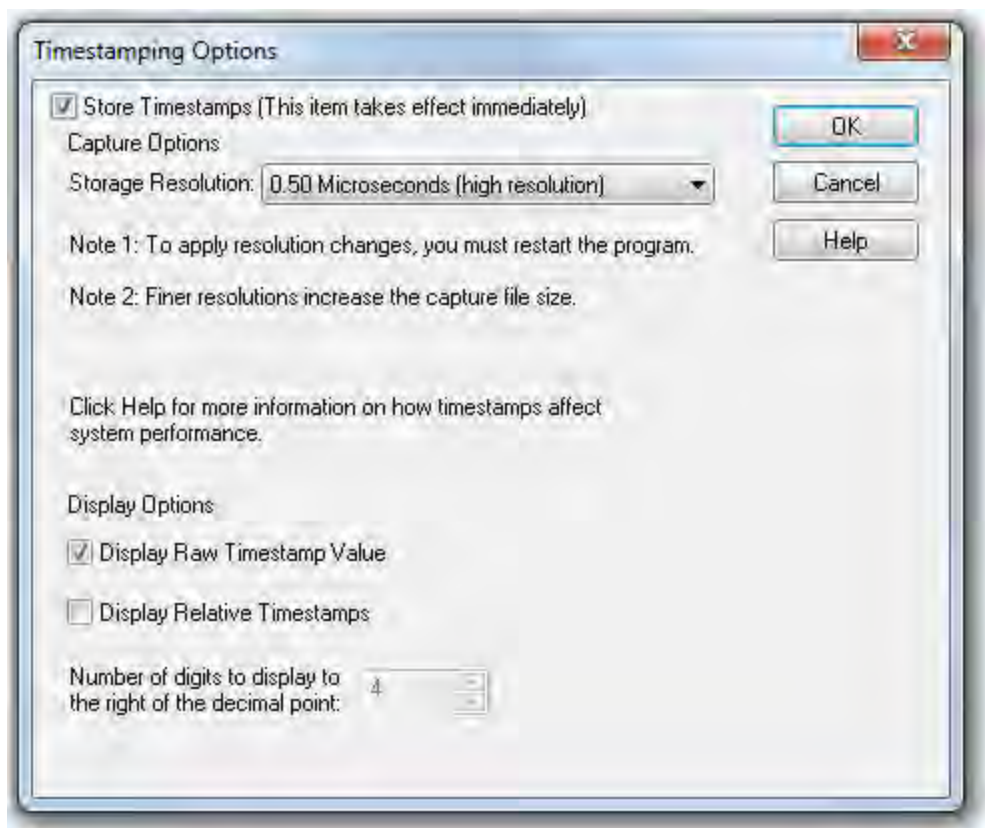

Figure 7.7 - Timestamping Options dialog

Enabling/Disabling Timestamp

To enable timestamping click to make a check appear in the check box **Store Timestamps (This time takes effect immediately)**. Removing the check will disable timestamping.

Changing the Timestamp Resolution

This option affects the resolution of the timestamp stored in the capture file. The default timestamp is 10 milliseconds. This value is determined by the operating system and is the smallest "normal" resolutions possible.

Note: The raw timestamp value is the number of 100-nanosecond intervals since the beginning of January 1, 1601. This is standard Windows time.

It is also possible to use "high resolution" timestamping. High resolution timestamp values are marked by an asterisk as high resolution in the drop down list. To change timestamping resolutions:

1. Go to the **Capture Options** section of the window.
2. Change the resolution listed in the

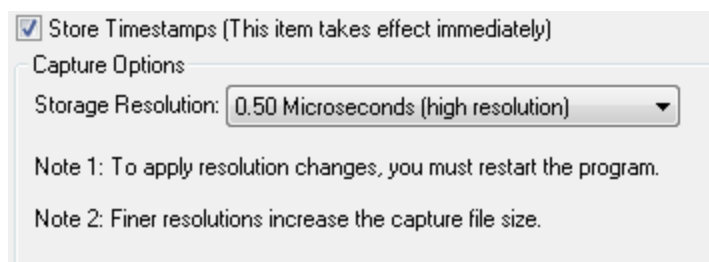

Storage Resolution box.

Note: If you change the resolution, you need to exit the analyzer and restart in order for the change to take effect.

Performance Issues with High Resolution Timestamp



There are two things to be aware of when using high resolution timestamps. The first is that high resolution timestamps take up more space in the capture file because more bits are required to store the timestamp. Also, more timestamps need to be stored than at normal resolutions. The second issue is that using high resolution timestamping may affect performance on slower machines

For example, if 10 bytes of data are captured in 10 milliseconds at a rate of 1 byte per millisecond, and the timestamp resolution is 10 milliseconds, then only one timestamp needs to be stored for the 10 bytes of data. If the resolution is 1 millisecond, then 10 timestamps need to be stored, one for each byte of data. If you have two capture files, both of the same size, but one was captured using normal resolution timestamping and the other using high resolution, the normal resolution file has more data events in it, because less room is used to store timestamps.

You can increase the size of your capture file in the [System Settings](#).

Switching Between Relative and Absolute Time

With Timestamping you can choose to employ Relative Time or Absolute time.



1. Choose **System Settings** from the **Options** menu on the **Control** window, and click the **Timestamping Options** button, or click the **Timestamping Options** icon  from the **Event Display**  window.
2. Go to the **Display Options** section at the bottom of the window and find the **Display Relative Timestamps** checkbox.
3. Check the box to switch the display to relative timestamps. Remove the check to return to absolute timestamps.

Note: The options in this section affect only how the timestamps are displayed on the screen, not how the timestamps are recorded in the capture file.

- **Display Raw Timestamp Value** shows the timestamp as the total time in hundred nanoseconds from a specific point in time.
- **Display Relative Timestamps** shows the timestamp as the amount of time that has passed since the first byte was captured. It works just like a stop watch in that the timestamp for the first byte is 0:00:00.0000 and all subsequent timestamps increment from there. The timestamp is recorded as the actual time, so you can flip back and forth between relative and actual time as needed.
- Selecting both values displays the total time in nanoseconds from the start of the capture as opposed to a specific point in time.
- Selecting neither value displays the actual chronological time.

When you select **Display Relative Timestamp** you can set the number of digits to display using the up or down arrows on the numeric list.

Displaying Fractions of a Second

1. Choose **System Settings** from the **Options** menu on the **Control**  window, and click the **Timestamping Options** button, or click the **Timestamping Options** icon  from the **Event Display**  window.
2. Go to the **Display Options** section at the bottom of the window, and find the **Number of Digits to Display** box.
3. Click on the arrows to change the number. You can display between 0 and 6 digits to the right of the decimal point.

7.2 Technical Information

7.2.1 Performance Notes

As a software-based product, the speed of your computer's processor affects the analyzer's performance. Buffer overflow errors are an indicator that the analyzer is unable to keep up with the data. The information below describes what happens to the data as it arrives, what the error means, and how various aspects of the analyzer affect performance. Also included are suggestions on how to improve performance.

The analyzer's driver takes data from the driver and counts each byte as they are put into the driver's buffer. The analyzer's driver tells the user interface that data is ready to be processed. The analyzer takes the data from the driver's buffer and puts the data into the capture buffer.

Driver Buffer Overflows occur when the user interface does not retrieve frames from the driver quickly enough. Buffer overflows are indicated in the **Event Display** window by a plus sign within a circle. Clicking on the buffer overflow symbol displays how many frames have been lost.

There are several things that you can do to try and solve this problem.

- Use capture filters to filter out data you don't need to see. Capture filters reduce the amount of data processed by the analyzer. (Ethernet Only)
- Close all other programs that are doing work while the analyzer is running. Refrain from doing searches in the **Event Display** window or other processor intensive activities while the analyzer is capturing data.
- Timestamping takes up processor time, primarily not in timestamping the data, but in writing the timestamp to the file. Try turning off timestamping from the [Timestamping Options](#) window.
- For **Driver Buffer Overflows**, change the size of the driver buffer. This value is changed from the **Advanced System Settings**. Go to the **Control** window and choose **System Settings** from the **Options** menu. Click on the **Advanced** button. Find the value **Driver Receive Buffer Size in Operating System Pages**. Take the number listed there and double it.
- The analyzer's number one priority is capturing data; updating windows is secondary. However, updating windows still takes a certain amount of processor time, and may cause the analyzer to lose data while the window is being updated. Some windows require more processing time than others because the information being displayed in them is constantly changing. Refrain from displaying data live in the **Event Display** and

Frame Display windows. The analyzer can capture data with no windows other than the **Control** window open.

- If you are still experiencing buffer overflows after trying all of the above options, then you need to use a faster PC.

7.2.2 Progress Bars

The analyzer uses progress bars to indicate the progress of a number of different processes. Some progress bars (such as the filtering progress bar) remain visible, while others are hidden.

The title on the progress bar indicates the process underway.

7.2.3 Event Numbering

This section provides information about how events are numbered when they are first captured and how this affects the display windows in the analyzer. The information in this section applies to frame numbering as well.

When the analyzer captures an event, it gives the event a number. If the event is a data byte event, it receives a byte number in addition to an event number. There are usually more events than bytes, with the result is that a byte might be listed as Event 10 of 16 when viewing all events, and Byte 8 of 11 when viewing only the data bytes.

The numbers assigned to events that are wrapped out of the buffer are not reassigned. In other words, when event number 1 is wrapped out of the buffer, event number 2 is not renumbered to event 1. This means that the first event in the buffer may be listed as event 11520 of 16334, because events 1-11519 have been wrapped out of the buffer. Since row numbers refer to the event numbers, they work the same way. In the above example, the first row would be listed as 2d00 (which is hex for 11520.)

The advantage of not renumbering events is that you can save a portion of a capture file, send it to a colleague, and tell your colleague to look at a particular event. Since the events are not renumbered, your colleague's file use the same event numbers that your file does.

7.2.4 Useful Character Tables

7.2.4.1 ASCII Codes

hex	x0	x1	x2	x3	x4	x5	x6	x7	x8	x9	xA	xB	xC	xD	xE	xF
0x	NUL	SOH	STX	ETX	EOT	ENQ	ACK	BEL	BS	HT	LF	VT	FF	CR	SO	SI
1x	DLE	DC1	DC2	DC3	DC4	NAK	SYN	ETB	CAN	EM	SUB	ESC	FS	GS	RS	US
2x	SP	!	"	#	\$	%	&	'	()	*	+	,	-	.	/
3x	0	1	2	3	4	5	6	7	8	9	:	;	<	=	>	?
4x	@	A	B	C	D	E	F	G	H	I	J	K	L	M	N	O
5x	P	Q	R	S	T	U	V	W	X	Y	Z	[\]	^	_
6x	`	a	b	c	d	e	f	g	h	i	j	k	l	m	n	o
7x	p	q	r	s	t	u	v	w	x	y	z	{		}	~	DEL

7.2.4.2 Baudot Codes

DEC	HEX	LETTERS	FIGURES
0	00	BLANK (NUL)	BLANK (NUL)
1	01	E	3
2	02	LF	LF
3	03	A	-
4	04	SP	SP
5	05	S	BEL
6	06	I	8
7	07	U	7
8	08	CR	CR
9	09	D	\$
10	0A	R	4
11	0B	J	'
12	0C	N	,
13	0D	F	!
14	0E	C	:
15	0F	K	(
16	10	T	5
17	11	Z	*
18	12	L)
19	13	W	2
20	14	H	#
21	15	Y	6
22	16	P	0
23	17	Q	1
24	18	O	9
25	19	B	?
26	1A	G	&
27	1B	FIGURES	FIGURES
28	1C	M	.
29	1D	X	/
30	1E	V	;
31	1F	LETTERS	LETTERS

7.2.4.3 EBCDIC Codes

hex	x0	x1	x2	x3	x4	x5	x6	x7	x8	x9	xA	xB	xC	xD	xE	xF
0x	NUL	SOH	STX	ETX	PF	HT	LC	DEL			SMM	VT	FF	CR	SO	SI
1x	DLE	DC1	DC2	TM	RES	NL	BS	IL	CAN	EM	CC	CU1	IFS	IGS	IRS	IUS
2x	DS	SOS	FS		BYP	LF	ETB	ESC			SM	CU2		ENQ	ACK	BEL
3x			SYN		PN	RS	UC	EOT				CU3	DC4	NAK		SUB
4x	SP												.	<	(+
5x	&											\$	*)	:	^
6x	-	/										.	%	_	>	?
7x											:	#	@	'	=	"
8x		a	b	c	d	e	f	g	h	i						
9x		j	k	l	m	n	o	p	q	r						
Ax		~	s	t	u	v	w	x	y	z						
Bx																
Cx	{	A	B	C	D	E	F	G	H	I						
Dx	}	J	K	L	M	N	O	P	Q	R						
Ex	\		S	T	U	V	W	X	Y	Z						
Fx	0	1	2	3	4	5	6	7	8	9						

7.2.4.4 Communication Control Characters

Listed below in alphabetical order are the expanded text meanings for common ANSI communication control characters, and two-character system abbreviation for each one. Some abbreviations have forward slash

characters between the two letters. This is to differentiate the abbreviations for a control character from a hex number. For example, the abbreviation for Form Feed is listed as F/F, to differentiate it from the hex number FF.

Table 7.1 - Communications Control Characters

Abbreviation	Control Character	Text
AK	ACK	Acknowledge
BL	BEL	Bell
BS	BS	Backspace
CN	CAN	Cancel
CR	CR	Carriage Return
D/1-4	DC1-4	Device Control 1-4
D/E	DEL	Delete
DL	DLE	Data Link Escape
EM	EM	End of Medium
EQ	ENQ	Enquiry
ET	EOT	End of Transmission
E/C	ESC	Escape
E/B	ETB	End of Transmission Block
EX	ETX	End of Text
F/F	FF	Form Feed
FS	FS	File Separator
GS	GS	Group Separator
HT	HT	Horizontal Tabulation
LF	LF	Line Feed
NK	NAK	Negative Acknowledge
NU	NUL	Null
RS	RS	Record Separator
SI	SI	Shift In
SO	SO	Shift Out
SH	SOH	Start of Heading
SX	STX	Start of Text
SB	SUB	Substitute
SY	SYN	Synchronous Idle

Table 7.1 - Communications Control Characters(continued)

Abbreviation	Control Character	Text
US	US	Unit Separator
VT	VT	Vertical Tabulation

7.2.5 DecoderScript Overview

The main purpose of this manual is to describe DecoderScript™, the language used in writing decoders. DecoderScript allows you to create new decoders or modify existing decoders to expand the functionality of your ComProbe protocol analyzer. DecoderScript displays protocol data, checks the values of fields, validates checksums, converts and combines field values for convenient presentation. Decoders can also be augmented with custom C++-coded functions, called "methods", to extend data formatting, validation, transformations, and so on.

A decoder defines field-by-field how a protocol message can be taken apart and displayed. The core of each "decoder" is a program that defines how the protocol data is broken up into fields and displayed in the Frame Display window of the analyzer software.

This manual provides instruction on how to create and use custom decoders. When reading the manual for the first time, we encourage you to read the chapters in sequence. The chapters are organized in such a way to introduce you to DecoderScript writing step- by- step.

Screenshots of the ComProbe protocol analyzer have been included in the manual to illustrate what you see on your own screen as you develop decoders. But you should be aware for various reasons, the examples may be slightly different from the ones that you create. The differences could be the result of configuration differences or because you are running a newer version of the program. Do not worry if an icon seems to be missing, a font is different, or even if the entire color scheme appears to have changed. The examples are still valid.

Examples of decoders, methods, and frame recognizers are included in this manual. You can cut and paste from these examples to create your own decoders.

A quick note here: Usually the pasted code appears the same as the original in your editor. Some editors, however, change the appearance of the text when it is pasted (something to do with whether it is ASCII or Unicode text). If you find that the pasted text does not appear the same as the original, you can transfer the code into a simple text editor like Notepad, save it as an ANSI (ASCII) file, then use it in your decoder.

These files are installed in the FTE directory of the system Common Files directory. The readme file in the root directory of the protocol analyzer installation contains a complete list of included files. Most files are located in My Decoders and My Methods.

We will be updating our web site with new and updated utilities, etc, on a regular basis and we urge decoder writers to check there occasionally.

7.2.6 Bluetooth low energy ATT Decoder Handle Mapping

Low energy device attributes contain a 16-bit address called the attribute handle. Each handle is associated with an attribute Universally Unique Identifier (UUID) that is 128-bits long. In the attribute database, the handle is unique while the UUID is not unique.

The ComProbe software detects and stores the relationships (mappings) between handle and UUID during the GATT discovery process. But sometimes, there is no GATT discovery process because

- The discovery has previously taken place and both devices stored the mappings and the discovery will not repeat at every subsequent connection.
- The developer owns both devices in the conversation and chose to ignore discovery because the mappings are known.
- The devices are in development and the code to perform the mappings has not been written yet.

The solution to this problem is to

1. define the mappings in a file and
2. then pre-loading the mapping using the ComProbe software.

Creating handle-UUID mapping file

Create a file named "ATT_Handle_UUID_Preload.ini" in the root directory of "C:\Users\Public\Public Documents\Frontline Test Equipment\My Decoders\", but the file can be located anywhere.

Assume that you want to create a GATT service starting at handle 1.

Create a section in the ini file called

```
[Service Base Handles]
A=1
```

"A" will be your first service. Make the base handle equal to the handle of your service. You can use all upper and lower case letters so you can have up to 52 service handles.

Next add the following section.

```
[Advertiser Handles]
; Generic Access Profile (GAP)
A0 = 1800
A1 = 2803
A2 = 2a00
A3 = 2803
A4 = 2a01
A5 = 2803
A6 = 2a04
```

A few things of note:

- In the code above, lines begging with a semi-colon are comments.
- If you want to change the base handle of the GAP service, change the "1" to some other number.
- If you want to comment out the entire service, comment out the base handle. If no "A" is defined, the software will ignore "A1", "A2" and so on.

Contacting Technical Support

Technical support is available in several ways. The online help system provides answers to many user related questions. Frontline's website has documentation on common problems, as well as software upgrades and utilities to use with our products.

On the Web: <http://fte.com/support/supportrequest.aspx>

Email: tech_support@fte.com

If you need to talk to a technical support representative about your Frontline 802.11 product, support is available between 9 am and 5 pm, U.S. Eastern Time zone, and between 9 am and 5 pm, Pacific Time zone, on Monday through Friday. Technical support is not available on U.S. national holidays.

Phone: +1 (434) 984-4500

Fax: +1 (434) 984-4505

Instructional Videos

Teledyne LeCroy provides a series of videos to assist the user and may answer your questions. These videos can be accessed at fte.com/support/videos.aspx. On this web page use the **Video Filters** sidebar to select instructional videos for your product.

Appendices

Appendix A: Application Notes	200
-------------------------------------	-----

Appendix A: Application Notes

A.1 ComProbe Automation Server: Why use it?	202
----------------------------------------------------------	------------

A.1 ComProbe Automation Server: Why use it?

Frontline provides a full line of wireless sniffing devices for developers that include ComProbe BPA 600 for Bluetooth® Classic, low energy, and coexistence; ComProbe 802.11 for Wi-Fi and *Bluetooth* coexistence. Normal ComProbe protocol analyzer use is through a GUI on a personal computer. In this operation mode the user has direct control of the setup and data capture through the keyboard and mouse. User specific ComProbe analyzer configuration and capture decisions may come from user prescribed test documents or applied ad hoc or on-the-fly.

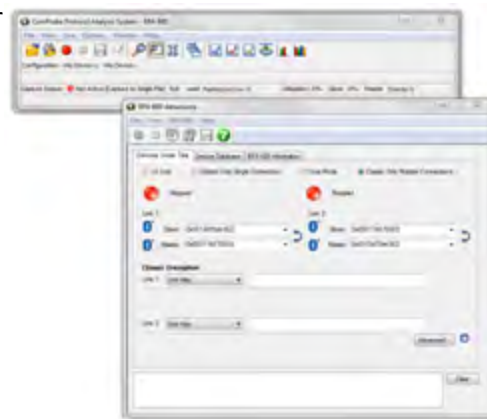

Figure 1 - ComProbe GUI

The ComProbe software GUI is sufficient for many development projects. But situations may arise where a more automated process is desirable. For example, if a company wants to ensure exact test processes, automating those processes is one answer. When testing multiple devices long test runs can occur, and automating can free up personnel to perform additional tasks. This is a list of possible situations when automation would improve testing and developments operations and save money.

- Automate long test runs – free up personnel for other tasking or run overnight.
- Automatic bookmarking capture data for specific events – helps developers focus on specific test results.
- Automatic adherence to test procedures – ensures test repeatability and eliminates human error.
- Automatic exporting captured data – extracting specific data for post testing analysis outside of the ComProbe software, e.g. export to CSV.
- Automate other Windows – based applications while capturing data – for example, controlling other testing equipment related to the test.
- Automate regression testing.

The larger your task size the more benefit realized in cost avoidance and efficient resource usage through automation of the Frontline ComProbe protocol analyzers. The extra effort to program the test automation is minimal compared to the time saved to manually test.

Frontline's Automation Server provides the means to programmatically control ComProbe software and hardware in a client-server configuration. The Automation Server is provided when you purchase your ComProbe analyzer, and is stored in the Frontline ComProbe Protocol Analysis System directory. The ComProbe Automation Server Protocol Programmers Guide is located in this same directory. The process for automating your data capture is accomplished in three steps.

1. Connect the ComProbe hardware to a computer running ComProbe software and the Automation Server.
2. Launch the Automation Server program. The program will listen to the commands from the Automation Client program and according control the ComProbe software.
3. Write your Automation Client program (use the template provided with the installation package) and run it.

As long as there is no change in the programmed capture process, step 3 can be repeated reliably and without deviation. Should the test plan change, the program written in step 1 can serve as a template to minimize development time and to provide quality control tracability.

A.1.1 Automation Server Topology

The Automation Server executes the commands issued by a user-created Automation client script. The client script can run either on the local PC or on a remote over a TCP/IP connection. The Automation Client program can be written in any language and uses the syntax defined in the ComProbe Automation Server Protocol Programmers Guide. The client will bypass the local Microsoft Windows interface and interacts directly with ComProbe software. One or more instances of the ComProbe software must be running along with one instance of the Automation Server.

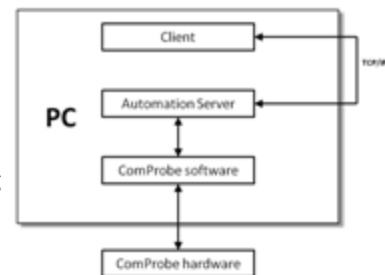

Figure 2 - Automation Server on a Single PC

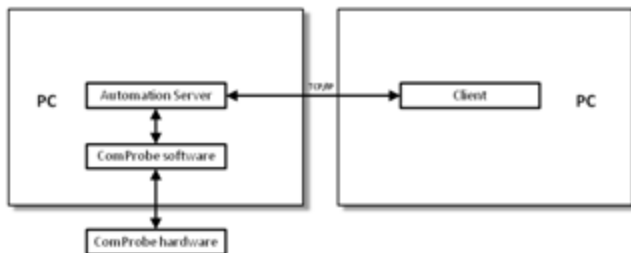

Figure 3 - Automation Server Using Two PCs

A.1.2 Writing Automation Script

Automation scripting is done by persons with knowledge of TCP socket communications. The process automation is achieved by writing a client application which talks over a TCP network socket connection with the ComProbe Automation Server.

Delivered in your ComProbe installation package is a sample script SampleClient.tcl. This script is located in your installation directory. This is typically located at C:\Program Files (x86)\Frontline Test System II\Frontline ComProbe Protocol Analysis System [your version]\Development Tools\. On 32-bit Windows or Windows XP the root installation folder is "C:\Program Files\".

The sample script is written in TCL (Tool Command Language). TCL is an open-source, cross-platform programming language. More information is available at www.tcl.tk. The script can be translated to any general purpose programming language such as C# as long as you retain the program structure.

The sample script is divided into the following sections identified by comments "#".

```
#####
# Procedures
#####
```

1. Procedures
2. Command Wrappers
3. FTE_Base namespace vars
4. Start of Sample Script

Do not change any script in Procedures and Command Wrappers.

FTE_Base namespace vars Modifications

In the "FTE_Base namespace vars" section you will need to identify the connections for the host and the port. Near the top of this section locate the following code at or near line number 747 - 748.

```
set Connections(Host) 0.0.0.0;
set Connections(Port) 22901;
```

For the Host, change 0.0.0.0 to the IP address of the computer running Automation Server. For example 192.168.10.94.

For the Port number, the default is set to 22901, which is not a common TCP port. It is unlikely that another application is using this port, so you can leave the Port set to default 22901.

Note: Before launching the Automation Server, the IP address and IP port—the same as the script Host and Port values—must be modified in the XML configuration file *FTSAutoServer.exe.config*. This file is located in C:\Program Files\Frontline Test System II\Frontline ComProbe Protocol Analysis System [your version]\Executable\Core\ directory. The code to modify is <add key="IPAddr" value="0.0.0.0"/> and <add key="Port" value="22901"/>

Start of Sample Script Modifications

This section is the main part of the program and several lines in the template need to be changed to support your unique data capture environment. First at or around line 792 we need to input the Host IP address again. Locate the following code and enter your Host IP address. FTEBaselnit is a procedure that sets up the TCP connection.

```
FTEBaselnit 192.168.0.90
```

At or around line 803 change "13.1.830.1052" in the following code to the version of your ComProbe software. The version number can be found listed with your Frontline installation directory at C:\Program Files (x86)\Frontline Test System II\ CPASVersion is a variable used in the program to locate your installed version of the ComProbe software.

```
set CPASVersion "C:\\Program Files\\Frontline Test System II\\Frontline ComProbe Protocol Analysis System 13.1.830.1052\\Executables\\Core"
```

Lastly, you need to identify the "personality" of the ComProbe hardware. On or about line 823 you will change the following code to replace the text within the quotes with the personality key that matches your sniffing hardware

configuration. Within the sample script are a few examples of commonly used personalities or "profiles". The Programmers Guide provides a complete list of personalities.

```
set Profile "BPA600_Coex"
```

This code is the personality for using a ComProbe BPA 600 for Classic Bluetooth and a ComProbe 802.11 for Wi-Fi with the software operating in Coexistence View. If you wanted to use just the ComProbe BPA 600 for capturing Classic Bluetooth and Bluetooth low energy then you would change the value in quotes to "BPA600".

Having made these changes to the sample script template you are ready to capture data using your client-server configuration, TCP connection, and capture hardware. At this point you should save the sample script as your own template. As long as you maintain this test setup you will not need to change these settings making your unique template reusable. However you may want to build a library of templates to cover a variety of automation configurations. Once your unique template is coded you will find that development time for variations to the template is insignificant.

In the next section we will step through the remainder of the sample script program to show how the Automation Server converts the sniffing process to a largely self-acting process.

A.1.3 Running Automation Server Script

In this section we will make a comparison between the main program code and the manual operation at the GUI in a sniffing and capture session. This approach will show that the Automation Server will duplicate the manual processes but automation offers reliable repetition of those manual processes and will save time in development and regression testing.

Note: Note that this is sample script and that you will have to change the code in the main program to suit your specific sniffing and capture needs. The command set is outlined in the Programmers Guide in Chapter 3.

On or about line 824 of the sample script you will see the following code. StartFTS tells the Automation Server to launch the ComProbe software by opening your version of Frontline ComProbe Protocol Analysis System and to use a specific personality.

```
StartFTS [format "%s;%s" $CPASVersion $Profile]
```

In the code above from the sample script \$CPASVersion was defined at line 803, and the \$Profile was set at line 823 to use ComProbe BPA 600 and ComProbe 802.11 in coexistence. This is equivalent to 1) double clicking on the Frontline desktop folder and starting the software and 2) selecting a capture method.

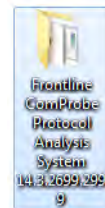

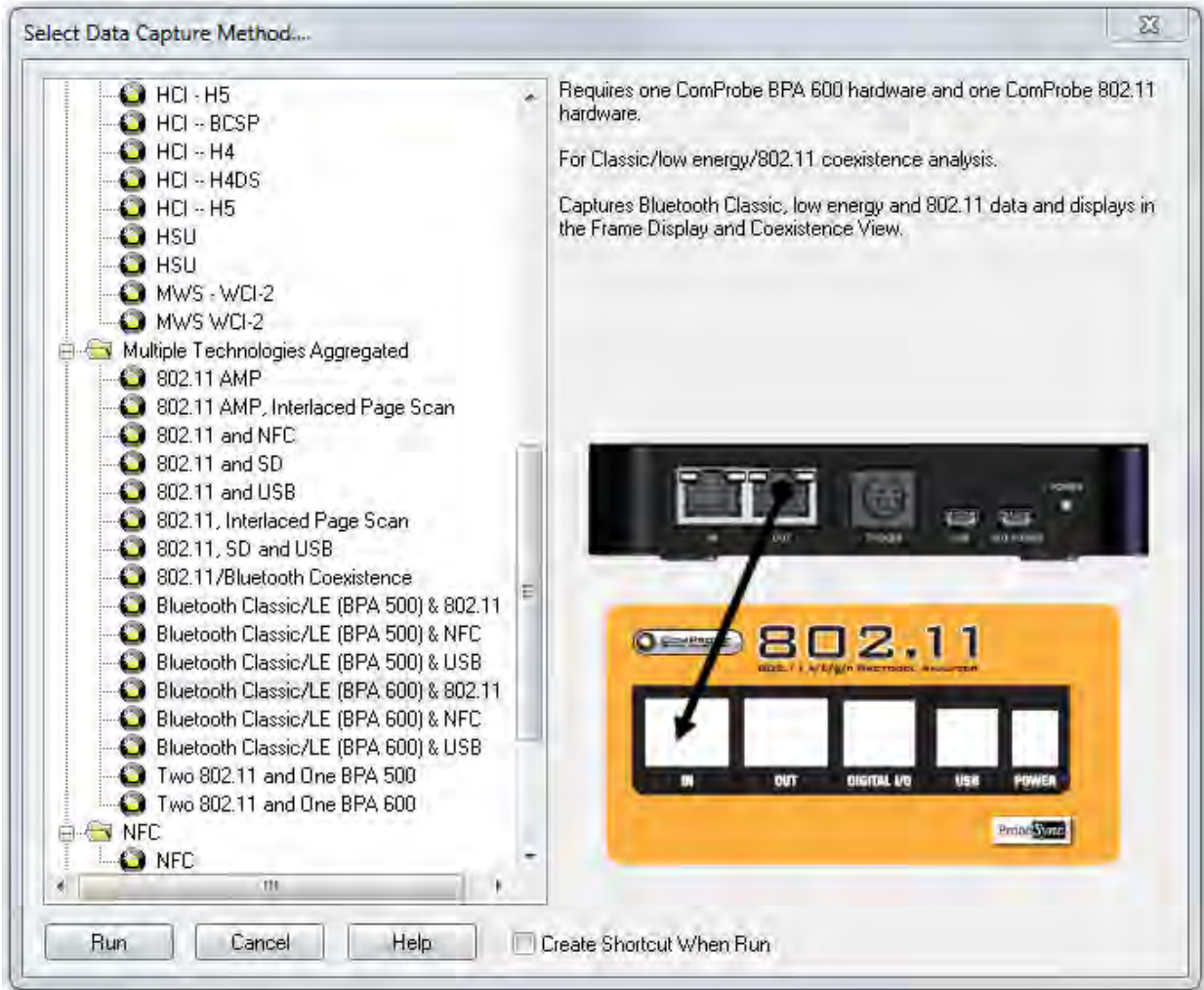

Figure 4 - \$Profile = BPA600_Coex", BPA600 and 802.11 in Coexistence

Moving to line 831 in the sample script we see a configuration setting command for the ComProbe BPA 600. The only parameters shown in this code are the address of the Master and Slave devices. If other parameters are omitted from the code the default values are selected. This line of code is equivalent to setting the BPA 600 datasource for Classic Bluetooth.

```
ConfigSettings [format "IOParameters;BPA600;Master=0x00025b01cb8b;Slave=0x00025b01cbe1"]
```

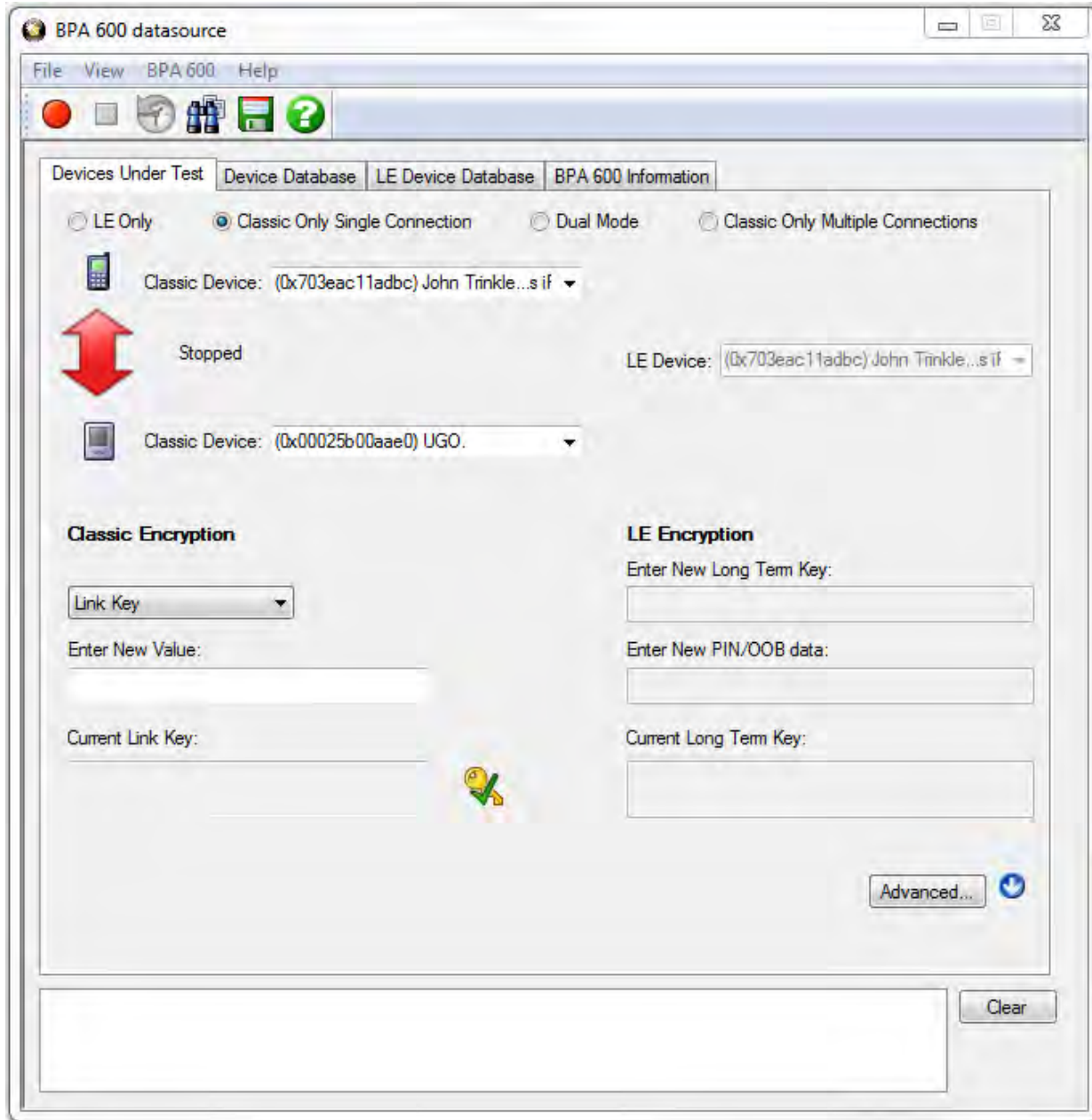



Figure 5 - ConfigSettings equivalent: ComProbe BPA 600 Configuration Settings Dialog

Similar ConfigSettings code will appear in the sample script for the ComProbe 802.11.

At line 853 the StartSniffing command appears. This is equivalent to clicking the **Start Sniffing** button  on the **BPA 600 datasource** toolbar. Start Sniffing will start synchronization of the BPA 600 with the *Bluetooth* Devices. Once synchronization is achieved the arrow between the Classic devices will turn green with the arrow head point to the master device.

StartSniffing

Note: StartSniffing is unique to *Bluetooth* ComProbe devices, and it will automatically execute the Automation Server StartCapture command once synchronized. For non-*Bluetooth* devices use the StartCapture command that is equivalent to the Start Capture button  in the Control window.

At line 874 the following code will halt the capture after 10 seconds. This bit of code illustrates the control that you can have over the capture process.

after 10000

At line 879 we have another *Bluetooth*-unique command that stops the sniffing and is equivalent to clicking the Stop Sniffing button  on the BPA 600 datasource.

StopSniffing

Here is one of those *Bluetooth*-unique situations. At line 889 the Stop Capture command is issued. Unlike the Start Sniffing command, the Stop Sniffing command does not automatically execute the Stop Capture command so it must be in the program if using ComProbe *Bluetooth* hardware. Stop Capture will stop the capture of data. This command is equivalent to clicking on the **Stop Capture** button  on the **Control** window.

StopCapture

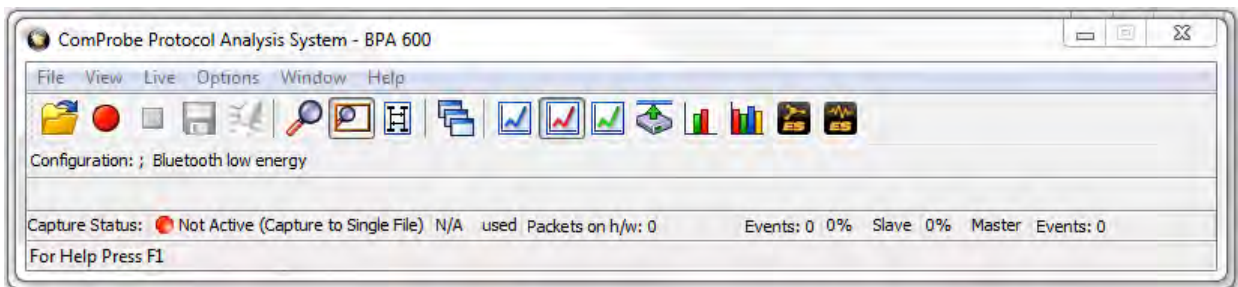

Figure 6 - BPA 600 **Control** window; **Stop Capture** is to the right of the red button.

At the end of the program you will want to stop the ComProbe software, so at line 900 we have the following code.

StopFTS

Finally good programming housekeeping dictates that you should clear all connections. The following procedure will disconnect the client-server and breakdown the TCP connection.

FTEBaseCleanup

This section has hit only the highlights of the sample script, but it has illustrated the connection between Automation and the manual sniffing and capture of data. Your programs may be more detailed and will certainly use many more commands. Refer to the ComProbe Automation Server Protocol Programmers Guide for more information on the command set.

A.1.4 Saving Automation Captured Data

The Automation Server sample script gives you a building block for building your ComProbe hardware and software sniffing and data capture process. Of course the primary purpose for using ComProbe products may be

to analyze the captured data to solve design and development issues, and to test your products. The sample script does not provide sample code for the saving and exporting of the captured data.

The Save Capture command is equivalent to clicking on the ComProbe software **Control** window **File** menu **Save** selection. The **Save** selection opens a Save as dialog where you would enter the location and file name for your capture data—a .cfa file. The Save Capture command contains parameters that perform the same operation only automatically.

Save Capture;c:\Users\Public\Public documents\Frontline Test Equipment\My Capture Files\mycap.cfa

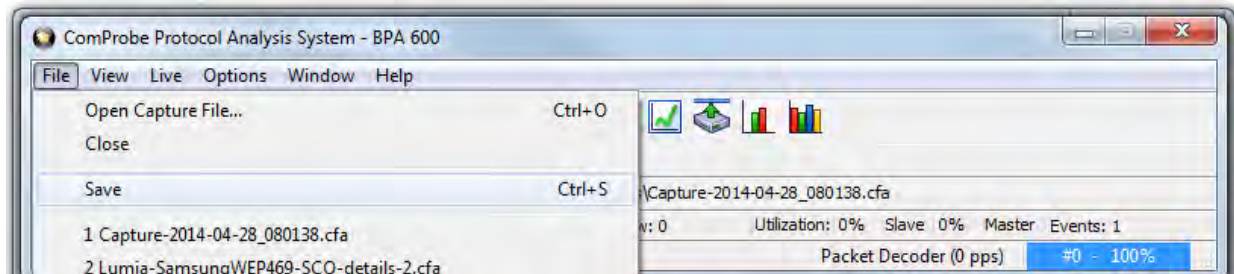

Figure 7 - ComProbe Software **File Save**

Save Capture command will save the entire capture file, which can be reloaded into the ComProbe software for later analysis. To reload the capture file you use the Automation Server Open Capture File command that has similar parameters to the Save Capture command.

Open Capture File;c:\Users\Public\Public documents\Frontline Test Equipment\My Capture Files\mycap.cfa

While the Save Capture automatically archives everything that happened during the capture session you may want to write a script that focuses on specific protocols. To do that you use the Automation Server Export command that tells ComProbe software to invoke the **Frame Display** and then automatically selects the **File Export** menu option. In the example code below the data is exported to the identified path/file, is waiting for the frame to complete, and is selecting the 802.11 MAC protocol tab..

Export;c:\Users\Public\Public documents\Frontline Test Equipment\My Capture Files\mycap.csv;Mode=0;Tab=802.11:802.11 MAC

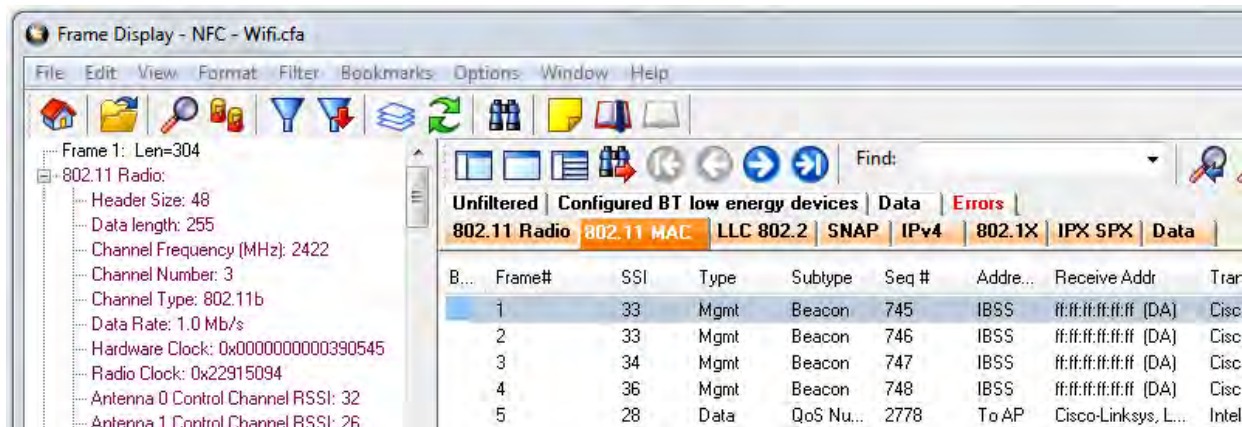

Figure 8 - Export Command equivalent: Frame Display 802.11 MAC tab selected

Refer to the ComProbe Automation Server Protocol Programmers Guide for detail of the Export command Mode and Tab parameters.

Export provides you with the ability to automatically save specific protocol data that may be the focus of your analysis. The exported file is saved as a comma separate value (.csv) file type. This file may be opened for later analysis in any application that supports .csv format such as Microsoft Excel or Access.

A.1.5 Keeping Track of Events

Automation Server Add Bookmark command will automatically add a book mark to the last frame currently in the capture buffer.

Consider this scenario. You have set up your automation script but you want to keep track of the specific events, for example when you start streaming music from your smart phone to a *Bluetooth* speaker. The

```
Add Bookmark;String=StartMusicStream
```

In this scenario the Add Bookmark command may be used with TCL conditional statements to detect and guide the event actions. The string parameter will be the name on the bookmark for your saved or exported data capture. When analyzing the automated capture session at a later date you can use the bookmark to localize your analysis to the event.

A.1.6 Automation Can Save Time and Money

In a carefully considered design, development, or testing environment automation of wireless sniffing and data capture can save time and money. The Frontline Automation Server gives you the means to save time by ensuring process are reliably reproduced. This is especially true for situations when you want to run the identical tests on several products or versions of a product. Being able to compare captured data across design versions is enhanced when you can run exactly the same process.

Up-front automation script development time is a consideration when setting up an automated sniffing process. The ComProbe Automation Server Protocol Programmers Guide is delivered with your installation package, and the latest version is always available for download on FTE.com/support/documents in ComProbe Automation. Should you need additional assistance with the Automation Server, contact Frontline's technical support team.

Copyright 2017 Frontline Test Equipment, Inc.

Author: John Trinkle

Publish Date: 8 May 2014

The Bluetooth SIG, Inc owns the *Bluetooth* word mark and logos, and use of such marks is under license.

Index

8

802.11 I/O Settings 19-20

A

Aborted Frame 184
 About Display Filters 81
 Absolute Time 190
 Add a New or Save an Existing Template 39
 Adding a New Predefined Stack 59
 Adding Comments To A Capture File 171
 Advanced System Options 183
 Apply Capture Filters 83
 Apply Display Filters 81-86
 ASCII 136
 character set 192
 viewing data in 136
 ASCII Codes 192
 ASCII Pane 78
 Auto-Sizing Column Widths 75
 Automatically Request Missing Decoding Information 62
 Automatically Restart 181
 Automatically Restart Capturing After 'Clear Capture Buffer' 181
 Automatically Save Imported Capture Files 181
 Autotraversal 59, 61

B

Bar Charts 146
 Baudot 136, 180
 Baudot Codes 192
 Begin Sync Character Strip 138
 Binary 135, 153

Binary Pane 78
 BL 194
 Bookmarks 166-167
 Boolean 84, 89
 Broken Frame 137
 BS 194
 Buffer 170, 181
 Buffer Overflow 181
 Buffer Tabs 145
 Buffer/File Options 181
 Byte 79, 133, 135, 192
 Searching 156
 byte export 72

C

Calculating Data Rates and Delta Times 134
 Capture Buffer 170, 181, 183
 Capture Buffer Size 181
 Capture File 49, 170-173, 181, 183
 auto-save imported files 181
 capture to a series of files 181
 capture to one file 181
 changing default location of 185
 changing max size of 181, 183
 framing captured data 60
 importing 173
 loading 172
 reframing 60
 removing framing markers 60
 saving 170-171
 starting capture to file 49



-
- Capturing 49
 - Data to Disk 49
 - CFA file 171-172
 - Changing Default File Locations 185
 - Character 153, 193
 - Character Pane 78
 - Character Set 136, 192-193
 - Characters Per Second Table 146
 - Choosing a Data Capture Method 7
 - Clear Capture Buffer 181
 - CN 194
 - Coexistence View 97
 - le Devices Radio Buttons 118
 - Legend 119
 - Set Button 117
 - Throughput Graph 110
 - Discontinuities 111
 - Dots 113
 - Swap Button 112
 - Viewport 112
 - Zoom Cursor 116
 - Zoomed 114
 - Freeze Y 115
 - Unfreeze Y 115
 - Y Scales Frozen 115
 - Throughput Indicators 107
 - Throughput Radio Buttons 118
 - Timeline Radio Buttons 118
 - Timelines 119
 - discontinuities 127
 - high-speed 128
 - packet 120
 - two timelines 124
 - Toolbar 105
 - Tooltip 111
 - relocate 111, 122
 - Color of Data Bytes 79
 - Colors 80
 - Comma Separated File 177
 - Compound Display Filters 84
 - Confirm CFA Changes 172
 - Context For Decoding 62
 - Control Characters 193
 - Control Signals 137, 187
 - Control Window 17, 181
 - Configuration Information 12
 - Conversation Filters 85
 - Copying Statistics 146
 - CPAS Control Window Toolbar 11
 - CR 194
 - CRC 133
 - CSV Files 177
 - Custom Protocol Stack 57, 59
 - Custom Stack 58-59
 - Customizing Fields in the Summary Pane 75
- D**
- D/1 194
 - D/2 193
 - D/3 193
 - D/4 193
 - D/E 194
-



Data 134, 169-170

- Capturing 49

Data Byte Color Denotation 79

Data Errors 162

Data Extraction 139

Data Rates 134

Decimal 135

Decode Pane 77

decoder 195

Decoder Parameters 36

DecoderScript 195

Decodes 36, 57, 62, 68, 77, 150

Default File Locations 185

Delete a Template 40

Deleting Display Filters 86

Delta Times 134

Direction 86

Directories 185

Disabling 181

Display Filters 81, 86-89

Display Options 191

DL 194

Dots 76

Duplicate View 71, 131, 133

E

E/B 194

E/C 194

Easy Protocol Filtering 96

EBCDIC 136

- EBCDIC Codes 193

EIR 56

EM 193

EQ 194

Errors 80, 97, 162, 187

ET 193

Event Display 70, 131, 177

- Event Display Export 177
- Event Display Toolbar 132
- Event Numbering 192
- Event Pane 79
- Event Symbols 137

EX 193

Exclude 83

Exclude Radio Buttons 83

Expand All/Collapse All 77

Expand Decode Pane 71

Export

- Export Baudot 180
- Export Events 178
- Export Filter Out 180

Extended Inquiry Response 56

F

F/F 193

FCSs 133

Field Width 75

File 169-172, 181

File Locations 185

File Series 181

File Types Supported 172

Filtering 95

Filters 81-89, 96

Find 150, 153-154, 156-157, 162



Find - Bookmarks 164
 Find Introduction 149
 Font Size 139
 Frame Display 62, 64, 67-68, 70-71, 75-80
 Frame Display - Change Text Highlight Color 79
 Frame Display - Find 68
 Frame Display Status Bar 67
 Frame Display Toolbar 64
 Frame Display Window 62
 Frame Recognizer Change 138
 Frame Symbols 76
 Frame Information on the Control Window 13
 Freeze 134
 FS 194

G

Go To 156
 Graphs 147
 Green Dots in Summary Pane 76
 GS 193

H

Hardware Settings Overview 802.11 19, 33
 Hex 135
 Hexadecimal 78
 Hiding Display Filters 86
 Hiding Protocol Layers 68
 High Resolution Timestamping 190
 HT 194

I

I/O Settings 43
 I/O Settings Change 138
 Icons in Data on Event Display 137

Importable File Types 173
 Importing Capture Files 172
 INCLUDE 83
 Include/Exclude 83

L

Layer Colors 80
 LF 194
 Live Update 134
 Logical Byte Display 68
 Logical Bytes 68
 Long Break 138
 Low Power 138

M

Main Window 10
 Master 43
 Minimizing 17
 Mixed Channel/Sides 136
 Mixed Sides Mode 136
 Modem Lead Names 187
 Modify Display Filters 88
 Multiple Event Displays 133
 Multiple Frame Displays 71

N

NK 194
 Node Filters 85
 Nonprintables 180
 Notes 171
 NU 193
 Number Set 135
 Numbers 192



O

Octal 135

Open 133

Open Capture File 172

Options 181, 183-184, 188

Other Term

Subterm 16

Overriding Frame Information 62

Overrun Errors 163

P

Panes 71

Pattern 152

Pause 49

Performance Notes 191

Physical Errors 80

Pie Charts 146

Port Assignment 42

Printing 147, 176

Printing from the Frame Display 173

Progress Bars 192

Protocol

Protocol Layer Colors 80

Protocol Layer Filtering 95

Protocol Stack 58-59, 61

Q

Quick Filtering 95, 97

R

Radix 78, 135

Red Frame Numbers 80

Reframe 60

Reframing 60

Relative Time 154, 190

Remove

Bookmarks 166-167

Columns 76

Custom Stack 58

Filters 86

Framing Markers 60

Reset Panes 71

Resetable Tab 145

Resolution 189

Resumed 137

Revealing Protocol Layers 68

RS 193

RSSI 35

S

Save 83, 169-171

Save As 169

Saving 170-171

Display Filter 82

Imported Capture Files 181

Saving the Capture File using File > Save or the Save icon 169

Search 150, 152, 154, 156-157, 162, 165-167

binary value 152

bookmarks 167

character string 152

errors 162

event number 157

frame number 156

hex pattern 152

pattern 152

special event 157



timestamp 154

wildcards 152

Security

802.11 I/O Settings 19, 29

WPA Key 40

Seed Value 133

Short Break 138

Side Names 187

Sides 187

Slave 43

Sorting Frames 68

Special Events 157

Start 137

Start Up Options 184

Statistics 142

Statistics Graphs 146

Summary 74

Summary Pane 74-76

Sync Dropped 138

Sync Found 138

Sync Hunt Entered 138

Sync Lost 138

Synchronization 70

System Settings 181, 183

T

Technical Support 196

Test Device Began Responding 138

Test Device Stopped Responding 138

Timestamp 166, 189-190

Timestamping 166, 188, 190

Timestamping Disabled 138

Timestamping Enabled 138

Timestamping Options 181, 188

Timestamping Resolution 189

Timestamps 188, 190

Transferring Packets 49

Truncated Frame 138

U

Underrun Error 138

Unframe 60

Unframe Function 60

Unframing 60

Unknown Event 139

V

vendor specific decoder 195

Viewing Data Events 135

W

WEP 29

802.11 I/O Settings 19

Wi-Fi Timeline

Wi-Fi Error Statistics 146

WPA Key 29, 40

802.11 I/O Settings 19

WPA Key 40

Wrap Buffer/File 181

Z

Zooming 126

zooming cursor 116

