

Signal Recovery with PMTs

Application Note #4

Photon Counting, Lock-In Detection, or Boxcar Averaging?

Which instrument is best suited for detecting signals from a photomultiplier tube? The answer is based on many factors including the signal intensity, the signal's time and frequency distribution, and the various noise sources and their time dependence and frequency distribution.

In general, the choice between boxcar averaging (gated integration) and lock-in detection (phase sensitive detection) is based on the time behavior of the signal. If the signal is fixed in frequency and has a 50 % duty cycle, lock-in detection is best suited. This type of experiment commonly uses an optical chopper to modulate the signal at some low frequency. Signal photons occur at random times during the 'open' phase of the chopper. The lock-in detects the average difference between the signal during the 'open' phase and the background during the 'closed' phase.

To use a boxcar averager in the same experiment would require the use of very long (50 % duty cycle) gates, since the photons can arrive anywhere during the 'open' phase. Since the gated integrator is collecting noise during this entire gate, the signal is easily swamped by the noise. To correct for this, active baseline subtraction can be used, where an equal gate measures the background during the 'closed' phase of the chopper and is subtracted from the 'open' signal. This is identical to lock-in detection. However, lock-in amplifiers are much better suited to this: especially at low frequencies (long gates) and low signal intensities.

If the signal is confined to a very short amount of time, gated integration is usually the best choice for signal recovery. A typical experiment might be a pulsed laser excitation where the signal lasts for only a short time (100 ps to 1 μ s), at a repetition rate of 1 Hz to 10 kHz. The duty cycle of the signal is much less than 50 %. By using a narrow gate to detect signal only when it is present, noise which occurs at all other times is rejected. If a longer gate is used, no more signal is measured, but the detected noise will increase. Thus, a 50 % duty cycle gate would not recover the signal well, and lock-in detection is not suitable.

Photon counting can be used in either the lock-in or the gated mode. Using a photon counter is usually required at very low signal intensities, or when the use of a pulse height discriminator to reject noise results in an increased signal-to-noise ratio (SNR).

As seen in the illustration, the crossover point between analog detection and photon counting is never very distinct. Photon counting works well at very low count rates because the input discriminator virtually eliminates analog front-end noise. Analog detection works well at large count rates since the analog inputs do not saturate as easily as a counter. In the middle ground, the choice should be based on SNR considerations. At best, the achievable SNR is determined by

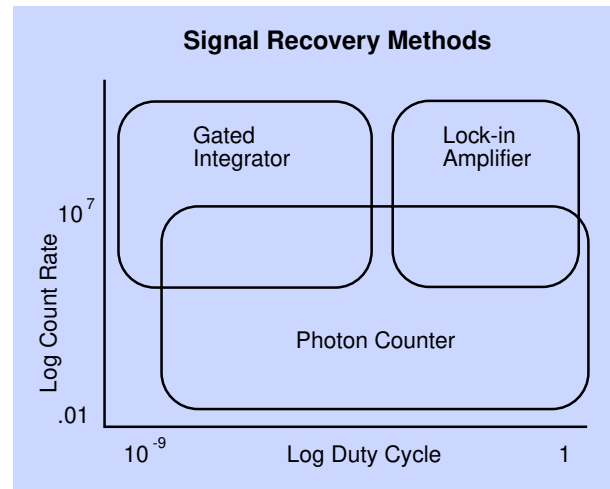

the statistical noise of the Poisson counting distribution. The analog instruments degrade the SNR due to input noise.

This applications note begins by discussing photomultiplier tubes and how to optimize their performance. The following sections discuss the SNR of the various signal recovery methods. Techniques are described which can extend the analog instruments into the 'photon counting' regime. However, these techniques have limits beyond which photon counting is preferred. Experimental data illustrating the achievable signal-to-noise ratios is presented.

Using Photomultiplier Tubes

Photomultiplier tubes (PMTs) are high-gain, low-noise, light detectors. They can detect single photons over a spectral range of 180 to 900 nm. Windowless PMTs can be used from the near UV through the X ray region, and may also be used as particle detectors.

Photons which strike the PMT's photocathode eject an electron by the photoelectric effect. This electron is accelerated toward the first dynode by a potential of 100 to 400 VDC. Secondary electrons are ejected when the electron strikes the first dynode, and these electrons are accelerated toward the second dynode. Typically, the process continues for 8 to 14 dynodes, each providing an electron gain of about 4 to 5, producing 10^6 to 10^7 electrons which are collected by the anode. If these electrons arrive in a 5 ns pulse into a 50 ohm load, they will produce a 1.6 mV to 16 mV pulse.

Geometry

There are two basic geometries for photomultiplier tubes: head-on and side-on types. The head-on type has a semitransparent photocathode and a linear array of dynodes. The head-on types offer large photocathodes with uniform sensitivity and lower noise. These PMTs must be operated at a higher voltage and are usually larger and more expensive than the side-on types. Side-on types have an opaque photocathode and a circular cage of dynodes.

Spectral Response

There are a variety of materials which are used as photocathodes: the work function of the photocathode will determine the spectral response (and will influence the dark count rate) of the PMT. For photon counting, the figure of merit is the "quantum efficiency" of the PMT. A 10% quantum efficiency indicates that 1 in 10 photons which strike the photocathode will produce a photoelectron; the rest of the incident photons will not be detected. The quantum efficiency is a function of wavelength, so select the PMT for the best quantum efficiency over the wavelength region of interest.

Gain and Rise Time

When using gated detection, it is important to select a PMT with sufficient gain and short rise time. Large gains are essential to both gated integrators and photon counters. For gated integrators, the pulse rise time and width should be on the order of the gate width (or less) so that timing information is not lost. For photon counting, the pulse width should be smaller than the pulse-pair resolution of the counter/discriminator to avoid saturation effects. When using lock-in amplifiers, pulse rise time is unimportant, while high gain extends the sensitivity of the measurement.

The criteria for a "detectable pulse" depends on the electrical noise environment of your laboratory and the noise of your preamplifier. In laboratories with Q-switched lasers or pulsed discharges, it is difficult to reduce the noise on any coaxial cable below a few millivolts. A good, wide-bandwidth preamplifier (such as the SR445) will have about 1.5 nV/ $\sqrt{\text{Hz}}$, or about 25 μVrms over its 300 MHz bandwidth. Peak noise will be about 2.5 times the rms noise, so it is important that the PMT provide pulses of at least 100 μV amplitude.

Use manufacturer's specifications for the current gain and rise time to estimate the pulse amplitude from the PMT using the following equation:

$$\text{Amplitude (mV)} = 4 \times \text{Gain (in millions)} / \text{Rise Time (ns)}$$

This formula assumes that the electrons will enter a 50 ohm load in a square pulse whose duration is twice the rise time.

(Since the rise time will be limited to 1.2 ns by the 300 MHz bandwidth of the preamplifier, do not use rise times less than 1.5 ns in this formula.)

If the PMT anode is connected via a 50 Ω cable to a much larger load ($R \gg 50 \Omega$), the cable termination looks like an open circuit. All of the charge in the pulse is deposited on the cable capacitance in 5 ns. The voltage on the load will be $V=Q/C$, where C =cable capacitance. This voltage will decay exponentially with a time constant of RC , where R =load resistance. In this case, the pulse height will be:

$$\text{Amplitude (mV)} = 160 \times \text{Gain (in millions)} / \text{Cable C (pF)}$$

The current gain of a PMT is a strong function of the high voltage applied to the PMT. Very often, PMTs will be operated well above the high voltage recommended by the manufacturer, and thus substantially higher current gains (10x to 100x above specs). There are usually no detrimental affects to the PMT as long as the anode current is kept well below the rated value.

Dark Counts

PMTs are the quietest detectors available. The primary noise source is thermionic emission of electrons from the photocathode, and from the first few dynodes of the electron multiplier. PMT housings, which cool the PMT to about -20°C , can dramatically reduce the dark counts (from a few kHz to a few Hz). The residual counts arise from radioactive decays of materials inside the PMT, and from cosmic rays.

PMTs which are specifically designed for photon counting will specify their noise in terms of the rate of output pulses whose amplitudes exceed some fraction of a pulse from a single photon. More often, the noise is specified as an anode dark current. Assuming the primary source of dark current is thermionic emission from the photocathode, the dark count rate is given by:

$$\text{Dark Count (kHz)} = 6 \times \text{Dark Current (nA)} / \text{Gain (millions)}$$

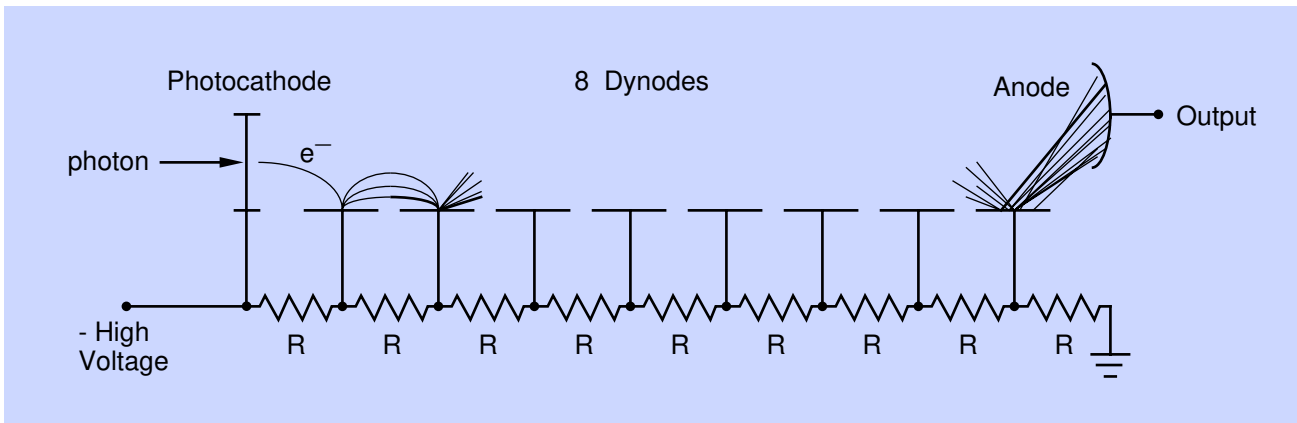

PMT Base Design

PMT bases, which are designed for general purpose applications, are not appropriate for photon counting or fast gated integrator applications (gates <10 ns). General purpose bases will not allow high count rates, and often cause problems such as double counting and poor plateau characteristics. A PMT base with the proper high voltage taper, bypassing, snubbing and shielding is required for good time resolution and best photon counting performance.

CAUTION! Lethal high voltages are used in PMT applications. Use extreme caution when working with these devices. Only those experienced with high voltage circuits should attempt any of these procedures. Never work alone.

Dynode Biasing

A PMT base provides bias voltages to the PMT's photocathode and dynodes from a single, negative, high-voltage power supply. The simplest design consists of a resistive voltage divider (see figure on previous page).

In this configuration, the voltage between each dynode, and thus the current gain at each dynode, is the same. Typical current gains are three to five, so there will typically be four electrons leaving the first dynode, with a variance of about two electrons. This large relative variance (due to the small number of ejected electrons) gives rise to large variations in the pulse height of the detected signal. Since statistical fluctuations in pulse height are caused by the low gain of the first few stages of the multiplier chain, increasing the gain of these stages will reduce pulse height variations and improve the pulse height distribution. This is important for both photon counting and analog detection. To increase the gain of the first few stages, the resistor values in the bias chain are tapered up to increase the voltage in the front end of the multiplier chain. The resistor values are tapered slowly so that the electrostatic focusing of electrons in the multiplier chain is not adversely affected.

Current for the electron multiplier is provided by the bias network. Current drawn from the bias network will cause the dynode potentials to change, thus changing the tube gain. This problem is of special concern in lifetime measurements. The shape of exponential decay curves will be changed if the tube gain varies with count rate. To be certain that this is not a problem, repeat the measurement at half the original intensity.

The problem of gain variation with count rate is avoided if the current in the bias network is about 20 times the output current from the PMT's anode.

Example: If a PMT is operated so that it gives 20 mV pulses of 5 ns duration into a 50 ohm load, then the average current at 50 MHz count rate will be 0.1 mA. If the bias resistors are chosen such that the chain current is $20 \times 0.1 \text{ mA} = 2 \text{ mA}$, the PMT's gain will remain constant vs. count rate. If this PMT is operated at 2500 VDC, the power dissipated in this base is 5 W.

There are a few other methods to avoid this problem which do not require high bias-currents. These methods depend on the fact that the majority of the output current is drawn from the last few dynodes of the multiplier. The methods are as follows:

- (1) Replace the last few resistors in the bias chain with Zener diodes. As long as there is some reverse current through a Zener, the voltage across the diodes is nearly constant. This will prevent the voltage on these stages from dropping as the output current is increased.
- (2) Use external power supplies for the last few dynodes in the multiplier chain. This approach dissipates the least amount of electrical power since the majority of the output current comes from lower voltage power supplies. However, it is the most difficult to implement.
- (3) If the average count rate is low, but the peak count rate is high, then bypass capacitors on the last few stages may be used to prevent the dynode voltage from dropping (use $20 \times$

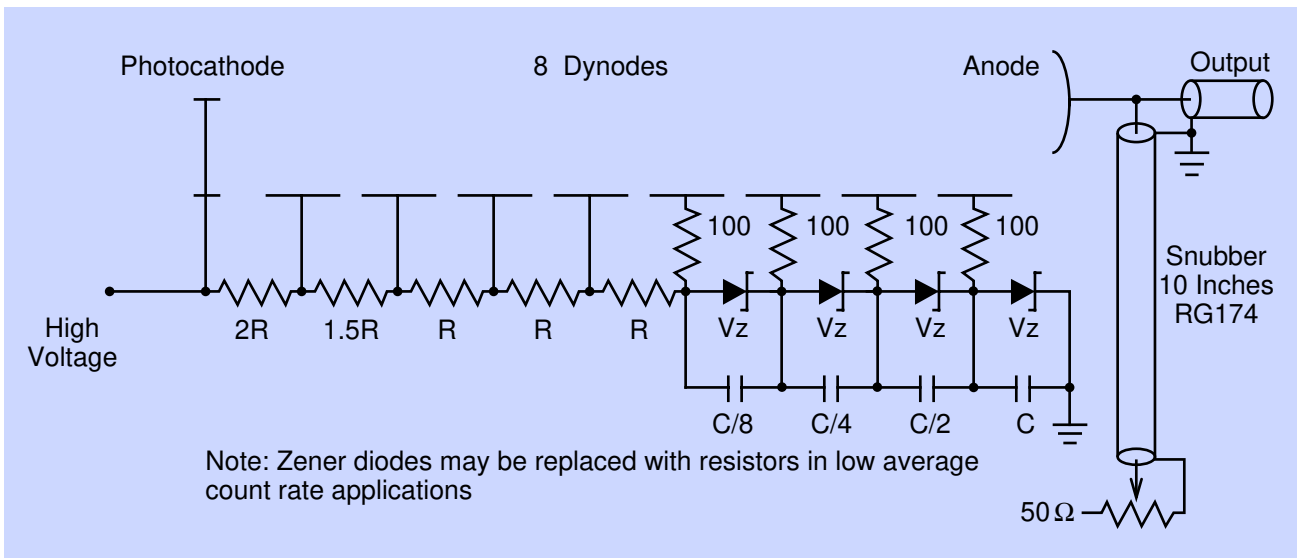

the average output current for the chain current).

For a voltage drop of less than 1 %, the stored charge on the last bypass capacitor should be 100× the charge output during the peak count rate. For example, the charge output during a 1 ms burst of a 100 MHz count rate, each with an amplitude of 10 mV into 50 ohms and a pulse width of 5 ns, is 0.1 μC. If the voltage on the last dynode is 200 VDC, then the bypass capacitor for the last dynode should have a value given by:

$$C = 100 \text{ Q/V} = 100 \times 0.1 \text{ } \mu\text{C} / 200 \text{ V} = 0.05 \text{ } \mu\text{F}$$

The current from higher dynodes is smaller, so the capacitors bypassing these stages may be smaller. Only the final four or five dynodes need to be bypassed—usually with a capacitor which has half the capacitance of the following stage. To reduce the voltage requirement for these capacitors, they are usually connected in series. (See diagram on previous page.)

Bypassing the dynodes of a PMT may cause high frequency ringing of the anode output signal. This can cause multiple counts for a single photon, or poor time resolution in a gated integrator. The problem is significantly reduced by using small resistors between the dynodes and the bypass capacitors, as shown in the diagram.

Snubbing

Snubbing refers to the practice of adding a network to the anode of the PMT to improve the shape of the output pulse for photon counting or fast gated integrator applications. This 'network' is usually a short piece of 50 ohm coax cable which is terminated into a resistor of less than 50 ohms. Snubbing should not be used when using a lock-in amplifier since the current conversion gain of a 50 ohm resistor is very small.

There are four important reasons for using a snubber network:

- (1) Without some DC resistive path between the anode and ground, anode dark current will charge the signal cable to a few hundred volts (last dynode potential). When the signal cable is connected to an amplifier, the stored charge on the cable may damage the front-end of the instrument. If you decide not to use a snubber network, install a 10 MΩ to 100 MΩ resistor between the anode and ground to protect your instruments.
- (2) The rise time of the output current pulse is often much faster than the fall time. A snubber network may be used to sharply reduce the fall time, greatly improving the pulse-pair resolution of the PMT.
- (3) Ringing (with a few nanosecond period) is very common on PMT outputs (especially if the final dynode stages are bypassed with capacitors). A snubber network may be used to cancel these rings which can cause multiple counts from a single photon.
- (4) The snubber network will help to terminate reflections from the input to the preamplifier.

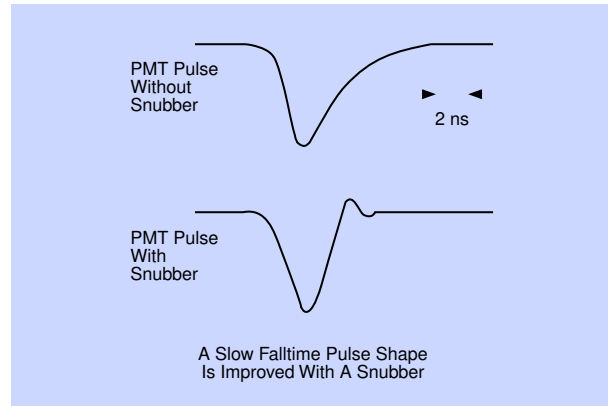

A good starting point for a snubber network is a 10 inch piece of RG174/U coax cable with a small 50 ohm pot connected to the end so that the terminating impedance may be adjusted from 0 to 50 ohms. (A 10 inch cable will have a round trip time of about 5 ns—be sure your PMT has a rise time less than this.) The other end of this cable is connected to the anode of the PMT, together with the output signal cable.

Output current pulses will split: 50 % going out the signal cable, and 50 % going into the snubber. If the snubber pot is adjusted to 50 ohms, there will be no reflection; the only effect the snubber has is to attenuate the signal by a factor of two.

The reflection coefficient for a cable with a characteristic impedance R_0 , terminated into a resistance R_t , is given by:

$$\text{Reflection Coefficient} = (R_t - R_0) / (R_t + R_0)$$

If the pot is adjusted to a value below 50 ohms, then some portion of the signal will be inverted and reflected back toward the anode. This reflected (and inverted) signal is delayed by the round trip time in the snubber cable and sent out the signal cable. The amount of the reflection is adjusted for the best pulse shape as shown.

The round trip time in the snubber cable may be adjusted so that the reflected signal cancels anode signal ringing. This is done by using a cable length with a round trip time equal to the period of the anode ringing.

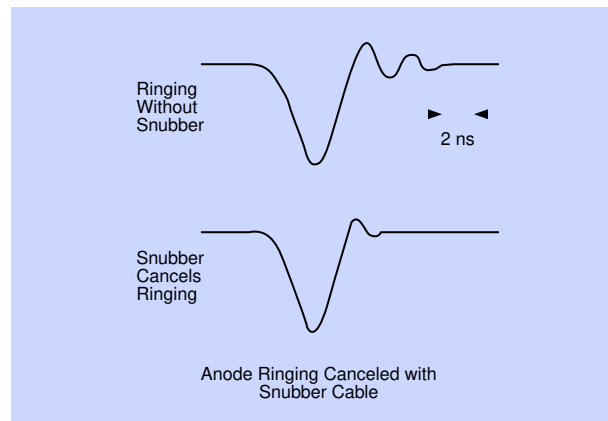

Cathode Shielding

Head-on PMTs have a semitransparent photocathode which is operated at negative high voltage. Use care so that no objects near ground potential contact the PMT near the photocathode.

Magnetic Shielding

Electron trajectories inside the PMT will be affected by magnetic fields. A field strength of a few Gauss can dramatically reduce the gain of a PMT. A magnetic shield made of a high permeability material should be used to shield the PMT.

PMT Base Summary

- (1) Taper voltage divider for higher gain in first stages.
- (2) Bypass last few dynodes in pulsed applications.
- (3) Use a snubber circuit to shape the output pulse for photon counting or fast gated integration.

Gated Photon Counting

Gated photon counting measures the intensity of a signal by counting the number of photons which are detected by the PMT in a given time gate. This is sometimes referred to as a 'boxcar' mode. In concept, gated photon counting is identical to gated integration except that only PMT pulses which exceed a certain discriminator threshold level are counted.

Due to the statistical nature of the secondary emission process, there is a distribution of signal pulse heights coming from the PMT. There is another distribution of noise pulse heights. Noise which results from thermionic emission from the photocathode can not be distinguished from signal. However, noise pulses from dynode thermionic emission will have a lower mean pulse-height. The PMT should be operated at sufficient high voltage that the mean signal pulse-height is well above the pulse height of other noise sources such as preamp noise and EMI pickup.

There are two reasons for carefully selecting the input discriminator level:

- 1) To improve the signal-to-noise ratio by setting the discriminator level above most of the noise pulses but below most of the signal pulses.
- 2) To reduce drift. If the discriminator threshold is set to the top of the signal pulse height distribution, then small changes in the tube gain can cause a large change in the count rate.

Gain Requirement

The output of a PMT is a current pulse. This current is converted to a voltage by a load resistor. One would like to use a large resistor to get a large voltage pulse. However, in photon counting it is important to maintain a high bandwidth for the output signal. Since charge on the anode is removed by the load resistance, smaller load resistances increase the

bandwidth. The bandwidth of a 10 pF anode with a 100 ohm load is 300 MHz.

For convenience, 50 ohm systems are usually used. The current pulse from the PMT travels down a 50 ohm cable which is terminated by the 50 ohm input impedance of a preamplifier. The attenuation of RG-58 coax cable at 300 MHz is about 1 dB/10 foot, and does not significantly degrade performance in this application.

To allow counting to 200 MHz, a preamplifier with a bandwidth which is somewhat larger than 200 MHz is required. The SR445 preamplifier has four 5× gain amplifiers, each with 50 ohm input impedance and 300 MHz bandwidth. The amplifiers may be cascaded for gains of 5, 25 or 125.

The SR400 Photon Counter can detect pulses as low as 2 mV. To allow for some adjustment of the discriminator threshold and to provide better noise immunity, a more practical lower limit on pulse size is about 10 mV. The highest discriminator level which may be set is 300 mV. The preamplifier should have enough gain to amplify anode pulses to between 10 mV and 300 mV (100 mV is a good target value).

Using the result that pulse height (in mV) is about four times the tube gain (in millions) divided by the rise time (in ns), a PMT with a gain of 4 million and a rise time of 2 ns will provide 8 mV output pulses. Half of the pulse amplitude will be lost in the anode snubber, so a gain of 25 is required to boost the output pulses to 100 mV.

Setting the Discriminator Level

There is no exact prescription for setting the discriminator threshold; the procedure used will depend somewhat on the nature of the measurement. If dark counts are a problem then the discriminator level should be set higher than when drift is a concern. If the PMT is cooled (reducing thermionic emission), then a lower discriminator level is probably okay. If the PMT has a ring on the anode signal, the discriminator level should be set high enough so that the rings are not counted.

The 'Correct' Way

The tube should be operated at the maximum high voltage recommended by the manufacturer. Use enough preamplifier gain so that the single photon pulse-height is about 100 mV. Provide enough light to the PMT for a count rate of a few megahertz. Using a 300 MHz oscilloscope, adjust the snubber termination for minimum ringing on the anode signal. Take the pulse-height spectrum of the anode signal by scanning the discriminator level and plotting count vs. discriminator level. If the PMT dark count rate is a concern, you will also need to take the pulse-height spectrum of the dark count signal. It will take much longer to take the dark count spectrum because the count rate should be much lower. The object is to find a discriminator level which is higher than the mean noise-pulse height, and below the mean signal-pulse height.

The 'Fast and Pretty Good' Way

This technique works very well and is particularly suited for those who do not want to make a career out of plateauing their PMTs. The PMT should be operated at (or a bit above) the recommended maximum high voltage. Provide enough illumination for a count rate of a few megahertz, and enough preamp gain to get pulse heights of about 100 mV. Using a 300 MHz oscilloscope, adjust the snubber termination impedance for the best pulse shape. Look carefully at the anode pulse shape, and set the discriminator to a level which is above any ringing but well below the mean pulse height. If there is lots of EMI or amplifier noise, increase the PMT's high voltage to increase the signal pulse height.

Signal-to-Noise

The probability that n photons will be detected in a time t is described by the Poisson distribution:

$$P(n,t) = (Kt)^n e^{-Kt} / n!$$

where K is the average photon rate.

The standard deviation of any measurement is \sqrt{N} , where N is the number of photons detected. If many measurements of gate width T are made, the standard deviation of the data points will be $\sqrt{N_s}$, where N_s is the average number of photons detected in a single measurement. The signal-to-noise ratio (SNR) is simply $N_s/\sqrt{N_s} = \sqrt{N_s}$. If each data point instead consists of the sum of M measurements of gate width T , then the standard deviation will be $\sqrt{N_t}$, where $N_t = MN_s$. The SNR of this measurement is $\sqrt{N_t} = \sqrt{M} \times \sqrt{N_s}$ and is \sqrt{M} better than the single gate measurement.

Because photon counters have a maximum count rate or pulse-pair resolution limit, they can be saturated. The probability that a photon will be counted is equal to the probability that no photon arrived in the previous time t , where t is the pulse-pair resolution. If K is the total photon rate, then each photon is detected with probability e^{-Kt} . As Kt increases, eventually the number of detected photons will decrease as the PMT pulses are no longer distinct single photon pulses.

Assuming that the signal photon rate is K_s and the background or noise rate is K_b , then the detected signal is:

$$\text{SIGNAL COUNT} = K_s T e^{-(K_s + K_b)T}$$

where T = gate width and t = pulse-pair resolution.

The total output count is:

$$\text{TOTAL COUNT} = (K_s + K_b) T e^{-(K_s + K_b)T}$$

The deviation of the total count is:

$$(\text{TOTAL}) = [(K_s + K_b)T]^{1/2} \times [1 + (K_s + K_b)^2 Tt]^{1/2} \times e^{-(K_s + K_b)T}$$

The SNR is just SIGNAL/(TOTAL) or:

$$\text{SNR} = \frac{K_s T}{[(K_s + K_b)T]^{1/2} [1 + (K_s + K_b)^2 Tt]^{1/2}}$$

Define:

$$\begin{aligned} N_s &= K_s T = \text{signal photons in gate } T \\ N_b &= K_b T = \text{background photons in gate } T \\ n &= (K_s + K_b)t = \text{total photons in time } t \\ &\quad (\text{pulse-pair resolution}) \end{aligned}$$

Using these definitions, the SNR is given by:

$$\text{SNR} = \frac{\sqrt{N_s}}{[1 + N_b/N_s]^{1/2} [1 + (N_s + N_b)n]^{1/2}}$$

The SNR is plotted below for small N_b . If N_b and n are both small, then $\text{SNR} = \sqrt{N_s}$ as discussed before. If n , the number of photons expected to occur in one pulse-pair resolution time, is large, then $\text{SNR} \cong 1/\sqrt{n}$ and decreases with increasing count rate.

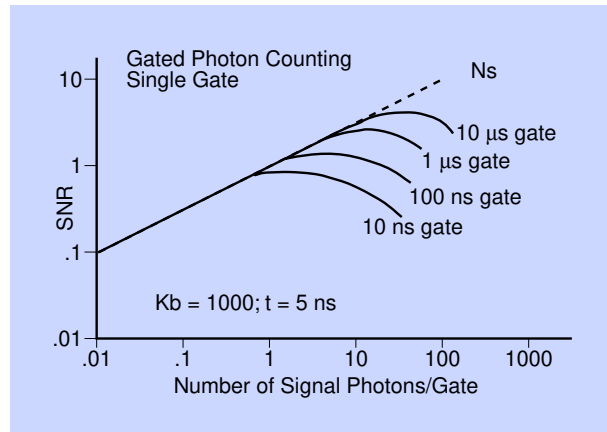

If $N_b \gg N_s$, then $\text{SNR} \cong N_s/\sqrt{N_b}$. This simply means that the output noise is due to the statistics of the background counts and that the signal must exceed the deviations in the background. For example, if $N_b/N_s = 10$, then the $\text{SNR} = 1$ when the total number of signal photons counted is 10 and the total background count is 100. In this case, the counts from many gates may need to be summed together to achieve this.

Experimental data (next page) demonstrates how the SNR grows as \sqrt{N} , where N is the total number of counts per data point. An R928 photomultiplier tube with a tapered base and snubber was used with a pulsed light source. The average pulse height from the PMT was about 15 mV into a 50 Ω termination. An SR400 Gated Photon Counter was used to collect the data. The discriminator level was set to 7 mV. The intensity of the signal was adjusted to provide an average of one signal photon per 100 ns gate. The counts from a number of gates, T_{set} , are summed together in each data point. Data is

plotted for $T_{set} = 100, 200$ and 400 gates. In between each data set, the signal was turned off and only background data collected. For each T_{set} , y =average counts/data point; dy =standard deviation; $SNR=y/dy$.

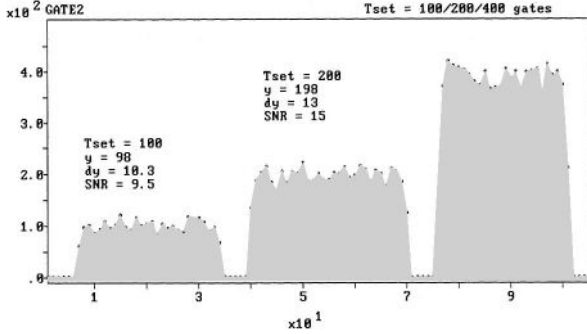

S/N ratio for different total counts

Note that the background rate is very small and does not result in any counts when the signal is off.

A tradeoff must be made between SNR and the length of time each data point takes to accumulate. The SNR for 400 gates is twice that of 100 gates, but the 400 gate points take four times as long to acquire (SNR grows as \sqrt{M} where $M = \#$ of gates). Clearly the data could be smoothed and averaged off line to improve the SNR. However, in a scanning experiment, a signal feature may only be one or two data points. Each point will be within one or two standard deviations of the average of many points, and thus, the signal may be characterized as having error bars of $\pm N$.

Boxcar Averaging

Boxcar averaging, or gated integration, is an analog measurement where the signal is averaged over a short time gate, and the results of many gates are averaged together. Since no discriminator is used, the variation in signal pulse height results in output deviations. Therefore, unlike the photon counter, the output noise will be greater than the \sqrt{N} , due to counting statistics because of the pulse-to-pulse height fluctuations.

The signal output of a gated integrator for a signal photon rate of K_s is:

$$\text{SIGNAL} = (1/T) K_s T A e R \text{ (volts)}$$

where T is the gate width, A is the PMT gain, e is the electron charge, and R is the termination resistance of PMT.

This assumes that the PMT output pulses are shorter in duration than T . ($K_s T$) is the number of photons which arrive in the gate, and AeR/T is the voltage of a single pulse averaged over the gate.

The total output of the gated integrator is:

$$\text{OUTPUT} = (1/T)(K_s + K_b)TAeR + V_n \text{ (volts)}$$

where K_b is the background photon rate and V_n is the input voltage noise of the gated integrator.

Pulses from a PMT have an amplitude variation due to the statistics of the charge multiplication process. In addition, the number of photons detected varies as \sqrt{N} . Both effects are described by the Polya distribution:

$$\Delta(K_s TA) = \Delta(NA) = A\sqrt{N} \left[\frac{\xi}{(\xi - 1)} \right]^{1/2}$$

where ξ is the dynode gain per stage.

As ξ becomes large, $\Delta(NA)$ approaches $A\sqrt{N}$ which indicates that the PMT should be operated at the highest voltage (gain) possible. The pulse-height variation results in output noise above the \sqrt{N} counting noise. For example, if $A=10^7$ with 14 stages, $\xi = 3.16$ and $\Delta(NA) = 1.2 A\sqrt{N}$.

Using the above example,

$$\Delta(\text{Output}) = \left[\left(\frac{1.5}{T^2} \right) (K_s + K_b) T A^2 R^2 e^2 + \Delta V_n^2 \right]^{1/2}$$

and the SNR is:

$$\text{SNR} = \frac{0.8\sqrt{N_s}}{\left[1 + \frac{N_b}{N_s} + \frac{V_n^2 T}{1.5 N_s A^2 R^2 e^2} \right]^{1/2}}$$

where $N_s = K_s T$ = number of signal photons which arrive in the gate, $N_b = K_b T$ = number of background photons during the gate and V_n = input noise density (volts/ $\sqrt{\text{Hz}}$).

Note that the observed input voltage noise will decrease as $1/\sqrt{T}$ as the gate width is increased.

Assume a short gate such that N_b is negligible. When the statistical deviation in the number of photons observed ($\sqrt{N_s}$, which yields a noise voltage equal to $\sqrt{N_s} AeR/T$) exceeds the averaged input noise over the gate (V_n/\sqrt{T}), we are in the 'photon counting' regime. In this case, $\text{SNR} \cong 0.8\sqrt{N_s}$. The 0.8 factor is due to the amplitude variation of the pulses. (If the tube gain is 10^6 , the factor is 0.56) However, unlike photon counting, there are no saturation effects at high count rates. In addition, since there is no discriminator, smaller photon pulses contribute to the output increasing N_s and offsetting some of the pulse-height variations.

When the input noise dominates, $V_n/\sqrt{T} \gg \sqrt{N_s}(AeR/T)$ and $\text{SNR} < 0.8\sqrt{N_s}$. Note that for a constant number of photons, making the gate longer decreases the SNR. This is because the

noise voltage will decrease as $1/\sqrt{T}$ (Gaussian) while the signal is decreasing by $1/T$ (linear averaging).

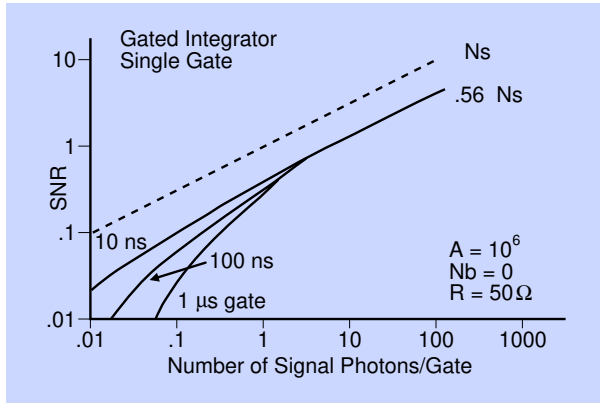

The SNR is plotted above for a single gate. In all cases, averaging over M gates increases SNR by \sqrt{M} . This can be seen by replacing N_s with MN_s and T with MT .

For large signals, it is clear that while the photon counter will saturate, the boxcar averager will work just fine. The fact that the achievable SNR is less than \sqrt{N} is not important since the only way to improve the SNR is to attenuate the signal to a few photons per gate and count photons for many gates. The inconvenience of the longer measurement times usually far offsets the small gain in SNR which would result from counting.

For small signals (from one to much fewer than one photon per gate) and gates greater than 10 ns, photon counting is usually better.

Experimental data acquired with an SR250 Boxcar Averager is shown below. The same signal and PMT which was used in the photon counting example were used here. The sensitivity was set to 1 V / 5 mV, and the average photon pulse had an amplitude of 15 mV. An average of 1 photon per 100 ns gate is collected and the averaging is over 100 gates.

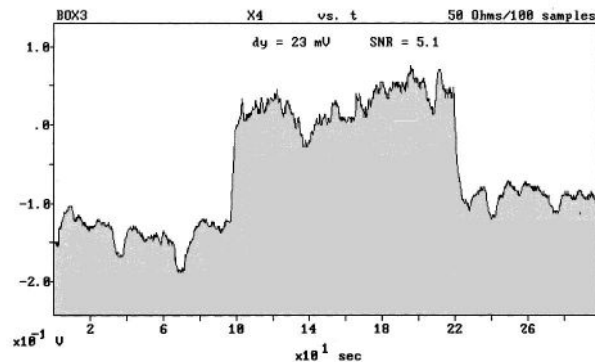

SNR ratio for boxcar integration

The SNR is only 5:1, while in the 100-gate photon counting case it was 9.5:1. In fact, the boxcar is even worse. Since the

100 gate average is exponential, the number of gates required for the signal to go from zero to full scale is 300 to 500. In the photon counting case, the signal reaches full scale after 200 gates. Because of this, in a scanning experiment, the photon counter could scan twice as fast and achieve twice the SNR.

Since the output noise is independent of whether there is any signal, the boxcar SNR is dominated by the input voltage noise. The SNR can be improved by increasing the size of the PMT pulses. This can be done with an SR240 preamplifier which has a lower input noise than the boxcar averager. When the gate is long, simply increasing the termination resistance can go a long way to increasing the SNR. Choose a resistance that does not widen the PMT pulses beyond about half of the gate width. Otherwise, timing information will be lost. In this experiment, a 200 Ω resistance increased the pulse amplitude by four and brought the SNR into the 'photon counting' regime as shown below.

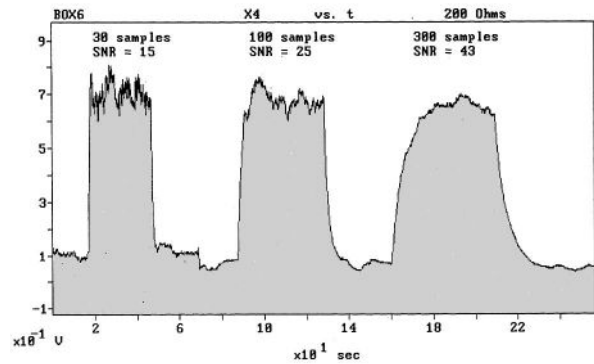

SNR ratio for 200 Ω terminating impedance

The baseline noise is now negligible compared to the signal, and the 100-gate data now has a SNR of 25. Increasing the averaging increases the SNR by $\sqrt{\text{samples}}$. As discussed before, averaging over 100 samples should be compared to photon counting for about 30 samples, since the signal rises to full scale in fewer data points for photon counting.

Synchronous Photon Counting

If a signal is fixed in frequency and has a 50 % duty cycle, then synchronous photon counting, or photon counting in a 'lock-in' mode, can be used. These signals usually result from the use of an optical chopper or other periodic excitation. The photon counter uses two counting channels and one PMT. Both counting channels use the one PMT as their signal source. The A counter counts pulses during the 'open' phase of the chopper and thus counts signal plus background. The B counter counts pulses only during the 'closed' cycle of the chopper and only counts the background. The difference between the two counts, $A-B$, is the signal. Accumulating data over many cycles is required to measure the signal, since the background rate usually far exceeds the signal rate.

Assume that the total photon rate is small ($K \ll 100$ MHz) such that saturation can be ignored. Then the signal count is:

$$\text{SIGNAL COUNT} = K_s T_1$$

where $T_1 = \text{the open cycle} = \frac{1}{2} \text{ period of the chopper frequency}$.

The A-B count is:

$$\text{A-B COUNT} = (K_s + K_b)T_1 - K_b T_2$$

where $T_2 = \text{the closed cycle} \gg T_1$.

The noise in the A-B count is:

$$\Delta(\text{A-B}) = \sqrt{N_s + 2N_b}$$

where $N_s = K_s T_1 = \text{the average number of signal photons counted during } T_1$, and $N_b = K_b T_1 = K_b T_2 = \text{the average number of background photons counted during } T_1 \text{ or } T_2$. Even though $K_b T_1 = K_b T_2$, the noise in the output due to K_b is not zero, since in a given measurement the number of background counts detected during T_1 differs from the number detected during T_2 by $\sqrt{2} \sqrt{N_b}$ ($\sqrt{N_b}$ is the uncertainty in N_b during each cycle.) The cancellation of the background improves as the number of background counts detected increases and is the dominant factor in the SNR.

The SNR is:

$$\text{SNR} = \frac{N_s}{(N_s + 2N_b)^{1/2}}$$

If $N_b \ll N_s$, then $\text{SNR} = \sqrt{N_s}$ as expected.

If $N_b \gg N_s$, then SNR is:

$$\text{SNR} = \frac{N_s}{(2N_b)^{1/2}}$$

In this case, the noise is the uncertainty in the measurement of the background rate. For example, if $N_b/N_s = 10$, the $\text{SNR} = 1$ only after $N_s = 20$ and $N_b = 200$. This can be achieved by adding the results of many cycles together or increasing the count rate.

A plot of SNR vs. total number of signal photons counted for several values of N_b/N_s is shown below. For a given

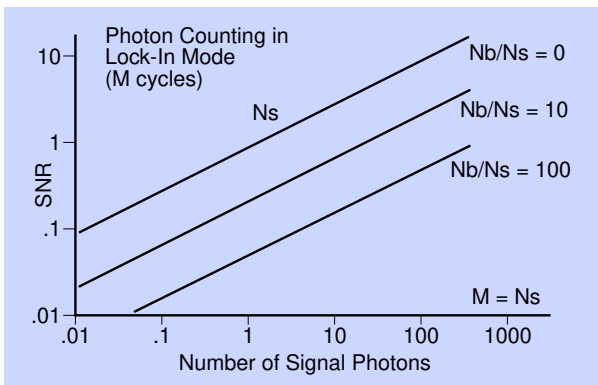

$N_s = \text{average number of signal photons per cycle}$, the larger the background, the longer the data acquisition will take.

Experimental data is presented in the following figures which show that the SNR is determined by the background rate when $N_b > N_s$. The PMT and signal source from the gated experiments were used. The signal was gated on for 10 ms at a repetition rate of 50 Hz (50 % duty cycle). The signal amplitude was adjusted to provide an average of one signal photon per cycle (50 photons/s). The background rate of dark counts was about 100 counts/s. The SR400 Photon Counter is configured for counting A-B, where counter A is gated on during the signal phase, and counter B is gated on during the background phase. Both counters were gated on for 9 ms.

The plots below show data accumulated for 50, 200 and 400 cycles. Note that the noise is basically independent of whether the signal is on or off. This is because $2N_b > N_s$. The SNR improves as \sqrt{M} , where $M = \text{number of cycles}$ as the deviations in the background count become less than the signal itself.

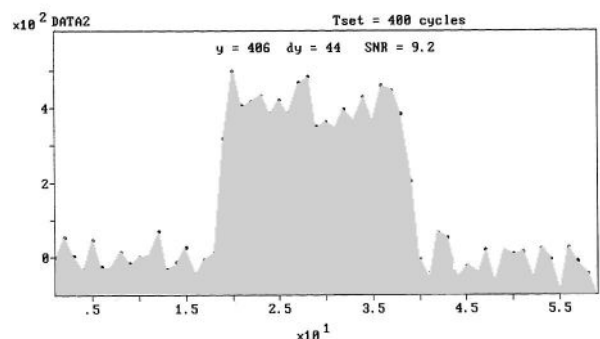
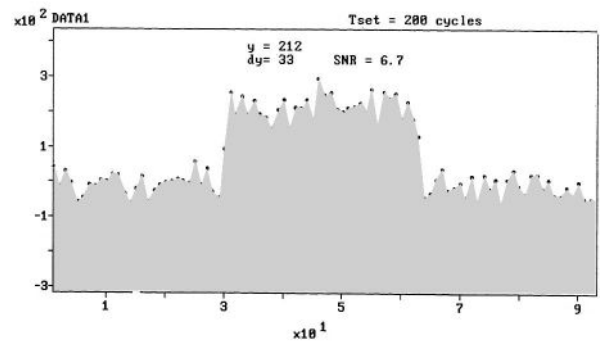
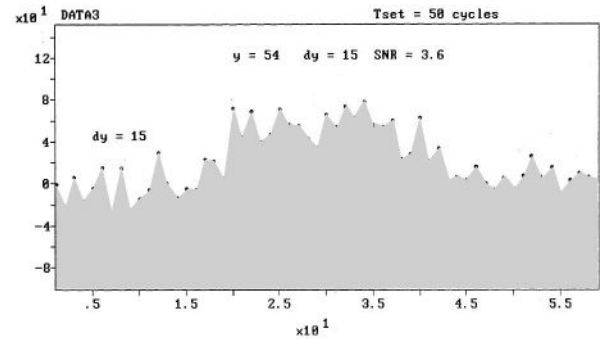

Lock-In Detection

Can a lock-in amplifier detect a single photon per reference cycle? In the previous photon counting experiment, the signal was about one photon per cycle at 50 cycles/second. This is a PMT current of $50Ae$ where A is the PMT gain. For $A=10^7$, the current is 80 pA (within the capability of most lock-ins).

A lock-in amplifier detects current by using a large resistor, or current amplifier, to convert the signal current into a voltage. When detecting single photon signals from a PMT, a well chosen termination resistor can provide signal-to-noise ratios governed entirely by the counting statistics of the photons.

Typically, a PMT output consists of a coaxial cable terminated by a 50Ω resistor. The output voltage appears across the resistor. Since the output cable is terminated in its characteristic impedance, the output voltage pulse will be $V_o \approx AeR/\Delta t$, where Δt is the pulse width of the PMT. For $A=10^7$ and $\Delta t=5$ ns, $V_o \approx 16$ mV. Now assume that one photon is detected per cycle at exactly the same time during each cycle. In the time domain, the signal is a periodic series of delta functions spaced by the reference period T , where T is much greater than Δt . In the frequency domain, the signal spectrum is a series of delta functions spaced by $1/T$ and extends from DC to $1/\Delta t$. In the case where $\Delta t=5$ ns, the spectrum extends to 200 MHz. A lock-in amplifier which is locked to $f=1/T$ is not suited to detecting this signal, not because of the amplitude, but because of the frequency spectrum.

Now suppose the output of the PMT is terminated by a high resistance ($R \gg 50 \Omega$). Because the cable is terminated in a high impedance, the cable can be modeled solely by its capacitance C . The charge from the PMT pulse is deposited on the capacitance in time t . The voltage on the cable will be $V_o = Ae/C$. The charge bleeds away through R over many time constants ($\tau=RC$). Thus, a photon arriving at time $t=0$ results in an output voltage waveform $V(t) = V_o e^{-t/\tau}$. Note that the amplitude of the pulse does not vary with R . The large R serves to lengthen the pulse width which changes the frequency spectrum of the pulse. The frequency spectrum now has components to much greater than $1/RC$. If $C=100$ pF and $R=10^7 \Omega$, the pulse amplitude is 1.6 mV. The frequency spectrum extends from DC to $\gg 1$ kHz and has a larger component at 50 Hz for the lock-in to detect.

The signal output of the lock-in can be estimated by considering a square wave multiplier and a periodic photon train at the reference frequency as shown below.

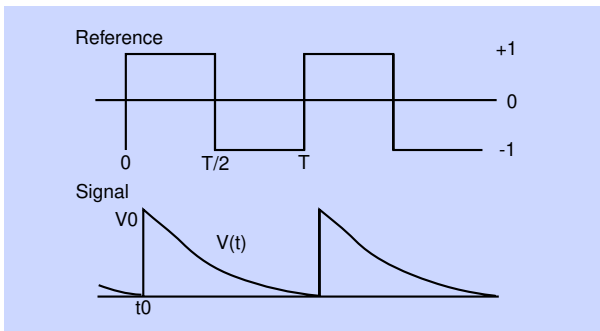

The DC output of the lock-in over one cycle is:

$$S(t_0) = \frac{V_o}{T} \int_0^T e^{-t/\tau} dt \quad (\text{volts})$$

Since real photons arrive at a random t_0 between 0 and $T/2$, the response for a random photon is:

$$S = \frac{2}{T} \int_0^{T/2} S(t_0) dt_0 \quad (\text{volts})$$

$$S = \frac{\tau}{T} (1 - e^{-T/\tau}) - \frac{4\tau^2}{T^2} (1 - e^{-T/2\tau})^2 \quad (\text{volts})$$

S is the response for an average of one photon arriving at a random time during each reference cycle. If $\tau \gg T$, then $S \gg 0$ because the RC time constant of the PMT output attenuates signals at the reference frequency. If $\tau \ll T$, then $S \gg 0$ because the signal extends to frequencies far greater than the reference frequency.

S maximizes for $\tau = T/6$, at which point $S=0.065V_o$. The factor 0.065 is due to the fact that the signal has many frequency components other than $1/T$, as well as a randomly shifting phase. Thus, the signal output of the lock-in is

$$\text{SIGNAL} = 0.065N_s Ae/C \quad (\text{volts})$$

where N_s is the average number of signal photons per cycle and C is the cable capacitance.

For $T=20$ ms (50 Hz), $C=100$ pF, $R=30$ M Ω , $N_s=1$, and $A=10^7$, the signal will be 1 mV.

The shunt resistor method is simple and easy to implement; however, phase information is lost. In many experiments phase is not important. When phase measurements must be made, a current preamplifier is used. The current preamplifier eliminates the cable capacitance, and the bandwidth of the amplifier is determined by the capacitance of the current gain resistor. Since this capacitance is much smaller, the time constant of the amplifier output pulse is much shorter than the case discussed above. Assuming that the reference period is much longer than this time constant, $T \gg \tau$, then the above formula applies and $S \approx V_o \tau/T$ and $V_o = Ae/C$, where C is the capacitance of the current conversion resistor. Since $\tau = RC$, where R is the current gain, then $S = AeR/T$ which is just the average current times the current gain resistor. The output signal will be:

$$\text{SIGNAL} = N_s AeR/T \quad (\text{volts})$$

For the conditions stated above, the signal will be 2.4 mV. A disadvantage of this approach is that the output of the current preamplifier is a pulse of much greater amplitude and shorter duration than the simple shunt resistor. This requires using higher dynamic reserve, so high-frequency components of the pulse do not overload the amplifier.

The output of the lock-in when there are background photons is:

$$\text{OUTPUT} = (0.065Ae/C)(N_s + N_b - N_2) + V_n \text{ (volts)}$$

where N_1 is the number of background photons detected during the open cycle, and N_2 is the number detected during the closed cycle. V_n is the noise voltage of the current conversion resistor:

$$\text{SNR} = \frac{N_s}{\left[N_s + N_b + \frac{V_n^2}{\Delta T (0.065Ae/C)^2} \right]^{1/2}}$$

The signal to noise ratio is:

where N_s and N_b are the number of signal and background photons which occur during a lock-in output time constant ΔT , and $V_n = 0.13\sqrt{R} \text{ nV}/\sqrt{\text{Hz}}$ is the Johnson noise density of the conversion resistor.

If N_s or N_b is large, the SNR is identical to the photon counting case described in the previous section, where data is accumulated for M cycles and $\Delta T \gg M$ reference cycles. If V_n dominates, the SNR is worse than pure counting statistics. However, the Johnson noise of large resistors is very small and does not limit many measurements. For example, a 30 M Ω resistor has a noise voltage of 2 μV (for $\Delta T = 1 \text{ s}$), while the signal due to 50 photons/s is 1 mV. In fact, in this example, as long as one background photon is detected per second, the SNR will be dominated by counting statistics. In all cases, the SNR increases as $\sqrt{\Delta T}$, where ΔT is lock-in time constant. This is because more photons are detected, and the statistical counting noise is reduced.

Experimental data is shown below. The signal source and PMT were the same as in the previous photon counting discussion. A 30 M Ω resistor was used to terminate the PMT output. An SR530 dual phase lock-in was used to measure signal magnitude. The resulting output was about 2 mV, which agrees well with the calculations above for an average of one photon per cycle. When the PMT high voltage was off, there was no measurable output noise as expected. In all cases, the SNR is dominated by the background count rate which exceeded the signal rate by 2 to 3.

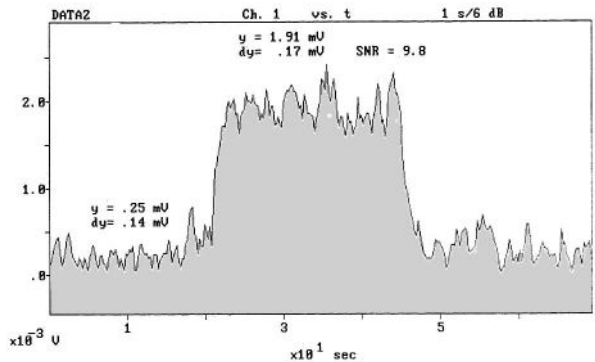
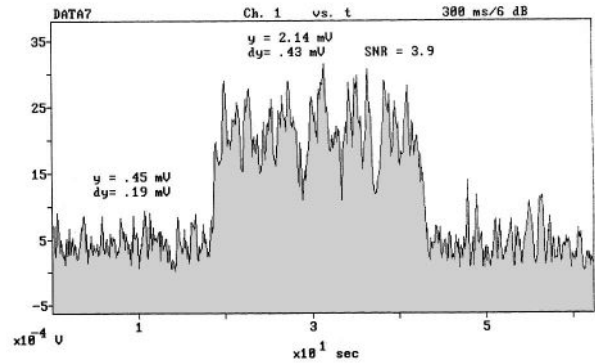
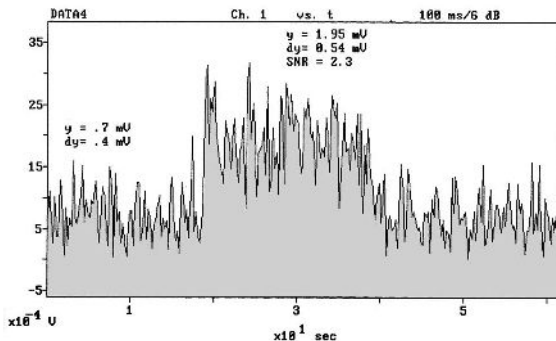

As seen from the data, a signal of 50 photons/s, at a reference of 50 Hz, is easily detected with a lock-in amplifier to the same SNR as a photon counter.

In general, large signals require the use of analog instruments such as boxcar averagers and lock-in amplifiers. While it is true that the theoretical achievable signal-to-noise ratio may not be as good as the counting statistics, the practical matter is that large signals take less time to measure to a given SNR level.

When the signal is low (less than one photon per gate or cycle), the analog instruments, with the appropriate technique, can achieve photon counting signal-to-noise ratios. When the signal is much lower photon counting is required.

In most experiments, the key to optimizing the measurement will lie in factors other than signal intensity. In all cases, the PMT quantum efficiency, gain, and noise are the most important factors. The initial gain from the PMT can never be replaced as well with an amplifier. Low background or dark count rates are essential in low-level measurements. External noise pickup in signal cables, or unstable background count rates (such as from an unstable glow discharge), can result in large fluctuations in signal amplitude: far in excess of the counting statistics. These experimental factors can be the most important considerations when choosing an instrument.

For further reading:

1. *Photomultiplier Handbook* (pub PMT-62), RCA Corp., 1980.
2. *The Art of Electronics*, Horowitz and Hill, Cambridge University Press, Cambridge, 1982.